

TECHNICAL 024EN **ekinex**

.....
INTRODUCTION
.....

The Company	07
The automation of buildings	09
The KNX standard	10
The advantages	12
The Ekinex® devices	15



We believe

in technology that makes life easier.

We develop devices that make everyday gestures easier.

Our scenario is the whole world.

We want

to combine technology and design.

To give life to something unique that combines

two seemingly distant worlds.



The Company

Technology meets design.

We offer a form without ever leaving aside its content. We present a product with a strong technological content which is also cutting edge from an aesthetic point of view. Design becomes the driving force behind technology, the key to opening our doors to the world of smart homes. We use the potential of the KNX system to guarantee high quality standards for a project we have called Ekinex®.

Our devices are developed and manufactured in Italy.

Ekinex® has created a line of objects that encloses the essence of the Made in Italy: design, attention to detail, technological innovation and advancement. Designed for a global market, Ekinex® products are an expression of the new Italian tradition, which combines the attention of craftsmanship in the creation of the product to high technological levels. Ekinex® supports the idea of a design that is not just an aesthetic exercise, but one that understands, as fundamental factors, ease of use, immediate understanding of the function and the balanced and intelligent application of technology.

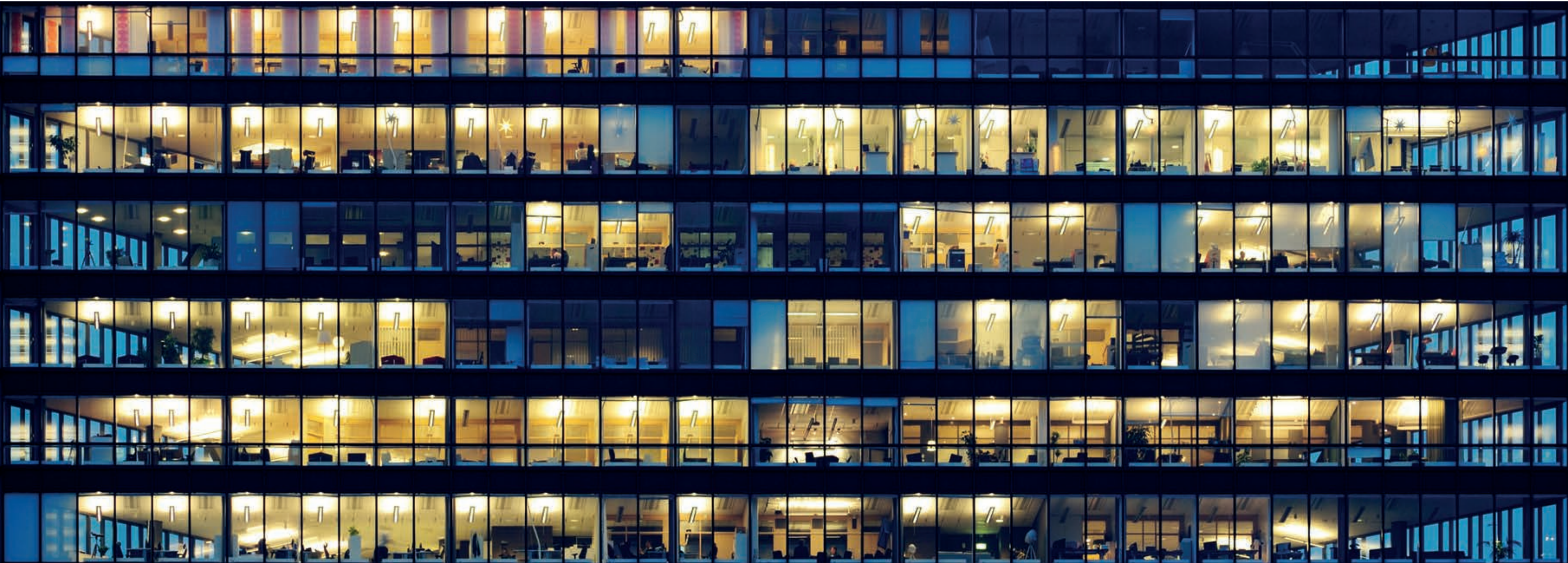

The automation of buildings

Ekinex® is an intelligent system for controlling homes and buildings, developed in accordance with the open KNX standard. Having an Ekinex® system means **to increase comfort and safety, reduce energy consumption and raise the long-term value of a building** using products characterized by fine aesthetics and a great simplicity of use.

Setting up an Ekinex® system is easy: a signal network is arranged at project level, reaching all those areas where commands, sensors or loads to be system-controlled are expected. The arrangement, achieved by means of a simple signal cable, represents an authentic network for the exchange of information between Ekinex® devices.

The scalability, typical of Ekinex® building control systems, even allows to start off with a basic equipment, both in terms of functions and devices, which may be extended at a later stage, depending on individual requirements, the location's infill and economic availability. **The investment is quickly paid back, and is protected in time.** Thanks to the native openness and interoperability of the KNX standard, the system can even integrate functions that may not be available within the Ekinex® range of products.



500 MEMBERS
30 YEARS OF EXPERIENCE
45 NATIONAL GROUPS
8000 PRODUCTS
120565 PARTNERS IN 186 COUNTRIES
511 TRAINING CENTRES IN 72 COUNTRIES

The KNX standard

Great developments in the field of home and building automation were made possible especially thanks to an open, modular and interoperable standard like KNX. This innovative standard was born from the merging of three European systems (EIB, BatiBUS and EHS), developed and brought to the market in the early 90's. The diffusion of the system was facilitated by an intense work of cooperation at normative level in the standard committee at European level. For this reason, too, **KNX is a standard characterized by a total conformity with norm EN 50090** on electronic systems for the control of homes and buildings (HBES, Home and Building Electronic Systems).

The twenty-year presence on the market of this standard offers the best guarantee in terms of reliability and consolidation of the technology used. The openness of the standard and that of the KNX Association, on the other hand, ensure availability of products in the long run and a constant development, both in terms of technology and offering of products, functions and applications.

The vitality of KNX proposals is witnessed by the sustained expansion of the association, seeing the entry of manufacturers, coming from many different areas, and from the tens of thousands of technicians who chose it to specialize in the field of building automation.

Achievable savings with the adoption of the KNX system for Home & Building control:

- 40% over shutters control**
- 50% over individual ambient control**
- 60% over ambient lighting control**
- 60% over ventilation control**

For customers, the variety and availability of KNX products has no comparison in other technological areas, and the system openness translates into the highest free choice, thereby avoiding the disadvantageous dependence of having to buy from a single supplier. Thanks to the modularity of the system, a project can be extended in time, starting with a basic configuration and adding more functions later. **The native interoperability of KNX products is fundamental to technicians**, as it allows to design a system by always choosing the most suitable technical options, reducing compromise and ties caused by isolated systems which do not converse with one another. **Moreover, the system offers new professional opportunities to designers and system integrators, making it possible to receive a consistent and high-level technical training and become certified KNX Partners.**



The KNX standard is entirely compliant with norm EN 50090 on HBES (Home and Building Electronic Systems) systems)

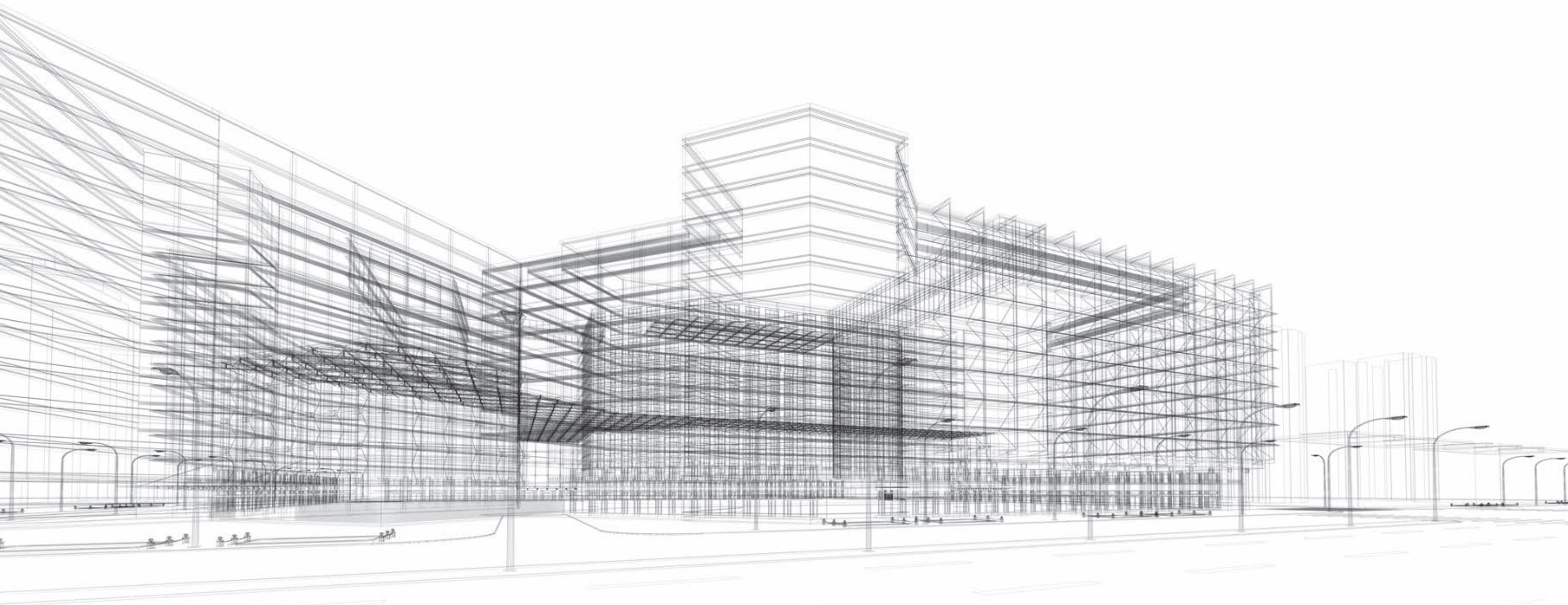

The advantages

Design, realize and use a home & building control plant with the KNX system has many advantages.

Designer

- Compliant, open, interoperable system
- Can be used in all types of buildings, from small residential to large service industry ones
- Devices, from over 300 manufacturers, communicating between each other in native mode
- Constant expansion of available functions and applications
- System design by means of standard software (ETS), manufacturer-independent
- Easy realization of commands, controls, supervisions and displays
- Wide availability of complex logic
- Interfacing towards numerous other systems, protocols and standards
- Simple logic connections between functions and devices
- Large choice of device parametrizing options based on single requirements
- Reduction of building's fire load
- Certified training, standardized and available worldwide

Installer

- Reduced device assembly and cabling times
- Unique, fast connection system (cable and bus terminal block) for all manufactures
- High quality and reliability of products (consolidated system)
- Configuration and service commissioning by means of standard, manufacturer-independent software (ETS)
- Speed and flexibility in the expansion and the modification of use
- Remote access for maintenance and diagnosis interventions
- Reduction of cables needed for command, control and distribution circuits
- Certified training, standardized and available worldwide
- Opportunities for professional advancements
- Access to the world of innovative systems

User

- Large choice of products
- High comfort, great operation safety
- More information, verification of own consumption habits
- Coordinated working of all building systems
- Multifunctional deployment of several devices
- System scalability and modularity
- Easy upgrading, without needing interventions on cabling nor masonry works
- Independence from single manufacturer
- More efficient building energy class (as per EN 15232)
- Easy system adaptations in case of changing needs
- Time-protected investment (open system)
- Building increase in value



The Ekinex® devices

The range of Ekinex® KNX devices includes system devices, devices dedicated to single application functions and accessories. System devices allow basic operation of the bus system, while the devices dedicated to single application functions are developed specifically to execute the command, control and/or monitoring the technical systems in the building, like lighting, heating or shading.

They include switching, control and display units, sensors and actuators, etc. Each device is fitted internally with a communication module linking to the KNX bus. All devices are realized in multiple mounting versions (protruding or recessed walls, electric cabinets or panels on DIN rails as per EN 60715) in accordance with their destination of use and with the main installation modality. The KNX certification guarantees the interoperability among the devices of different KNX manufacturers. The entire procedure is disciplined by the certification system developed by the KNX Association and is based on conformity tests carried out by third-party laboratories. The tests verify that the devices support the KNX protocol and that any information is coded in accordance with KNX specifications

The presence of a KNX trademark on Ekinex® devices is a guarantee for the customer:

- Ekinex® respects the quality management system in accordance with ISO 9001;
- The devices are compliant with the European norm EN 50090-2-2, concerning fundamental aspects like electromagnetic compatibility, electrical safety and environmental conditions of use;
- They comply with indications in volumes 3 and 6 of KNX specifications;
- They comply with KNX interoperability requirements concerning standardized data type and functional blocks.

WALL-MOUNT DEVICES

Signum	19	Sensors	139
Pushbuttons	27	Motion sensor	142
		Presence sensor	143
20venti series	33	Power sockets / keystone system	147
Pushbuttons	43	Power sockets and USB	152
		Keystone system	168
FF series	49	Accessories	179
Pushbuttons	63	Rockers and front covers	180
Room thermostats	71	Thermoformed covers	186
Display Touch&See	79	Frames	187
		Plates and adapters	190
71 series	83	Templates	200
Pushbuttons	97	Mounting supports	202
Room thermostats	105		
Multisensors	108	Swiss market solutions	204
		Material and finishes	214
Touch&Control	112	Fenix NTM®	215
Touch&Control 4"	119	Orders and symbols	216
Hotel solutions	123		
Card reader	130		
Card holder	131		
Cards programmer	132		
Accédo software	134		
Smart card	135		
Tosibox®	136		



.....
SIGNUM
.....
WALL-MOUNT DEVICES

Deep	22
Surface	24



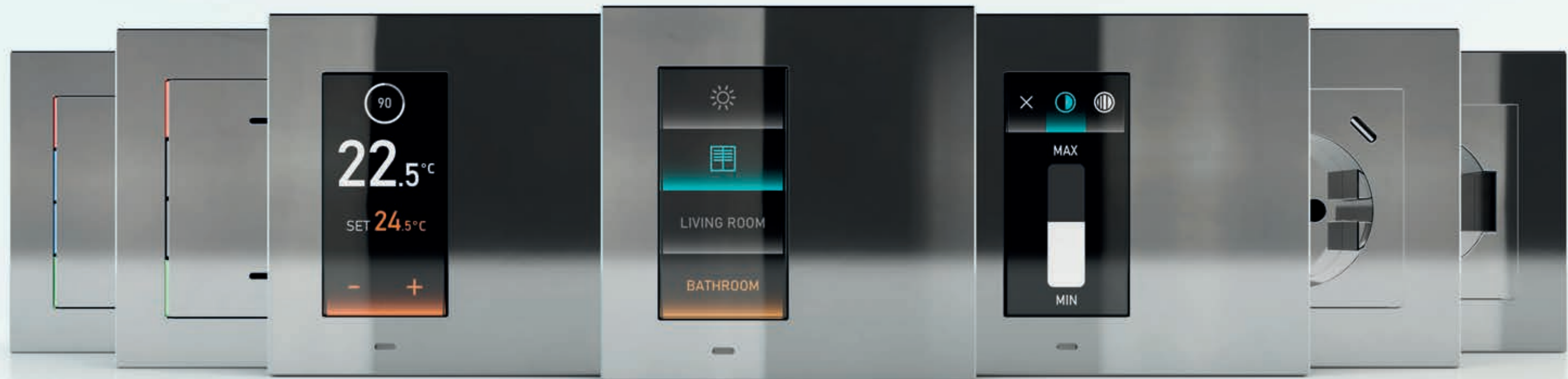

Signum Deep

WALL-MOUNT DEVICES
COMING SOON

New KNX standard “virtual” pushbutton controls with graphic colour display, haptic feedback, touch interface, borderless display, Bluetooth LE (Low Energy) for customising text and graphics from mobile device apps. In perfect family feeling with the 20venti Deep series.

Available colour solutions

	Deep	Surface
		Plate
Plastic	-	-
Metal	•	•
Metal HT	•	•
Fenix NTM®	•	•

For more information see page 214



87 x 87 x 97 mm



87 x 87 x 97 mm



87 x 87 x 9 mm



87 x 87 x 9 mm



30 x 60 mm
45 x 45 mm
55 x 55 mm
60 x 60 mm

87 x 87 x 9 mm



68 x 45 mm
55 x 55 mm
60 x 60 mm

128 x 87 x 9 mm

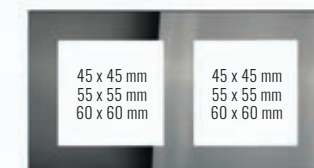

45 x 45 mm
55 x 55 mm
60 x 60 mm

158 x 87 x 9 mm

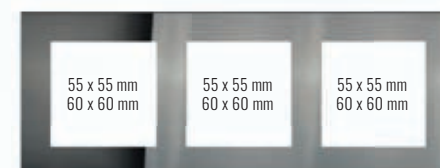

55 x 55 mm
60 x 60 mm

229 x 87 x 9 mm
3 windows 55 x 55 mm or 3 windows 60 x 60 mm

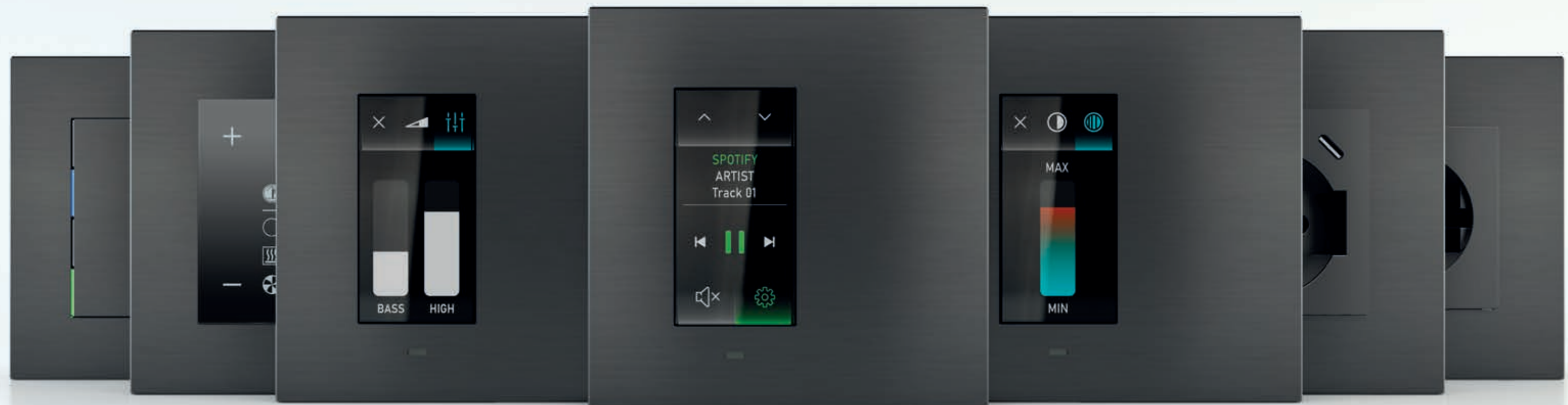

Signum Surface

WALL-MOUNT DEVICES
COMING SOON

New KNX standard “virtual” pushbutton controls with graphic colour display, haptic feedback, touch interface, borderless display, Bluetooth LE (Low Energy) for customising text and graphics from mobile device apps. In perfect family feeling with the 20venti Surface series.

Available colour solutions

	Deep	Surface*
	Plate	
Plastic	-	-
Metal	•	•
Metal HT	•	•
Fenix NTM®	•	•

* The Fenix NTM® colour effect on the Surface plate is achieved by painting
For more information see page 214

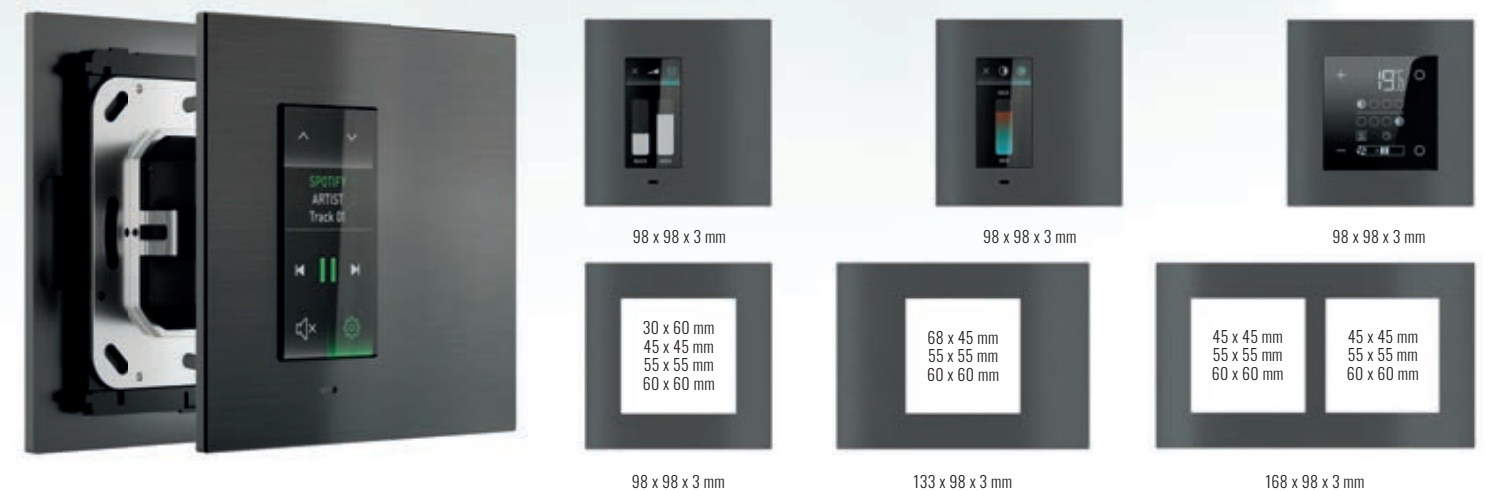

98 x 98 x 3 mm

98 x 98 x 3 mm

98 x 98 x 3 mm

30 x 60 mm
45 x 45 mm
55 x 55 mm
60 x 60 mm

68 x 45 mm
55 x 55 mm
60 x 60 mm

45 x 45 mm
55 x 55 mm
60 x 60 mm

45 x 45 mm
55 x 55 mm
60 x 60 mm

98 x 98 x 3 mm

133 x 98 x 3 mm

168 x 98 x 3 mm

Pushbuttons Signum

WALL-MOUNT DEVICES

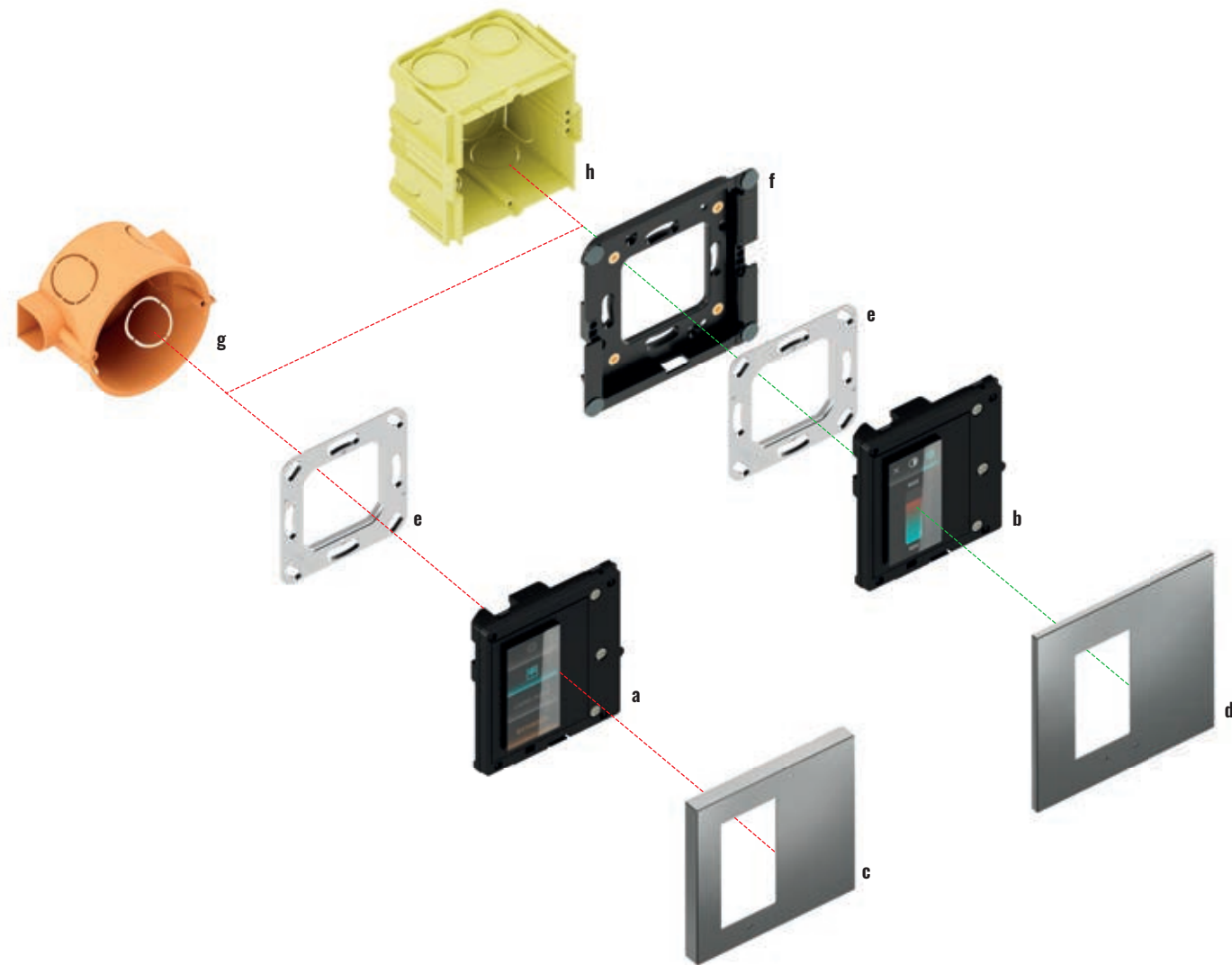

Signum

Description	Code
a) Signum pushbutton Deep version	EK-EV3-TP
b) Signum pushbutton Surface version	EK-EV3-TP
c) Square plate Deep version (30 x 60 mm window)	EK-DQZ-...
d) Square plate Surface version (30 x 60 mm window)	EK-SQZ-...
e) Metal mounting support Deep version	EK-SMQ-71-S
f) Mounting support Surface version (included in delivery)	
g) Round flush-mounting box	not delivered by Ekinex®
h) Square flush-mounting box	not delivered by Ekinex®



The "virtual" pushbutton controls of the Signum series and their accessories offer the possibility of numerous variants to meet the most diverse requirements.

The EK-EV3-TP "virtual" pushbutton, which contains a KNX communication module inside, is suitable for mounting on a round or square wall flush-mounting box, provided with fixing holes with a centre distance of 60 mm. Each button is supplied with a metal mounting bracket, which can also be ordered separately if required; a terminal for connection to the bus line completes the supply.

The pushbutton is completed with a Deep or Surface version plate. The 2.65", 162 x 320 pixel, 262K colours IPS RGB touch borderless display with haptic feedback can be configured to manage up to 4 buttons per screen and up to 3 screens in total. Each button can be customised via a dedicated app and certain attributes of each button can be changed even after installation, e.g. position, symbols and lettering. The pushbutton also offers the function of a room thermostat, thanks to the integrated temperature sensor. The proximity sensor integrated in the faceplate (to be ordered separately) provides visual comfort at night.

Configuration and commissioning of the devices is carried out using ETS® software; the relevant application programmes can be downloaded from www.ekinex.com.





Pushbuttons Signum

WALL-MOUNT DEVICES

Description

"Virtual"KNX-standard button, i.e. based on a borderless IPS touch display, in which each button can be customised via a dedicated app. It is possible to modify certain attributes of each button even after installation, e.g. position, symbols and lettering.

Main features

- Up to 4 buttons per screen and up to 3 screens in total can be configured
- Haptic pressure feedback
- Control and dimming of lighting devices
- Control of motorised drives (such as roller shutters, awnings blinds or shutters)
- Partially programmable attributes for each button
- 2.65" IPS RGB display, 162 x 320 pixels, 262K colours with haptic feedback
- Bluetooth BLE module for connection to programming app
- Room temperature detection via integrated sensor
- Proximity sensor integrated in the faceplate (to be ordered separately)
- Room thermostat function
- Connection to bus line via KNX terminal
- Recessed wall mounting on round or square box
- Configuration via App

Technical data

- 30 Vdc power supply via KNX bus
- Stand-by current consumption: 8 mA @30Vdc / max: 35 mA @30Vdc
- Wall mounting on round or square box
- IP20 degree of protection (installed)
- Plastic housing
- Climatic classification 3K5 and mechanical classification 3M2 (according to EN 50491-2)
- Pollution degree 2 (according to IEC 60664-1)
- Dimensions: 83 x 77 x 37 mm
- Operating temperature: 5... + 45°C
- Storage temperature: 25... + 55°C
- Transport temperature: 25... + 70°C
- Relative humidity: 95% non-condensing

Delivery

Delivery includes a terminal block for connection to the bus, a plastic adapter, a metal support for installation onto round or square mounting box (fixing holes 60 mm apart), two pairs of fixing screws.

Accessories

The following accessories are available to be ordered separately:

- square plate of the Deep or Surface version with 30 x 60 mm window

Dimensions [mm]

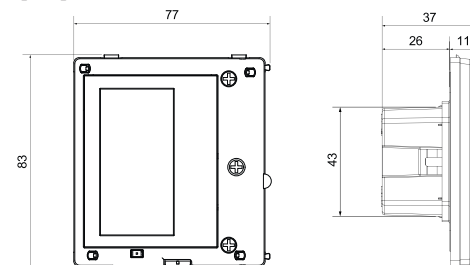

Configuration and commissioning

By means of ETS5 software or later versions
Application program: **APEKEV3TP##.knxprod**
(## = version, download from www.ekinex.com)

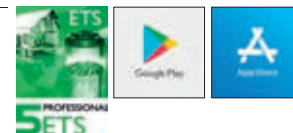

Order information

Code	Version	Mounting
EK-EV3-TP	Deep / Surface	without frame
EK-EV3-TP-TER	Deep / Surface with thermostat voucher	without frame
EK-EV3-TP-H	Deep / Surface with humidity sensor	without frame
Code	Voucher	
EK-EV3-V1-TER	Voucher to enable graphic display of thermostat function	
EK-EV3-V1-AUD	Voucher to enable the graphic display of the audio function	



Documentation

For more information see the technical documentation, download from www.ekinex.com

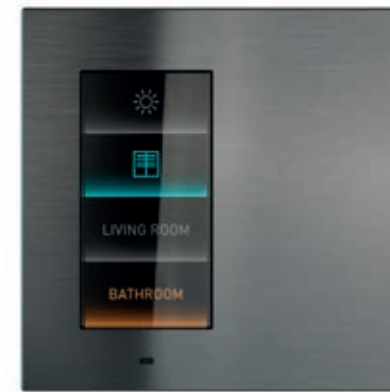

4 buttons page

Pushbuttons can be used to control devices lighting devices, scenarios and motorised drives.

A long press can call up graphic pages for precise control of home automation elements.



Brightness control page

The graphic slider allows precise control of motorised or luminescent drives in percentages.



Colour temperature adjustment page

It is possible to enable a dedicated page for controlling the hue of the light emitted by a light source. Switching from a cool colour to a warmer one will provide a completely different atmosphere.



Motorisation control page

The motorisation page allows you to control motorised locking elements using the up and down buttons.



Room thermostat page

The thermostat page, designed to be simple and intuitive, allows the room temperature to be monitored and the desired temperature to be controlled.



Air conditioning page

The air conditioning page allows you to monitor the cooling temperature of the room, control the desired temperature, position of the fins and the ventilation speed.

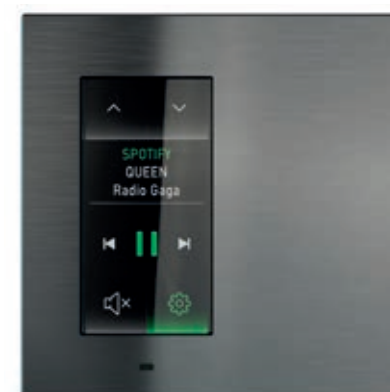

Audio page

The audio page allows you to select an audio source, change the track currently playing and to raise or lower the volume.



Audio settings page

The audio settings page also allows control the volume level and equalisation of treble and bass. treble and bass equalisation.

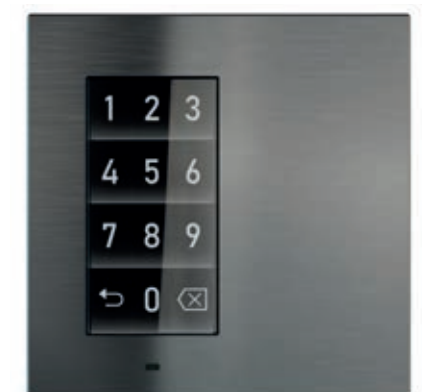

PIN Code Protection Page

The PIN code protection page allows only authorised users to use the various commands and functions.

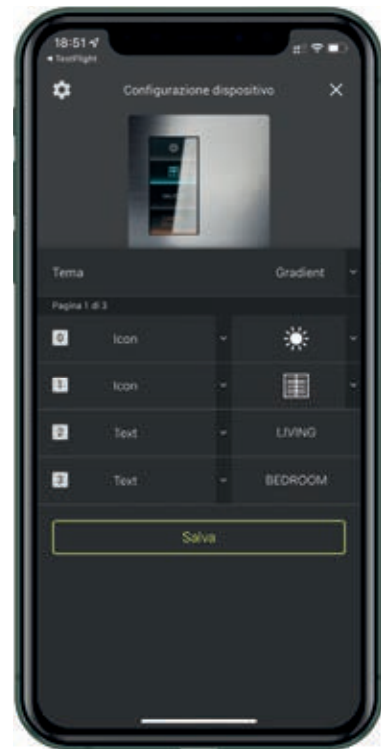

EKINEX TOOL™ APP CONFIGURATION
Main Page

From the main page, you can select the theme (Gradient or Flat) and customise the texts and symbols of the virtual buttons.

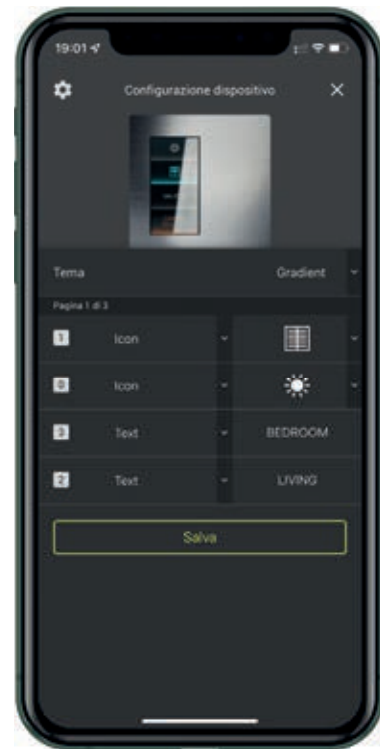

EKINEX TOOL™ APP CONFIGURATION
Pushbutton customisation page

With a horizontal swipe you can scroll between the screens of the device and customise the related pushbuttons.

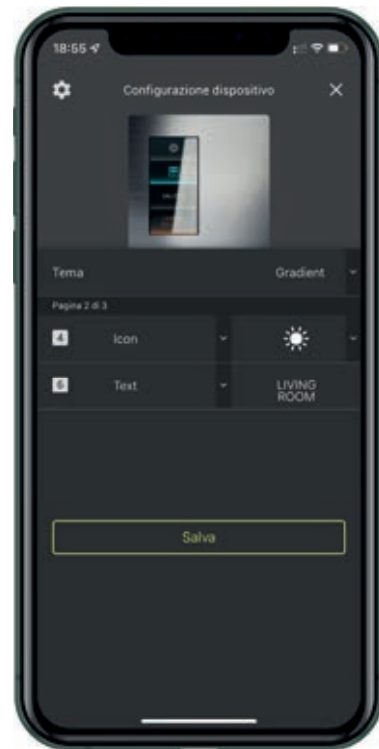

EKINEX TOOL™ APP CONFIGURATION
Symbol library page

The application gives access to a continuously updated library of 120 symbols.

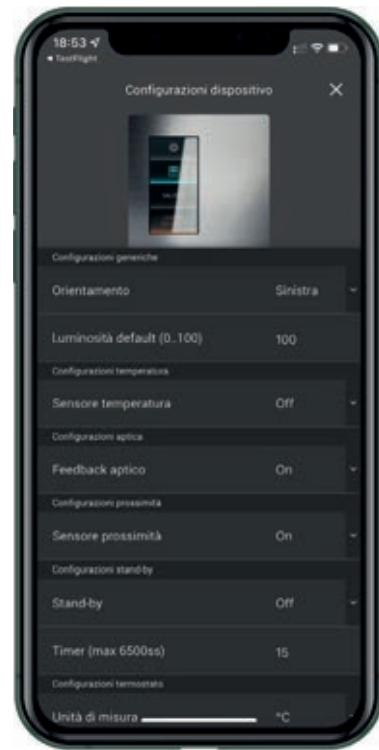

EKINEX TOOL™ APP CONFIGURATION
Settings page

From the settings page, the main operating parameters of the device can be configured: display brightness, sensor enablement haptic feedback and stand-by time.



RELAX

KITCHEN

PLAYER

ALL OFF

20VENTI SERIES

WALL-MOUNT DEVICES

Deep	36
Surface	38





20venti Deep

WALL-MOUNT DEVICES

Intuition, flexibility and continuous growth. 20venti series in its Deep version represents an evolution of the compact and essential design of 71 series, enriched with new features that facilitate the recognition of functions from the first use. The materials used are plastic, metal, Metal HT and the nanotechnological Fenix NTM®.

Available colour solutions

	Deep	Surface	Rockers
	Plate		
Plastic	•	-	•
Metal	•	•	-
Metal HT	•	•	-
Fenix NTM®	•	•	-

For more information see page 214

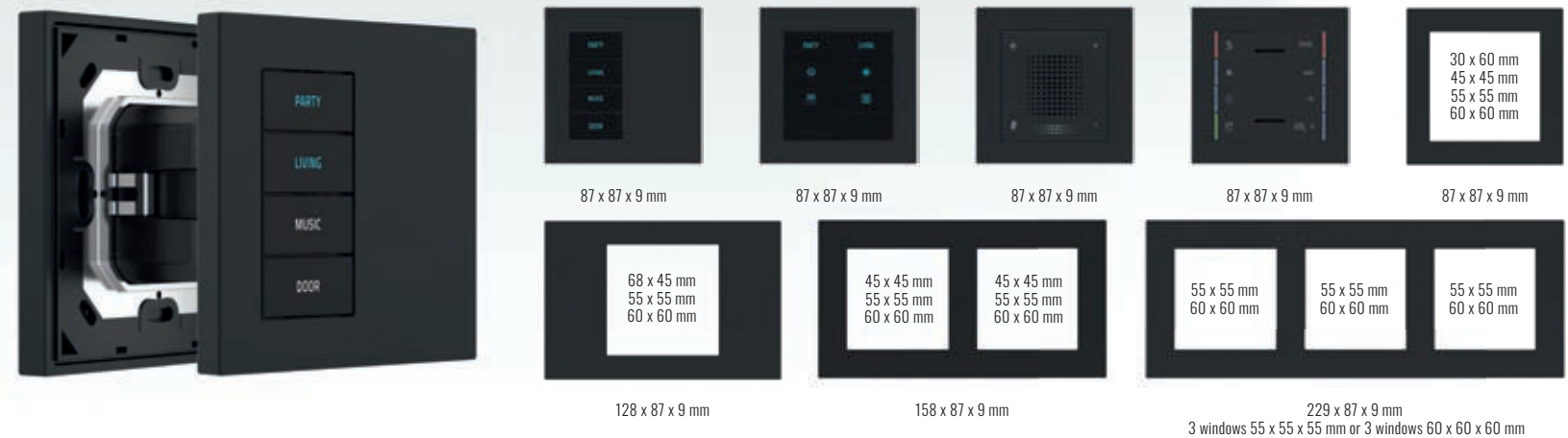

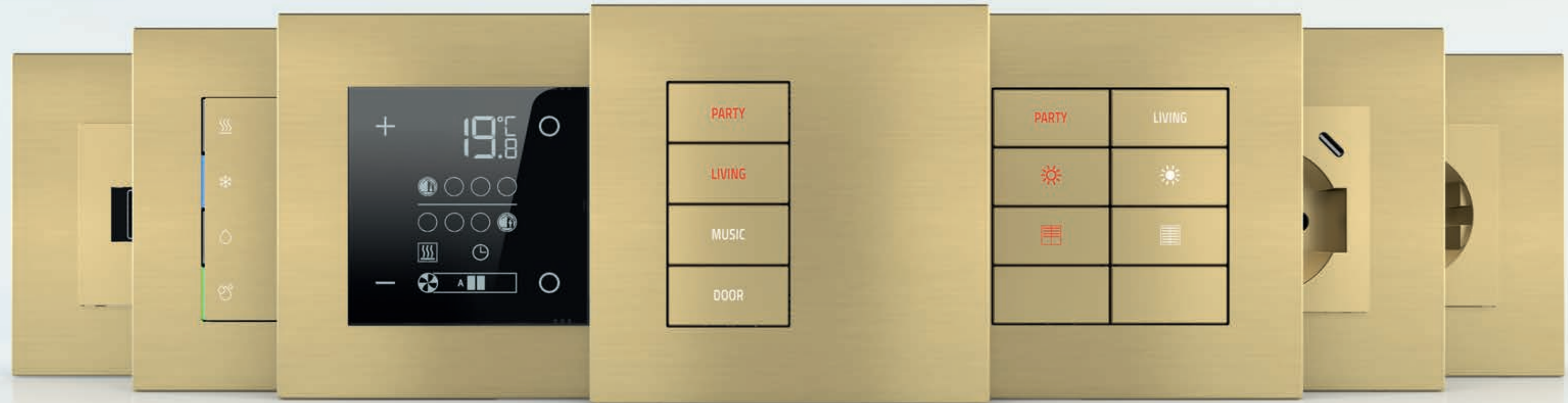

20venti Surface

WALL-MOUNT DEVICES

Essentiality and functionality in a single product. 20venti series in its Surface version represents an evolution of the compact and essential design of 71 series but is enriched with new features that make it easier to recognize the functions of the keyboard from the first use. The materials used are plastic, metal, Metal HT and the nanotechnological Fenix NTM® that make it a contemporary proposal that finds its place in homes, offices and hotels.

Available colour solutions

	Deep	Surface	Rockers
	Plate		
Plastic	•	-	•
Metal	•	•	-
Metal HT	•	•	-
Fenix NTM®	•	•	-

For more information see page 214

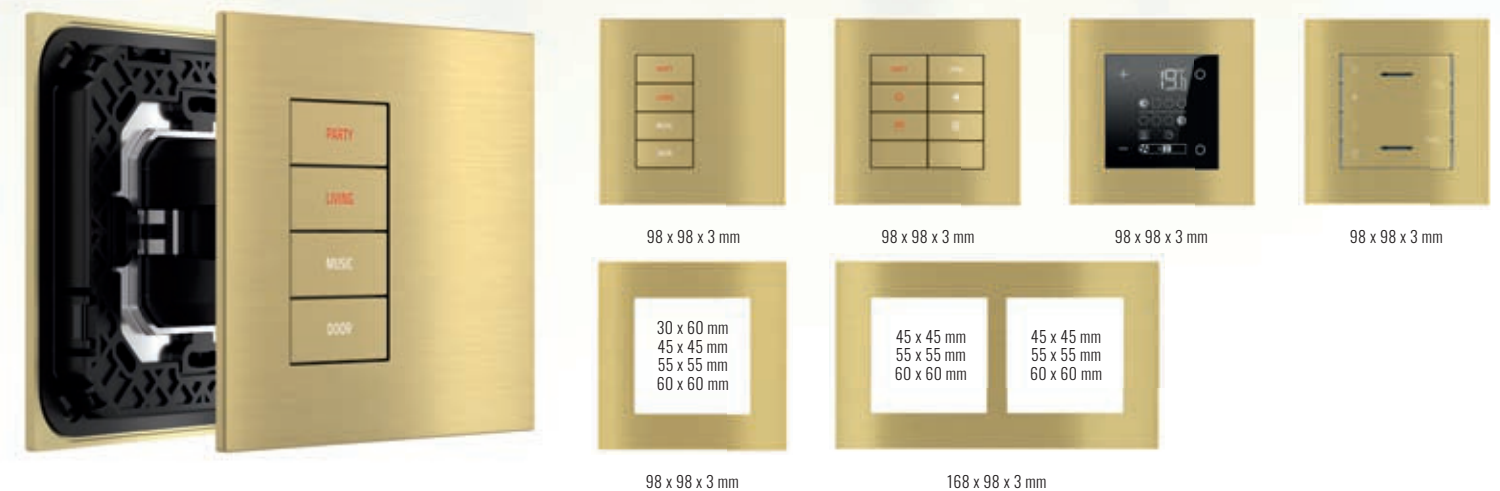

98 x 98 x 3 mm

98 x 98 x 3 mm

98 x 98 x 3 mm

98 x 98 x 3 mm

30 x 60 mm
45 x 45 mm
55 x 55 mm
60 x 60 mm

45 x 45 mm
55 x 55 mm
60 x 60 mm

45 x 45 mm
55 x 55 mm
60 x 60 mm

98 x 98 x 3 mm

168 x 98 x 3 mm

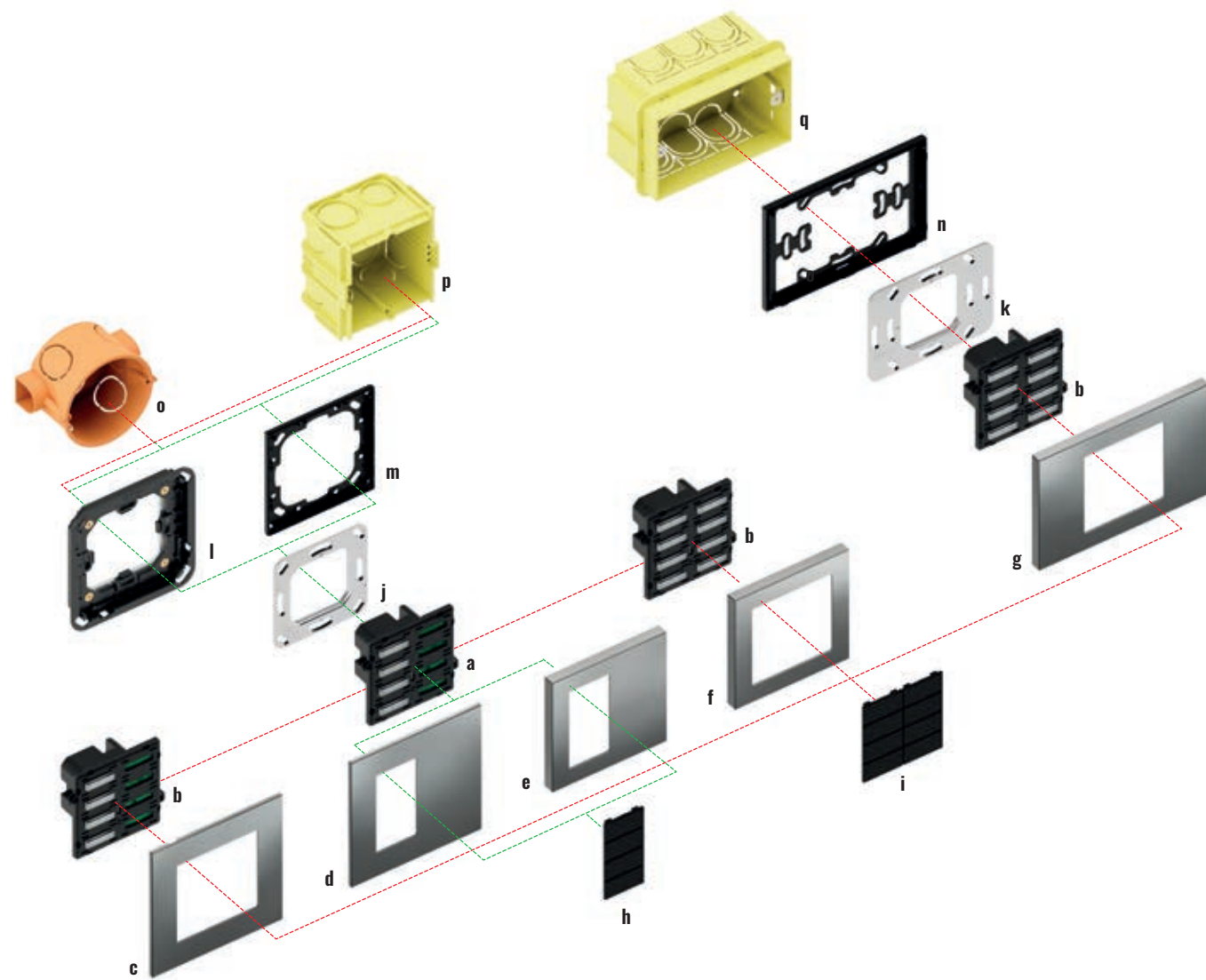

Pushbuttons 20venti series with backlit text/symbols and proximity sensor (4/8 rockers)

Description	Code
a) Pushbuttons 20venti series with backlit text/symbols and proximity sensor 4 rockers	EK-E2E-TP-4L
b) Pushbuttons 20venti series with backlit text/symbols and proximity sensor 8 rockers	EK-E2E-TP-8
c) Square plate Surface version (60 x 60 mm window)	EK-SQS-...
d) Square plate Surface version (30 x 60 mm window)	EK-SQT-...
e) Square plate Deep version (30 x 60 mm window)	EK-DQT-...
f) Square plate Deep version (60 x 60 mm window)	EK-DQS-...
g) Rectangular plate Deep version (60 x 60 mm window)	EK-DRS-...
h) Rectangular rockers (4 pcs)	EK-T4R-20-...

Description	Code
i) Rectangular rockers (8 pcs)	EK-T4R-20-...
j) Metal mounting support	EK-SMQ-71-1
k) Metal mounting support with adapter	EK-SMR-71-1
l) Adapter for square Surface plate	EK-TAS-Q-W or EK-TAS-Q-N
m) Adapter for square plate 'NF' and Deep version	EK-TAQE-1-NF
n) Adapter for rectangular plate 'NF' and Deep version	EK-TAR-1-NF
o) Round flush-mounting box	not delivered by Ekinex®
p) Square flush-mounting box	not delivered by Ekinex®
q) Rectangular flush-mounting box (3 modules)	not delivered by Ekinex®

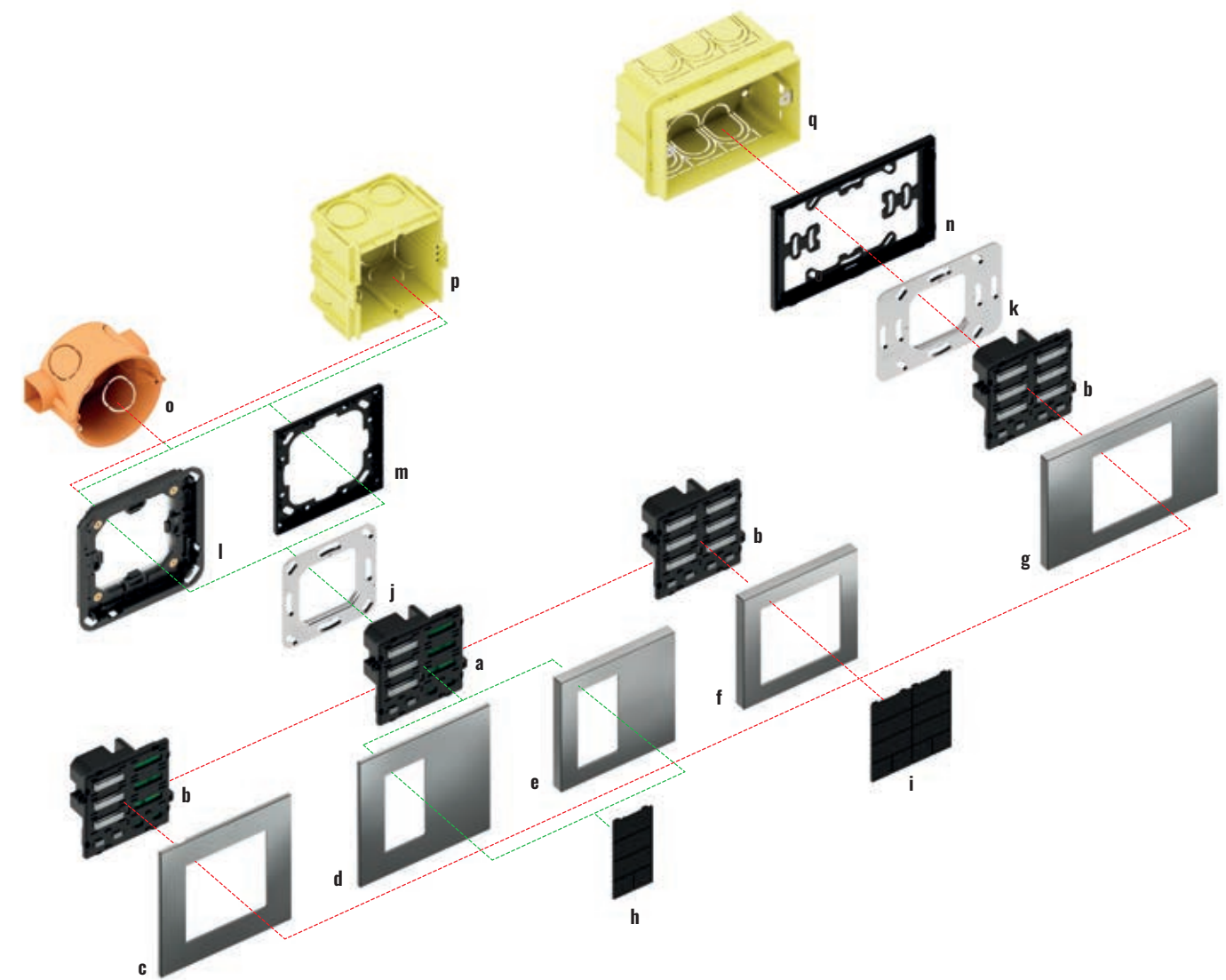

Pushbuttons 20venti series with backlit text/symbols and proximity sensor (5/10 rockers)

Description	Code
a) Pushbuttons 20venti series with backlit text/symbols and proximity sensor 5 rockers	EK-E2E-TP-5L
b) Pushbuttons 20venti series with backlit text/symbols and proximity sensor 10 rockers	EK-E2E-TP-10
c) Square plate Surface version (60 x 60 mm window)	EK-SQS-...
d) Square plate Surface version (30 x 60 mm window)	EK-SQT-...
e) Square plate Deep version (30 x 60 mm window)	EK-DQT-...
f) Square plate Deep version (60 x 60 mm window)	EK-DQS-...
g) Rectangular plate Deep version (60 x 60 mm window)	EK-DRS-...
h) Rectangular rockers (3 pcs) Rectangular rockers dimmer (1 pcs)	EK-T4R-20-... EK-T2B-20-...

Description	Code
i) Rectangular rockers (6 pcs) Rectangular rockers dimmer (2 pcs)	EK-T4R-20-... EK-T2B-20-...
j) Metal mounting support	EK-T2B-20-...
k) Metal mounting support with adapter	EK-SMQ-71-1
l) Adapter for square Surface plate	EK-SMR-71-1
m) Adapter for square plate 'NF' and Deep version	EK-TAS-Q-W or EK-TAS-Q-N
n) Adapter for rectangular plate 'NF' and Deep version	EK-TAQE-1-NF
o) Round flush-mounting box	not delivered by Ekinex®
p) Square flush-mounting box	not delivered by Ekinex®
q) Rectangular flush-mounting box (3 modules)	not delivered by Ekinex®



Pushbuttons 20venti series

WALL-MOUNT DEVICES



A wider range of combinations and features.
The 20venti series pushbuttons are available on Deep and Surface plates with 4 or 8 rockers modularity and built-in RGB LEDs to create any colour shade. Buttons with 5 or 10 rockers modularity are also available for dimming lights or managing shutters.

The Ekinex® 20venti pushbuttons' series controls offer the possibility of numerous variants to meet the most diverse requirements. The basis is represented by the pushbutton that contains a KNX communication module inside. The EK-E20-TP-... is suitable both for mounting on a round or square wall-mounting box with fixing holes with 60 mm centre distance, and for mounting on a 3-place Italian standard rectangular wall-mounting box with fixing holes with 83.5 mm centre distance. Each pushbutton is delivered with a terminal block and two pairs of fixing screws.

The button must be completed with its relative metal support, a plastic adapter, the keys and a plate from the Deep or Surface version. The buttons are available in rectangular shape, in plastic material. The button has integrated RGB LEDs that can be freely programmed: for example, for status indication or as a night orientation light. The device also offers the function of a room thermostat, thanks to the integrated temperature sensor. The integrated proximity sensor ensures maximum readability when using the push-button panel and allows visual comfort during the night.

The devices are configured and commissioned using the ETS® software; the relevant application programs can be downloaded from www.ekinex.com.



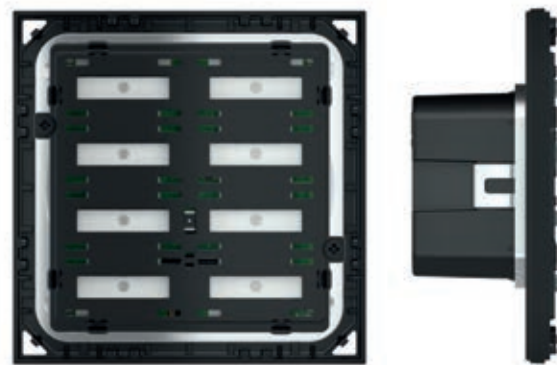

4/8-fold pushbutton with backlit text/symbols and proximity sensor 20venti series

WALL-MOUNT DEVICES

Description

The Ekinex® 20venti series 4/8-fold pushbutton is used for on/off control of utility devices, dimming of luminaires, control of motorized drives for roller shutters or other programmable control functions. Thanks to the integrated temperature sensor, the button can act as a temperature controller for a room or zone. RGB LED for each rocker. The switch has an integrated KNX bus communication module and is designed for installation in a flush-mounted wall box.

Main features

- 4/8 fold version (possibility to configure up to 4 or 8 independent functions)
- RGB LED for each freely programmable rocker
- Integrated temperature sensor
- Integrated proximity sensor
- Room thermostat function
- Plastic casing
- Connection to bus line with KNX terminal block
- Wall-mounting installation on round or square wall box
- IP20 protection degree (installed)

Technical data

- 30 Vdc power supply by KNX bus
- Current consumption from bus < 17 mA

Delivery

Delivery includes a terminal block for connection to the bus, two pairs of fixing screws.

Accessories

The following accessories are available to be ordered separately:

- 4 or 8 rectangular 30 x 15 mm plastic rockers with or without backlit text/symbol
- square plate of the Deep and Surface version with 30 x 60 mm or 60 x 60 mm window
- a plastic adapter
- a metal support for installation onto round or square mounting box (fixing holes 60 mm apart)

Dimensions [mm]

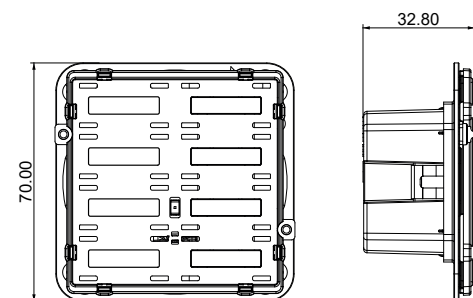

Order information

Code	LED colours	Mounting	Rockers
EK-E2E-TP-4L	RGB		4 left with backlit text/symbols
EK-E2E-TP-4R	RGB	without frame	4 right with backlit text/symbols
EK-E2E-TP-8	RGB		8 with backlit text/symbols



Configuration and commissioning

By means of ETS5 software or later versions
Application program: **APEKE2ETP##.knxprod**
(## = version, download from www.ekinex.com)



Documentation

For more information see the technical documentation, download from www.ekinex.com



8-fold pushbutton with backlit text/symbols and proximity sensor for rectangular wall-box 20venti series

WALL-MOUNT DEVICES

Description

The Ekinex® 20venti series 8-fold pushbutton is used for on/off control of utility devices, dimming of luminaires, control of motorized drives for roller shutters or other programmable control functions. Thanks to the integrated temperature sensor, the button can act as a temperature controller for a room or zone. RGB LED for each rocker. The switch has an integrated KNX bus communication module and is designed for installation in a flush-mounted wall box.

Main features

- 8 fold version (possibility to configure up to 8 independent functions)
- RGB LED for each freely programmable rocker
- Integrated temperature sensor
- Integrated proximity sensor
- Room thermostat function
- Plastic casing
- Connection to bus line with KNX terminal block
- Wall-mounting installation on round, square or rectangular wall box
- IP20 protection degree (installed)

Technical data

- 30 Vdc power supply by KNX bus
- Current consumption from bus < 17 mA

Delivery

Delivery includes a terminal block for connection to the bus, two pairs of fixing screws.

Accessories

The following accessories are available to be ordered separately:

- 8 rectangular 30 x 15 mm plastic rockers with or without backlit text/symbol
- rectangular plate of the Deep version with 60 x 60 mm window
- a plastic adapter
- a metal support for installation onto round or square (fixing holes 60 mm apart) or rectangular (fixing holes 83,5 mm apart) mounting box

Dimensions [mm]

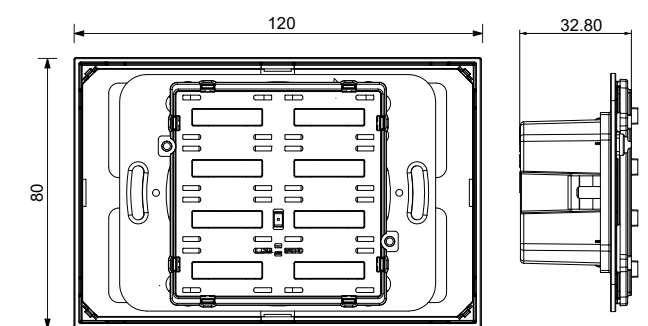

Order information

Code	LED colours	Mounting	Rockers
EK-E2E-TP-8	RGB	without frame	8 with backlit text/symbols



Configuration and commissioning

By means of ETS5 software or later versions
Application program: **APEKE2ETP##.knxprod**
(## = version, download from www.ekinex.com)



Documentation

For more information see the technical documentation, download from www.ekinex.com



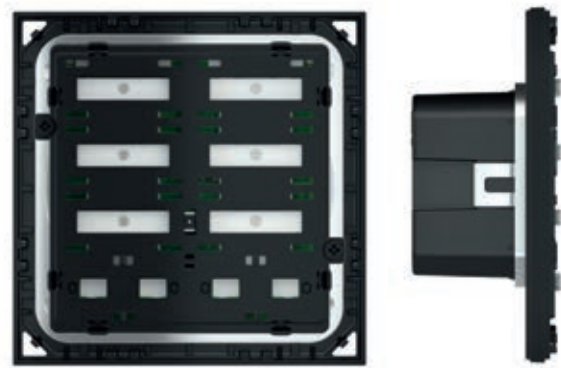

10-fold pushbutton with backlit text/symbols and proximity sensor 20venti series

WALL-MOUNT DEVICES

Description

The Ekinex® 20venti series 5/10-fold pushbutton is used for on/off control of utility devices, dimming of luminaires, control of motorized drives for roller shutters or other programmable control functions. Thanks to the integrated temperature sensor, the button can act as a temperature controller for a room or zone. RGB LED for each rocker. The switch has an integrated KNX bus communication module and is designed for installation in a flush-mounted wall box.

Main features

- 5/10 fold version (possibility to configure up to 5 or 10 independent functions including 2 or 4 functions for adjustments)
- RGB LED for each freely programmable rocker
- Integrated temperature sensor
- Integrated proximity sensor
- Room thermostat function
- Plastic casing
- Connection to bus line with KNX terminal block
- Wall-mounting installation on round or square wall box
- IP20 protection degree (installed)

Technical data

- 30 Vdc power supply by KNX bus
- Current consumption from bus < 17 mA

Delivery

Delivery includes a terminal block for connection to the bus, two pairs of fixing screws.

Accessories

The following accessories are available to be ordered separately:

- 3 or 6 rectangular 30 x 15 mm plastic rockers with or without backlit text/symbol and 1 or 2 rectangular 30 x 15 mm plastic rockers for adjustments
- square plate of the Deep and Surface version with 30 x 60 mm or 60 x 60 mm window
- a plastic adapter
- a metal support for installation onto round or square mounting box (fixing holes 60 mm apart)

Dimensions [mm]

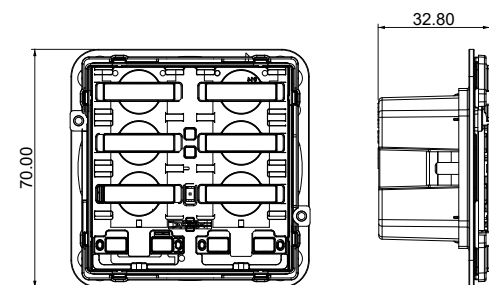

Order information

Code	LED colours	Mounting	Rockers
EK-E2E-TP-5L	RGB	without frame	3 left with backlit text/symbols 1 left for adjustments
EK-E2E-TP-5R	RGB		3 right with backlit text/symbols 1 right for adjustments
EK-E2E-TP-10	RGB		6 with backlit text/symbols 2 for adjustments



Configuration and commissioning

By means of ETS4 2.0 software (or later versions)
Application program: **APEKE2ETP##.knxprod**
(## = version, download from www.ekinex.com)



Documentation

For more information see the technical documentation, download from www.ekinex.com

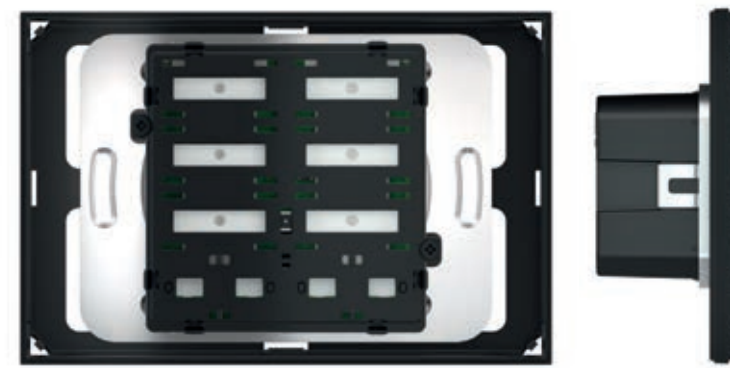

10-fold pushbutton with backlit text/symbols and proximity sensor for rectangular wall-box 20venti series

WALL-MOUNT DEVICES

Description

The Ekinex® 20venti series 10-fold pushbutton is used for on/off control of utility devices, dimming of luminaires, control of motorized drives for roller shutters or other programmable control functions. Thanks to the integrated temperature sensor, the button can act as a temperature controller for a room or zone. RGB LED for each rocker. The switch has an integrated KNX bus communication module and is designed for installation in a flush-mounted wall box.

Main features

- 10 fold version (possibility to configure up to 10 independent functions including 4 functions for adjustments)
- RGB LED for each freely programmable rocker
- Integrated temperature sensor
- Integrated proximity sensor
- Room thermostat function
- Plastic casing
- Connection to bus line with KNX terminal block
- Wall-mounting installation on round, square or rectangular wall box
- IP20 protection degree (installed)

Technical data

- 30 Vdc power supply by KNX bus
- Current consumption from bus < 17 mA

Delivery

Delivery includes a terminal block for connection to the bus, two pairs of fixing screws.

Accessories

The following accessories are available to be ordered separately:

- 6 rectangular 30 x 15 mm plastic rockers with or without backlit text/symbol and 2 rectangular 30 x 15 mm plastic rockers for adjustments
- rectangular plate of the Deep version with 60 x 60 mm window
- a plastic adapter
- a metal support for installation onto round or square (fixing holes 60 mm apart) or rectangular (fixing holes 83,5 mm apart) mounting box

Dimensions [mm]

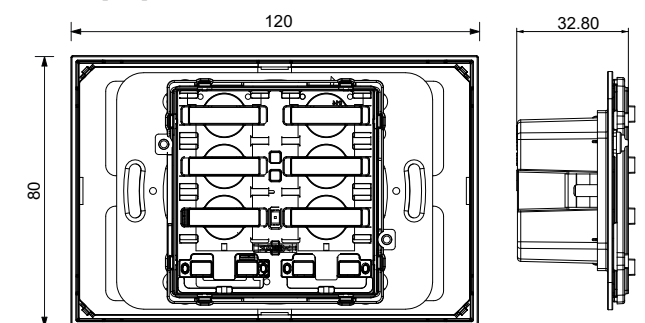

Order information

Code	LED colours	Mounting	Rockers
EK-E2E-TP-10	RGB	without frame	6 with backlit text/symbols 2 for adjustments



Configuration and commissioning

By means of ETS4 2.0 software (or later versions)
Application program: **APEKE2ETP##.knxprod**
(## = version, download from www.ekinex.com)



Documentation

For more information see the technical documentation, download from www.ekinex.com





FF SERIES
WALL-MOUNT DEVICES

Form	52
Flank	54
'NF	56
Deep	58
Surface	60



ON Ingress Lfko OFF
ON Trash Lfko OFF
ON Control Test OFF



FF Form

WALL-MOUNT DEVICES

Simple and linear. An essential form that suggests an idea of reliability and rigour. The FF series in Form version features a wide range of devices with integrated LEDs with adjustable light intensity, touch-displays, power sockets and keystone modules. The materials used are plastic, metal, Metal HT, the nanotechnological Fenix NTM® and the different finishes can be freely combined with each other.

Available colour solutions

	Form		'NF	Deep	Surface	Rockers
	Flank	Frames				
			Plates			
Plastic	•	•	•	•	-	•
Metal	•	•	•	•	•	•
Metal HT	-	-	-	•	•	•
Fenix NTM®	-	-	•	•	•	•

For more information see page 214

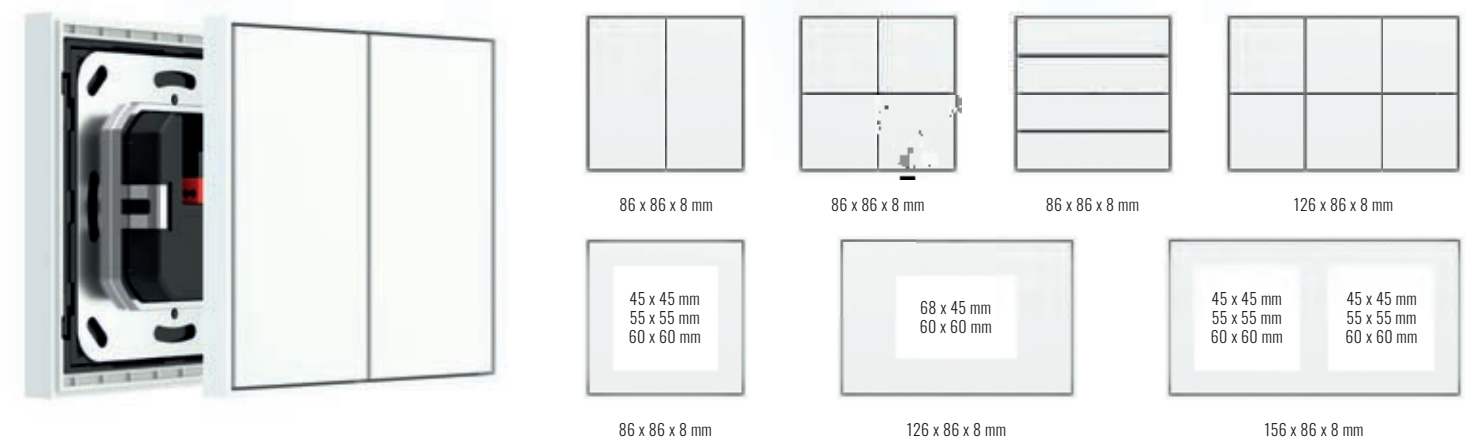



FF Flank

WALL-MOUNT DEVICES

Minimal and rigorous. Distinguished by its characteristic side edges, the Flank version of the FF series features a wide range of devices with integrated LEDs with adjustable luminous intensity, touch-displays, power sockets and keystone modules. The materials used are plastic, metal, Metal HT, the nanotechnological Fenix NTM® and the different finishes can be freely combined with each other.

Available colour solutions

	Form	Flank	*NF	Deep	Surface	Rockers
	Frames		Plates			
Plastic	•	•	•	•	-	•
Metal	•	•	•	•	•	•
Metal HT	-	-	-	•	•	•
Fenix NTM®	-	-	•	•	•	•

For more information see page 214





FF 'NF'
WALL-MOUNT DEVICES

Essential geometry in forms and a decisive trait. More than ever less is more. The range of FF series devices in 'NF' version offer the possibility to create numerous variants to meet the most different needs. Devices with integrated LEDs with adjustable luminous intensity, touch-displays, power sockets and keystone modules. The materials used are plastic, metal, Metal HT and the nanotechnological Fenix NTM®.

Available colour solutions

	Form	Flank	'NF'	Deep	Surface	Rockers
	Frames		Plates			
Plastic	•	•	•	•	-	•
Metal	•	•	•	•	•	•
Metal HT	-	-	-	•	•	•
Fenix NTM®	-	-	•	•	•	•

For more information see page 214

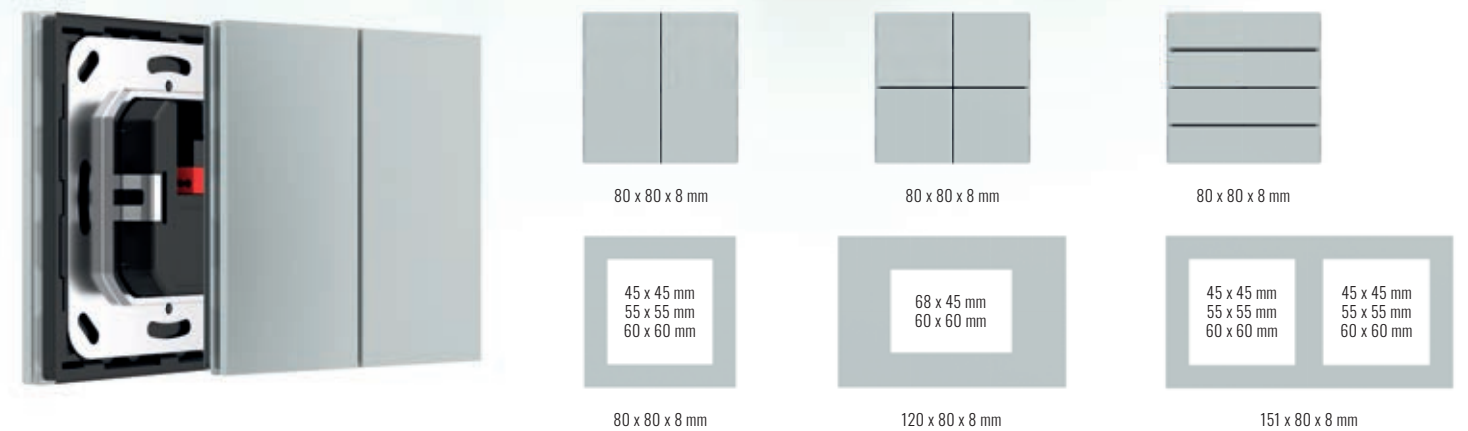



FF Deep

WALL-MOUNT DEVICES

Versatile and suitable for any setting. The Deep version of the FF series consists of devices with integrated LEDs with adjustable light intensity, touch-displays, power sockets and keystone modules. Versatile and compact, it lends itself to various combinations and blends in with all furnishing styles. The materials used are plastic, metal, Metal HT and the nanotechnology Fenix NTM®.

Available colour solutions

	Form	Flank	*NF	Deep*	Surface	Rockers
	Frames		Plates			
Plastic	•	•	•	•	-	•
Metal	•	•	•	•	•	•
Metal HT	-	-	-	•	•	•
Fenix NTM®	-	-	•	•	•	•

For more information see page 214

*) In the FF Deep we suggest the use of the pushbuttons and room thermostats of the FF - *NF series

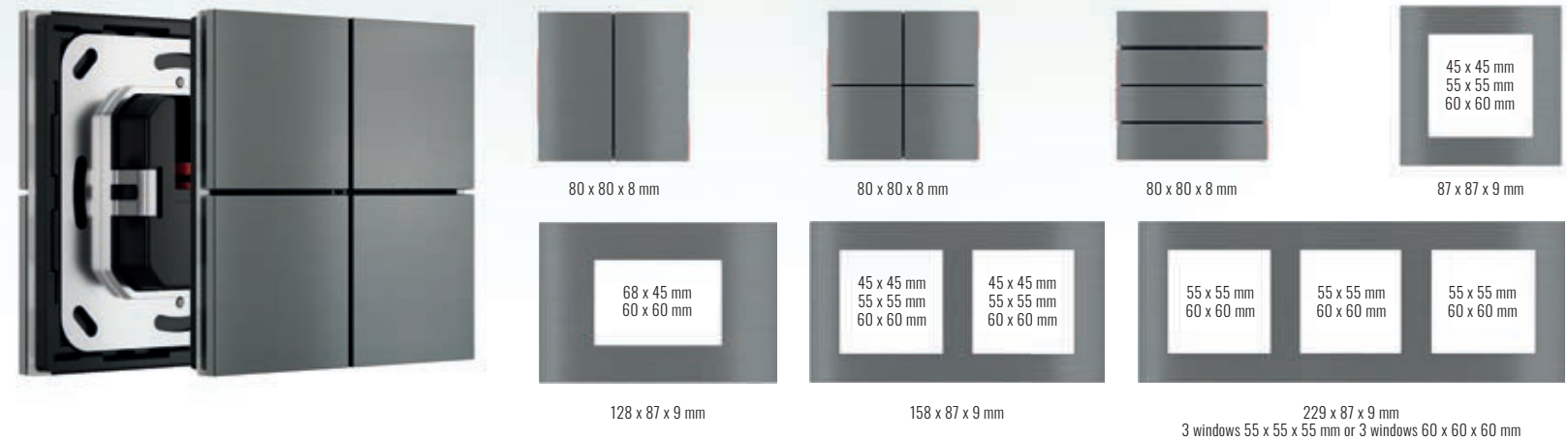

80 x 80 x 8 mm



80 x 80 x 8 mm



80 x 80 x 8 mm



45 x 45 mm
55 x 55 mm
60 x 60 mm

87 x 87 x 9 mm



68 x 45 mm
60 x 60 mm

128 x 87 x 9 mm

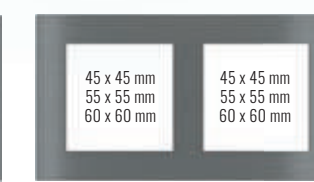

45 x 45 mm
55 x 55 mm
60 x 60 mm

158 x 87 x 9 mm

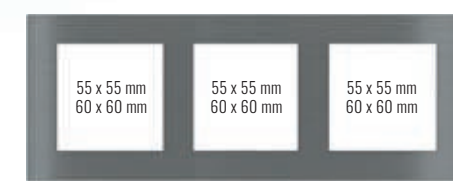

55 x 55 mm
60 x 60 mm

229 x 87 x 9 mm
3 windows 55 x 55 mm or 3 windows 60 x 60 mm

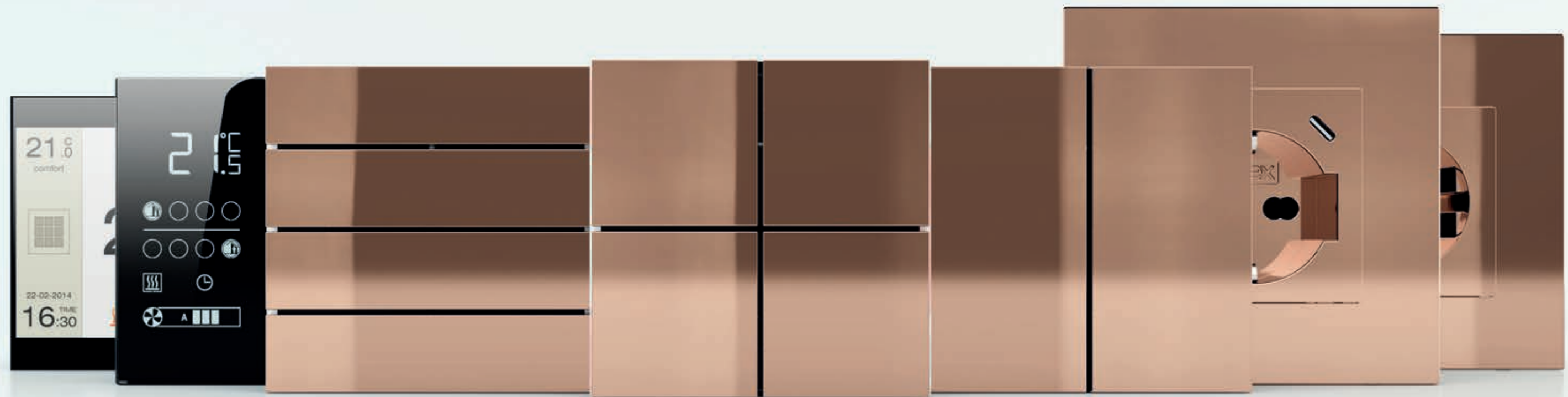

FF Surface

WALL-MOUNT DEVICES

Compact and essential. Creates a continuum with the wall in a few millimetres of thickness. The Surface version of the FF series caresses surfaces to create a uniform effect between button and wall. It consists of devices with integrated LEDs with adjustable light intensity, touch-displays, power sockets and keystone modules. Declined in materials with a strong personality such as metal, Metal HT and Fenix NTM®, it finds its ideal place in all rooms of the contemporary home.

Available colour solutions

	Form	Flank	'NF	Deep	Surface*	Rockers
	Frames		Plates			
Plastic	•	•	•	•	-	•
Metal	•	•	•	•	•	•
Metal HT	-	-	-	•	•	•
Fenix NTM®	-	-	•	•	•	•

For more information see page 214

*) In the FF Surface we suggest the use of the pushbuttons and room thermostats of the FF - 'NF series

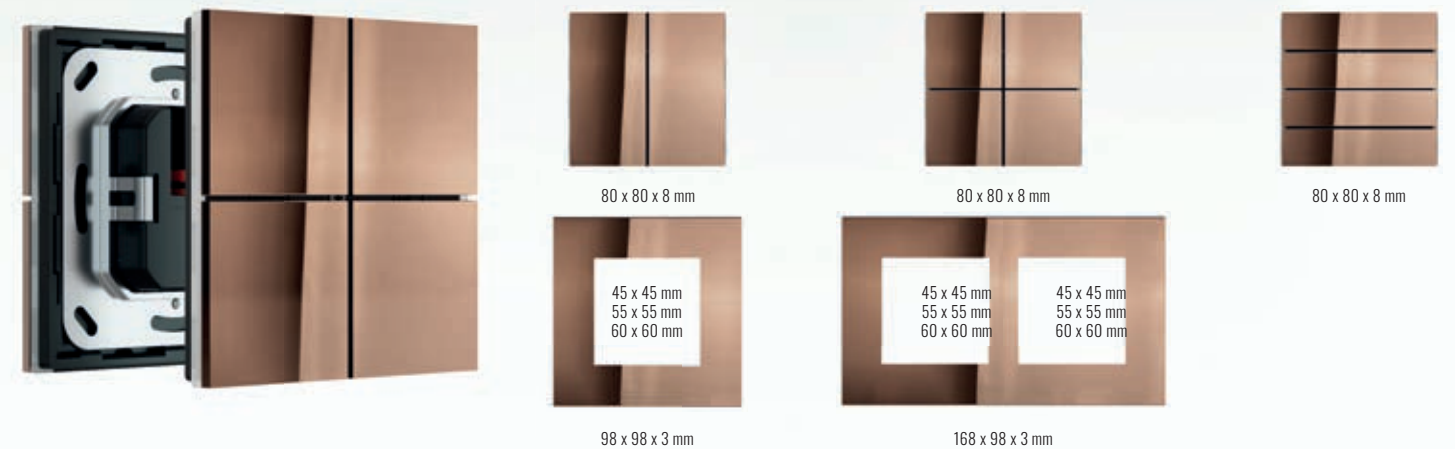

80 x 80 x 8 mm

80 x 80 x 8 mm

80 x 80 x 8 mm

45 x 45 mm
55 x 55 mm
60 x 60 mm

45 x 45 mm
55 x 55 mm
60 x 60 mm

45 x 45 mm
55 x 55 mm
60 x 60 mm

98 x 98 x 3 mm

168 x 98 x 3 mm

Pushbuttons FF series

WALL-MOUNT DEVICES

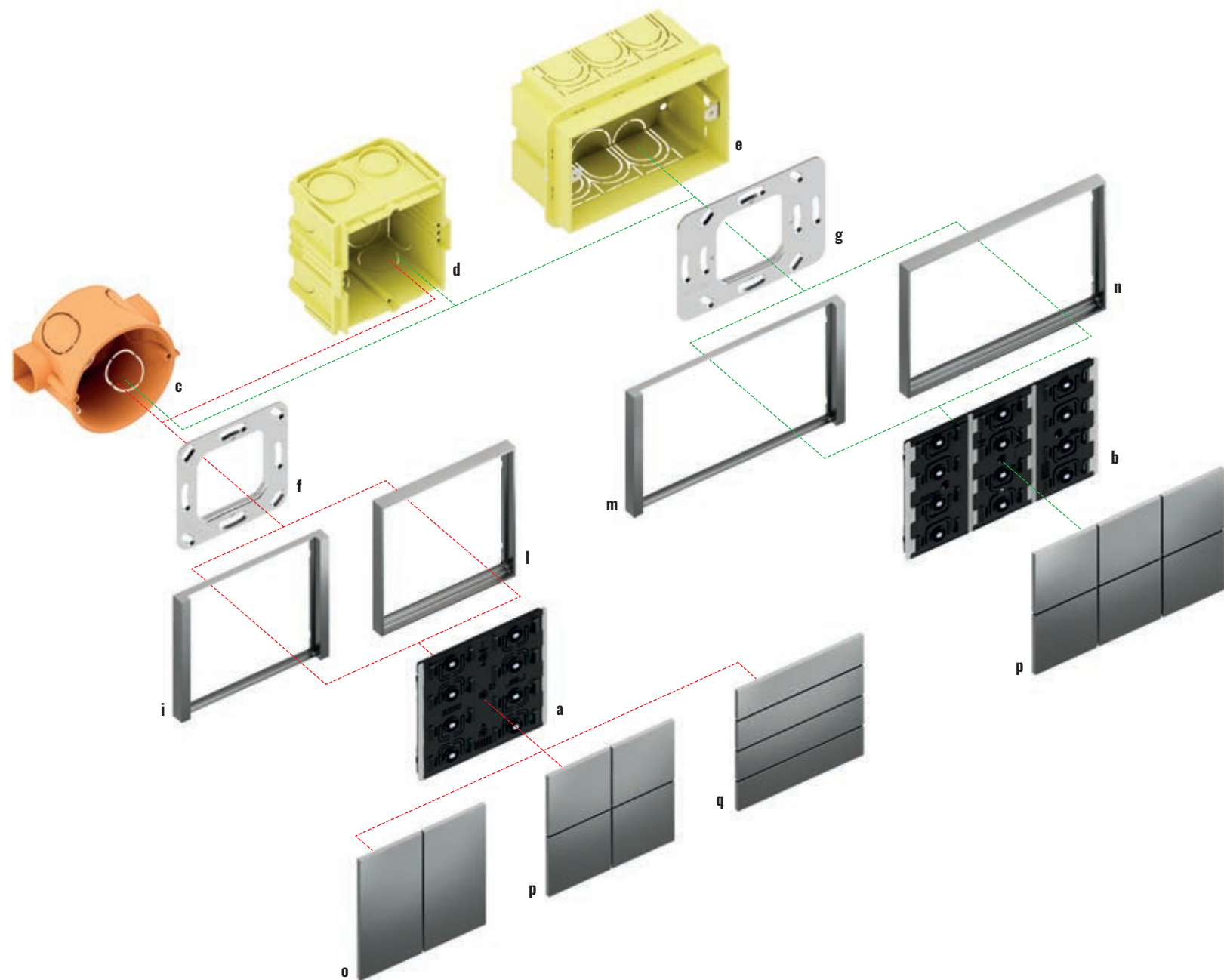

Four or six channels, square or rectangular keys, with or without frame, with or without LED, with or without temperature sensor and thermostat function. Choose the combination that best suits your needs of style and features.

The Ekinex® pushbuttons of FF series range and related accessories offer the possibility to realize several variations that will satisfy the most diverse needs. The base is represented by the 4-fold (EK-ED2-TP and EK-E32-TP) and 6-fold (EK-EH2-TP) pushbuttons; each one is fitted with a KNX communication module. The 4-fold pushbutton is suitable for mounting into a flush mounting box, either round or square, provided with fixing holes 60 mm apart, while the 6-fold version is also ideal for mounting into a rectangular wall mounting box 3 seater according to the Italian installation standard provided with fixing holes 83,5 mm apart. Each device is supplied with its relative metal support which, in case of necessity, can also be ordered separately. A terminal block complete the supply.

The pushbuttons must be finished off with an operation surface (rockers) and a frame. The rockers are available in square and rectangular shapes, plastic material, aluminium or Fenix NTM®, in several colour and finishing variations. The rockers can be personalized with symbols and texts, so to make their function immediately understandable. Versions EK-ED2-TP and EK-EH2-TP have integrated LEDs which can be programmed freely: as an example, as a status feedback or as an orientation light at night time. Two colour combinations are available for the LEDs: blue / green or red / white. The same versions also offer a room thermostat function, thanks to the integrated temperature sensor. The frames, square and rectangular, are available in two stylish alternatives (Form and Flank) and are available in plastic material or aluminium. The 'NF' version of the 4-fold pushbutton is mounted without frame and is provided with a side profile in white or black colour.

The pushbuttons simply get connected to the unique signal bus cable and do not require auxiliary power supply: the devices are supplied at SELV (Safety Extra Low Voltage) voltage, thus offering a much higher safety level than traditional commands. The configuration and commissioning is carried out by means of the ETS® software. The related application programs can be downloaded from the www.ekinex.com website.



Pushbuttons FF series

Description	Code
a) 4-fold pushbutton and room thermostat FF series	EK-ED2-TP-... or EK-E32-TP-...
b) 6-fold pushbutton FF series	EK-EH2-TP-...
c) Round flush-mounting box	not delivered by Ekinex®
d) Square flush-mounting box	not delivered by Ekinex®
e) Rectangular flush-mounting box (3 modules)	not delivered by Ekinex®
f) Metal mounting support	EK-SMQ-71-1
g) Metal mounting support	EK-SMR-71-1

Description	Code
i) Square frame Flank version	EK-FLQ-...
l) Square frame Form version	EK-FOQ-...
m) Rectangular frame Flank version	EK-FLR-...
n) Rectangular frame Form version	EK-FOR-...
o) Rectangular vertical rockers	EK-TRV-...
p) Square rockers	EK-TQQ-...
q) Rectangular horizontal rockers	EK-TRO-...



4-fold basic pushbutton FF series

WALL-MOUNT DEVICES

Description

The 4-fold pushbutton of Ekinex® FF series commands loads on/off switching, controls the dimming of lighting devices, controls motor drives for shutters or executes any other programmable command and control function. The device integrates a KNX bus communication module and is intended for mounting onto a wall mounting box: it is supplied by a SELV voltage directly from the KNX bus and does not require any auxiliary power supply.

Main features

- 4-fold (possibility to configure up to 8 independent functions)
- Plastic casing
- Wall-mounting installation
- Connection to bus line with KNX terminal block
- Frontal programming pushbutton and LED
- IP20 protection degree (installed)
- Weight 80 g (with mounting support)

Technical data

- 30 Vdc power supply through KNX bus
- Current consumption from bus < 15 mA

Delivery

Delivery includes a terminal block for connection to the bus, a metal support for installation onto round or square mounting box (fixing holes 60 mm apart) and two pairs of fixing screws.

Accessories

The following accessories are available to be ordered separately:

- square or rectangular rockers
- square frame Form or Flank version

Dimensions [mm]

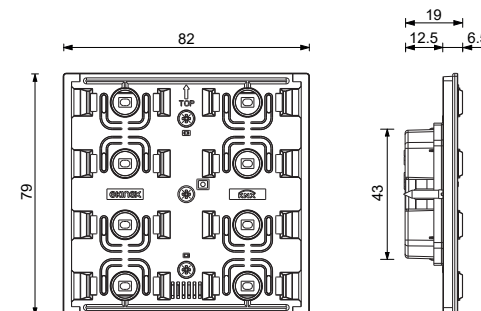

Order information

Code	Mounting	Side profile
EK-E32-TP	with square frame Form or Flank version	black
EK-E32-TP-NF	without frame ('NF version)	white
EK-E32-TP-NFW		



Configuration and commissioning

By means of ETS5 software or later versions
Application program: **APEKE32TP##.knxprod**
(## = version, downloadable from www.ekinex.com)



Documentation

For more information see the technical documentation, download from www.ekinex.com



4-fold pushbutton and room thermostat FF series

WALL-MOUNT DEVICES

Description

The 4-fold pushbutton of Ekinex® FF series commands loads on/off switching, controls the dimming of lighting devices, controls motor drives for shutters or executes any other programmable command and control function. Thanks to the integrated temperature sensor, the pushbutton can work as a thermostat for a room or a zone. The LEDs can be chosen in the colour combinations blue / green or white / red. The device integrates a KNX bus communication module and is intended for mounting onto a wall mounting box: it is supplied by a SELV voltage directly from the KNX bus and does not require any auxiliary power supply.

Main features

- 4-fold (possibility to configure up to 8 independent functions)
- 4 freely programmable LEDs for each channel
- 2 colour combination available for the LEDs (blue/green or red/white)
- Integrated temperature sensor
- Room thermostat function
- Plastic casing
- Wall-mounting installation on round or square wall box
- Connection to bus line with KNX terminal block
- Frontal programming pushbutton and LED
- IP20 protection degree (installed)
- Weight 80 g (with mounting support)

Technical data

- 30 Vdc power supply through KNX bus
- Current consumption from bus < 15 mA

Delivery

Delivery includes a terminal block for connection to the bus, a metal support for installation onto round or square mounting box (fixing holes 60 mm apart) and two pairs of fixing screws.

Accessories

The following accessories are available to be ordered separately:

- square or rectangular rockers
- square frame Form or Flank version

Dimensions [mm]

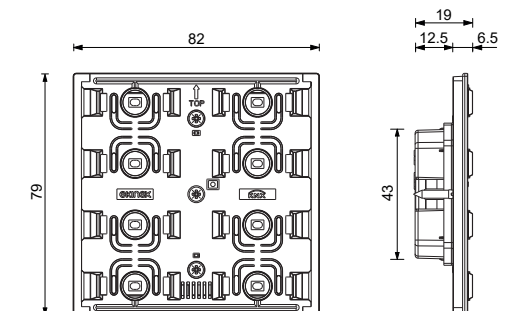

Order information

Code	LED colours	Mounting	Side profile
EK-ED2-TP	blue / green	with square frame Form or Flank version	black
EK-ED2-TP-RW	red / white		
EK-ED2-TP-BG-NF	blue / green	without frame ('NF version')	white
EK-ED2-TP-RW-NF	red / white		
EK-ED2-TP-BG-NFW	blue / green		
EK-ED2-TP-RW-NFW	red / white		



Configuration and commissioning

By means of ETS5 software or later versions
Application program: **APEKED2TP##.knxprod**
(## = version, downloadable from www.ekinex.com)



Documentation

For more information see the technical documentation, download from www.ekinex.com





6-fold pushbutton FF series

WALL-MOUNT DEVICES

Description

The 6-fold pushbutton of Ekinex® FF series commands loads on/off switching, controls the dimming of lighting devices, controls motor drives for shutters or executes any other programmable command and control function. Thanks to the integrated temperature sensor, the pushbutton can send the room temperature value on the bus to other KNX devices. The LEDs can be chosen in the colour combinations blue / green or white / red. The device integrates a KNX bus communication module and is intended for mounting onto a wall mounting box; it is supplied by a SELV voltage directly from the KNX bus and does not require any auxiliary power supply.

Main features

- 6-fold (possibility to configure up to 12 independent functions)
- 4 freely programmable LEDs for each channel
- 2 colour combination available for the LEDs (blue/green or red/white)
- Integrated temperature sensor
- Plastic casing
- Wall-mounting installation on round, square or rectangular wall box
- Connection to bus line with KNX terminal block
- Rear programming pushbutton and LED
- IP20 protection degree (installed)
- Weight 75 g (with mounting support)

Technical data

- 30 Vdc power supply through KNX bus
- Current consumption from bus < 15 mA

Delivery

Delivery includes a terminal block for connection to the bus, a metal support for installation onto round or square mounting box (fixing holes 60 mm apart) or rectangular mounting box (fixing holes 83,5 mm apart) and two pairs of fixing screws.

Accessories

The following accessories are available to be ordered separately:

- square rockers
- rectangular frame Form or Flank version

Dimensions [mm]

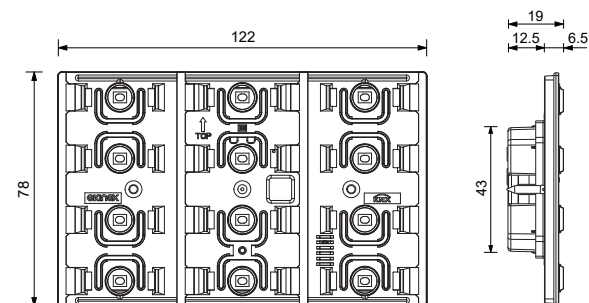

Order information

Code	LED colours	Mounting
EK-EH2-TP	blue / green	with rectangular frame Form or Flank version
EK-EH2-TP-RW	red / white	



Configuration and commissioning

By means of ETS5 software or later versions
Application program: **APEKEH2TP##.knxprod**
(## = version, downloadable from www.ekinex.com)



Documentation

For more information see the technical documentation, download from www.ekinex.com





Room thermostats

WALL-MOUNT DEVICES

Aesthetics and functionality conjugated according to the Ekinex® style.

The room temperature controls of the FF series contain the characteristics of a product with a strong technological footprint combined with a focus on aesthetic component. Available in different models, integrated LEDs and two custom keys, the Ekinex® room controllers are with their high performance able to meet the most different needs.

Available colour solutions

	Frames		Rockers
	Form	Flank	
Plastic	•	•	•
Metal	•	•	•
Metal HT	-	-	•
Fenix NTM®	-	-	•

For more information see page 214



86 x 86 x 8 mm
Form



94 x 86 x 8 mm
Flank



80 x 80 x 8 mm
NF - Deep - Surface

Room thermostats FF series

WALL-MOUNT DEVICES

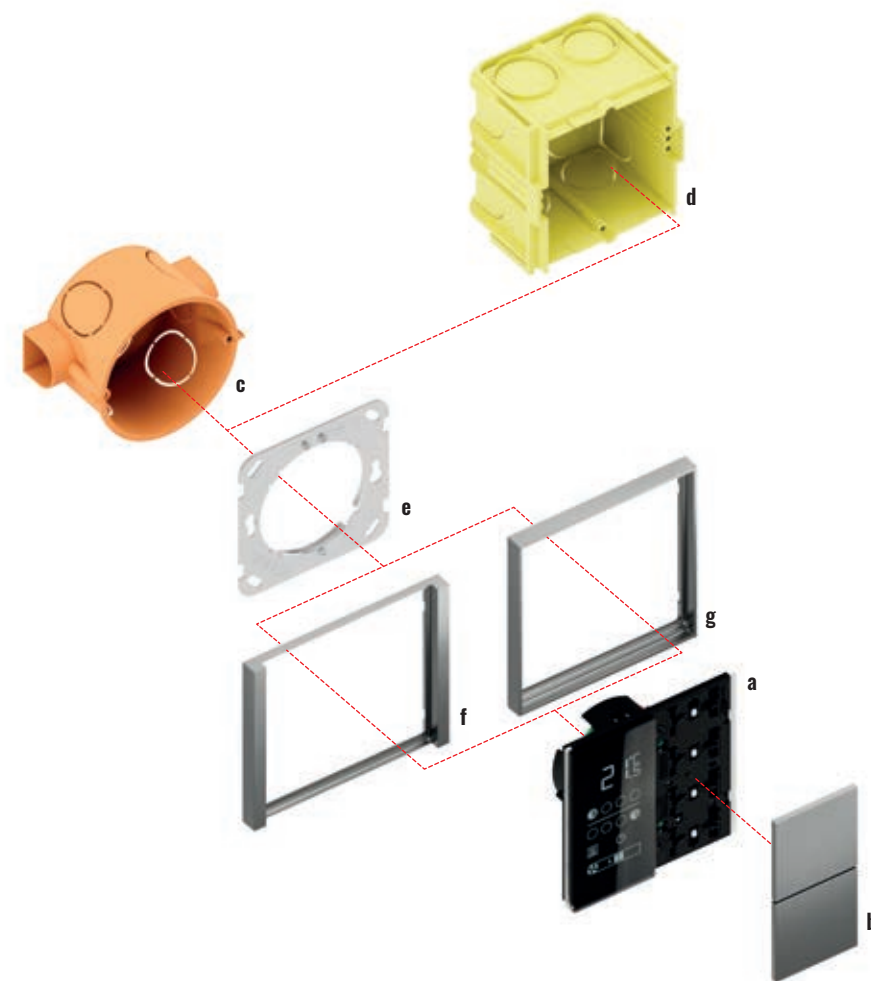

Room thermostats FF series

Description	Code
a) Room thermostat FF series	EK-ER2-TP-... or EK-EP2-TP-... or EK-EQ2-TP-...
b) Set 2 rockers for thermostat FF series	EK-TQQ-...-EP2
c) Round flush-mounting box	not delivered by Ekinex®
d) Square flush-mounting box	not delivered by Ekinex®
e) Metal mounting support	EK-SMQ-1
f) Square frame of Flank version	EK-FLQ-...
g) Square frame of Form version	EK-FOQ-...



Form, Flank, 'NF.
Three different variations for a room temperature control device with unique performance.

The Ekinex® thermostats of FF series range and related accessories offer the possibility to realize several variations that will satisfy the most diverse needs. The base is represented by the thermostats EK-ER2-TP, EK-EP2-TP and EK-EQ2-TP (with relative humidity sensor); each one integrates a KNX communication module. The device is suitable for mounting into a flush mounting box, either round or square, provided with fixing holes 60 mm apart. Each thermostat is delivered with its relative metal support which, in case of necessity, can also be ordered separately. A terminal block completes the delivery.

The pushbuttons must be finished off with an operation surface (rockers) and a frame. The rockers are available in square shape, plastic material, aluminium or Fenix NTM® in several colour and finishing variations. A special set includes two customized rockers with symbols for the thermostat functions. Each thermostat has integrated LEDs which can be programmed freely: as an example, as a status feedback or as an orientation light at night time. Two colour combinations are available for the LEDs: blue / green or red / white. The square frames are available in two stylish alternatives, Form and Flank, and share the same choice of materials, colours and finishings as for rockers. The 'NF' version of the thermostat is mounted without frame and is provided with a side profile in white or black colour.



The thermostats simply get connected to the unique signal bus cable and do not require auxiliary power supply; the devices are powered at SELV (Safety Extra Low Voltage) voltage, thus offering a much higher safety level than traditional commands. The configuration and commissioning is carried out by means of the ETS® software. The related application programs can be downloaded from the www.ekinex.com website.



Easy room thermostat FF series

WALL-MOUNT DEVICES

Description

The Ekinex® Easy room thermostat FF-series is a digital electronic thermostat with a user-friendly interface for the end user and system integrator. While using a single differentiated set point for heating and cooling with only one on/off operating mode, the unit allows the control of terminals with one or two stages (such as radiators, floor and ceiling radiant panels, etc.) and fan-coil units with 2 or 4 pipe hydraulic supply. The product is equipped with an LCD display with adjustable back-lighting, a sensor for room temperature measurement and two freely configurable inputs. The indicator LEDs can be chosen in blue/green or white/red colour combinations. The device has an integrated KNX bus communication module and is designed for installation in a flush-mounted wall box; it is powered by the KNX bus and requires no auxiliary power supply.

Main features

- LCD display with adjustable backlighting
- 2 keys for controlling the thermostat functions
- 4 freely programmable LEDs for each button
- 2 colour combinations available for LEDs (blue/green or white/red)
- Integrated temperature sensor
- 2 freely programmable inputs
- Plastic housing
- Bus line connection via KNX terminal
- Programming button and LED on front panel
- Recessed wall mounting on round or square box
- IP20 degree of protection (installed)
- Weight 85 g (with mounting bracket)

Technical data

- 30 Vdc power supply through KNX bus
- Current consumption from bus < 13 mA

Delivery

Delivery includes a terminal block for connection to the bus, a metal support for installation onto round or square mounting box (fixing holes 60 mm apart) and two pairs of fixing screws.

Accessories

The following accessories are available to be ordered separately:

- set of two square rockers with symbols for room thermostat
- square frame Form or Flank version

Dimensions [mm]

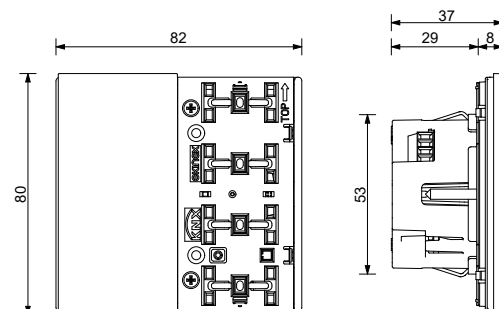

Order information

Code	LED colours	Mounting	Side profile
EK-ER2-TP	blue / green	with square frame	-
EK-ER2-TP-RW	red / white	Form or Flank version	-
EK-ER2-TP-BG-NF	blue / green		black
EK-ER2-TP-RW-NF	red / white	without frame ('NF version')	
EK-ER2-TP-BG-NFW	blue / green		white
EK-ER2-TP-RW-NFW	red / white		



Configuration and commissioning

By means of ETS5 software or later versions
Application program: **APEKER2TP##.knxprod**
(## = version, download from www.ekinex.com)



Documentation

For more information see the technical documentation, download from www.ekinex.com



Room thermostat FF series

WALL-MOUNT DEVICES

Description

The Ekinex® room temperature controller of FF series regulates independently the temperature of a room or a zone. In combination with one or more KNX actuators, the room temperature controller is able to control the heating and cooling emission of a series of terminal units for the thermal exchange (such as radiators, fan-coils, floor and ceiling radiant panels, etc.). The device is provided with a LCD-display with adjustable backlight, sensors for temperature and brightness measuring and two freely configurable inputs. The LEDs can be chosen in the colour combinations blue / green or white / red. The device integrates a KNX bus communication module and is intended for mounting onto a wall mounting box; it is powered by a SELV voltage directly from the KNX bus and does not require any auxiliary power supply.

Main features

- LCD-display with adjustable backlight
- 2 rockers for controlling thermostat functions
- 4 freely programmable LEDs for each channel
- 2 colour combination available for the LEDs (blue/green or red/white)
- Integrated temperature sensor
- 2 freely configurable inputs
- Plastic casing
- Connection to bus line with KNX terminal block
- Frontal programming pushbutton and LED
- Wall-mounting installation on round or square wall box
- IP20 protection degree (installed)
- Weight 85 g (with mounting support)

Technical data

- 30 Vdc power supply through KNX bus
- Current consumption from bus < 13 mA

Delivery

Delivery includes a terminal block for connection to the bus, a metal support for installation onto round or square mounting box (fixing holes 60 mm apart) and two pairs of fixing screws.

Accessories

The following accessories are available to be ordered separately:

- set of two square rockers with symbols for room thermostat
- square frame Form or Flank version

Dimensions [mm]

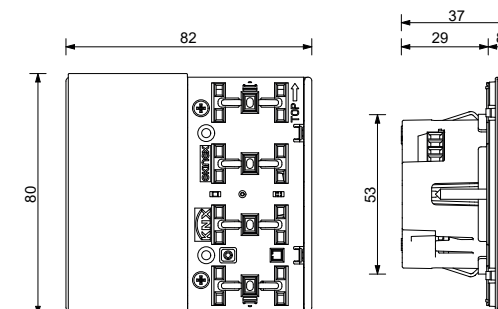

Order information

Code	LED colours	Mounting	Side profile
EK-EP2-TP	blue / green	with square frame	-
EK-EP2-TP-RW	red / white	Form or Flank version	-
EK-EP2-TP-BG-NF	blue / green		black
EK-EP2-TP-RW-NF	red / white	without frame ('NF version')	
EK-EP2-TP-BG-NFW	blue / green		white
EK-EP2-TP-RW-NFW	red / white		



Configuration and commissioning

By means of ETS5 software or later versions
Application program: **APEKEP2TP##.knxprod**
(## = version, download from www.ekinex.com)



Documentation

For more information see the technical documentation, download from www.ekinex.com





Room thermostat with relative humidity sensor FF series

WALL-MOUNT DEVICES

Description

The Ekinex® room temperature controller of FF series regulates independently the temperature of a room or a zone. In combination with one or more KNX actuators, the room temperature controller is able to control the heating and cooling emission of a series of terminal units for the thermal exchange (such as radiators, fan-coils, floor and ceiling radiant panels, etc.). The device is provided with a LCD-display with adjustable backlight, sensors for temperature, relative humidity and brightness measuring and two freely configurable inputs. The LEDs can be chosen in the colour combinations blue / green or white / red. The device integrates a KNX bus communication module and is intended for mounting onto a wall mounting box; it is powered by a SELV voltage directly from the KNX bus and does not require any auxiliary power supply.

Main features

- LCD-display with adjustable backlight
- 2 rockers for controlling thermostat functions
- 4 freely programmable LEDs for each channel
- 2 colour combination available for the LEDs (blue/green or red/white)
- Integrated temperature and relative humidity sensor
- 2 freely configurable inputs
- Plastic casing
- Connection to bus line with KNX terminal block
- Frontal programming pushbutton and LED
- Wall-mounting installation on round or square wall box
- IP20 protection degree (installed)
- Weight 85 g (with mounting support)

Technical data

- 30 Vdc power supply through KNX bus
- Current consumption from bus < 13 mA

Delivery

Delivery includes a terminal block for connection to the bus, a metal support for installation onto round or square mounting box (fixing holes 60 mm apart) and two pairs of fixing screws.

Accessories

- The following accessories are available to be ordered separately:
- set of two square rockers with symbols for room thermostat
 - square frame Form or Flank version

Dimensions [mm]

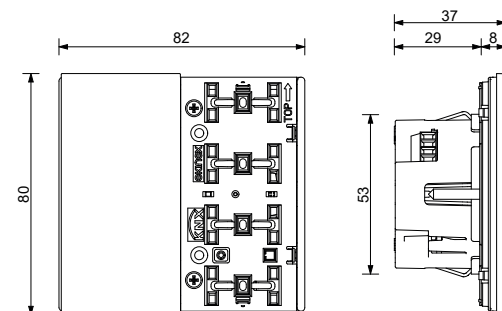

Order information

Code	LED colours	Mounting	Side profile
EK-EQ2-TP	blue / green	with square frame	-
EK-EQ2-TP-RW	red / white	Form or Flank version	-
EK-EQ2-TP-BG-NF	blue / green		black
EK-EQ2-TP-RW-NF	red / white	without frame (NF version)	
EK-EQ2-TP-BG-NFW	blue / green		white
EK-EQ2-TP-RW-NFW	red / white		



Configuration and commissioning

By means of ETS5 software or later versions
Application program: **APEKEQ2TP##.knxprod**
(## = version, download from www.ekinex.com)



Documentation

For more information see the technical documentation, download from www.ekinex.com





Touch&See

WALL-MOUNT DEVICES

Technology in a touch. When you want to touch the technology, see with your eyes your settings, know the weather or create the comfort you would like, trust Touch&See. The high resolution touch-display and the versatile and intuitive interface are thought to provide highest user comfort and uncompromising aesthetics. The transition from one function to the next one is via side-scrolling pages, from those you can access several sub-menus. You can also set the display brightness according to your own needs or it can be automatically adjusted according to the brightness.

Available colour solutions

	Form	Flank	Rockers
	Frames		
Plastic	•	•	•
Metal	•	•	•
Metal HT	-	-	•
Fenix NTM®	-	-	•

For more information see page 214

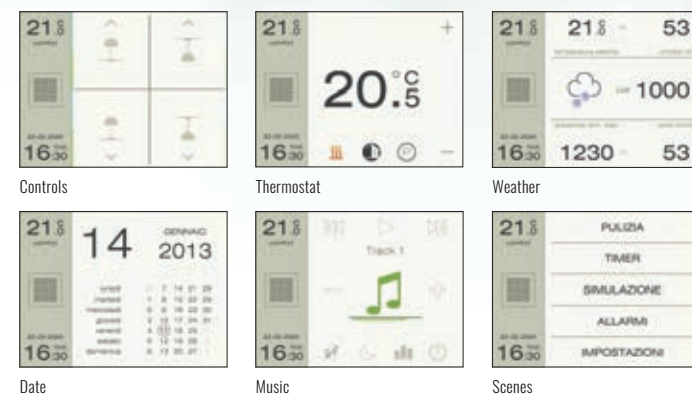

86 x 86 x 8 mm
Form



94 x 86 x 8 mm
Flank



80 x 80 x 8 mm
'NF - Deep - Surface



126 x 86 x 8 mm
Form



134 x 86 x 8 mm
Flank

Touch&See FF series

WALL-MOUNT DEVICES

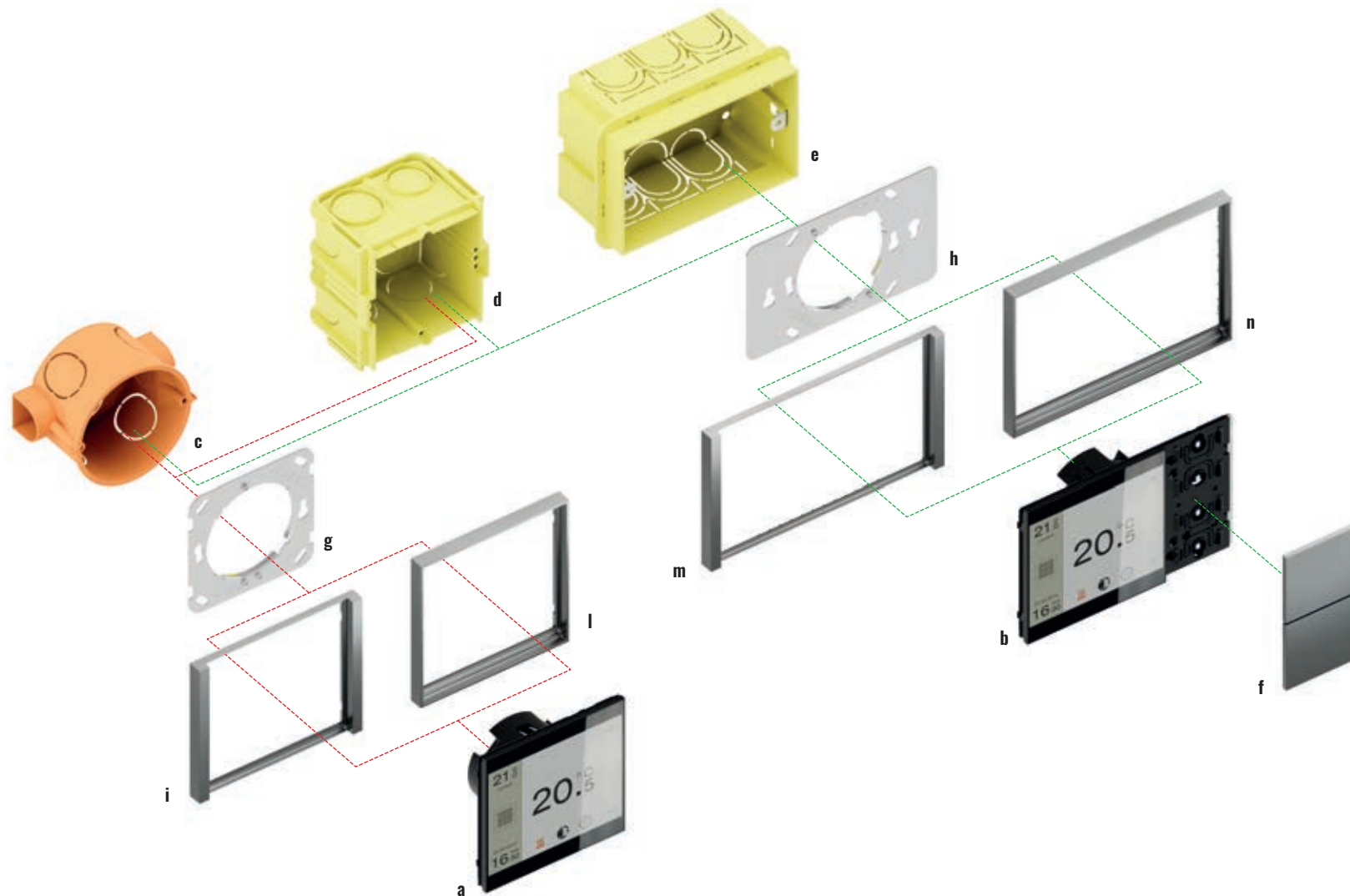

Control and display unit with two-channel pushbutton.
You will be amazed at all you can do.

The Ekinex® Touch&See display and control units allow to perform a great number of switching, control and display bus functions, utilizing the easiest and most compact devices, with their 3.5" touch-screen and their graphic pages having a clear meaning and immediate understanding.

The base is represented by the control and display unit (EK-EC2-TP-...) and the control and display unit with integrated 2-fold pushbutton (EK-EF2-TP-...); each one integrates a KNX communication module. The control and display unit is suitable for round or square wall mounting boxes with fixing holes 60 mm apart; the unit with the integrated 2-fold pushbutton is also suitable for rectangular wall mounting boxes provided with fixing holes 85 mm apart (3 seater according to the Italian installation standard).

Each Touch&See unit is delivered with a metal mounting support which, in case of necessity, can also be obtained separately; the terminal blocks complete the supply. The Touch&See unit needs to be finished with a frame; in the case of units with integrated 2-fold pushbuttons, it will also be necessary to provide it with two square rockers, available in plastic or aluminium and in several colours and finishings. The frames, either square or rectangular, are available in two alternative styles (Form and Flank) and share the same choice of materials, colours and finishing. The rockers can be personalized with symbols and text, in order to make their function immediately understandable. Each channel of the 2-fold pushbutton has integrated LEDs which can be programmed freely: as an example, as a status feedback or as an orientation light at night time. Two colour combinations are available for the LEDs: blue / green or red / white. The 'NF' version of the Touch&See EK-EC2-TP-... is mounted without frame and is provided with a side profile in white or black colour.

The Touch&See units have to be connected to the signal bus cable and to an auxiliary power supply; the devices are powered at SELV (Safety Extra Low Voltage) voltage, thus offering a much higher safety level than traditional commands. The configuration and commissioning is carried out by means of the ETS® software. The related application programs can be downloaded from the www.ekinex.com website.



Touch&See FF series

Description	Code
a) Touch&See display	EK-EC2-TP-...
b) Touch&See display with 2-fold pushbutton	EK-EF2-TP-...
c) Round flush-mounting box	not delivered by Ekinex®
d) Square flush-mounting box	not delivered by Ekinex®
e) Rectangular flush-mounting box (3 modules)	not delivered by Ekinex®
f) Square rockers	EK-TQQ-...

Description	Code
g) Metal mounting support	EK-SMQ-1
h) Metal mounting support	EK-SMR-1
i) Square frame Flank version	EK-FLQ-...
l) Square frame Form version	EK-FOQ-...
m) Rectangular frame Flank version	EK-FLR-...
n) Rectangular frame Form version	EK-FOR-...



Touch&See display

WALL-MOUNT DEVICES

Description

Ekinex® Touch&See is a KNX device for the switching, control and display of bus functions. By means of its touch-screen and its graphical user interface, it is possible to control KNX actuators in an easy and intuitive way, to display the information coming from the KNX actuators and sensors and to perform as a room thermostat for up to 8 independent zones, receiving the measured room temperature values from the bus. The device integrates a KNX bus communication module and is designed for wall mounting boxes: it is powered by a SELV voltage directly from the KNX bus and requires an auxiliary 30 Vdc power supply.

Main features

- 3,5" TFT back-lit touch display, 320 x 240 pixel resolution, 65,536 colours
- Seven main graphic pages
- Plastic casing
- Connection to bus line with KNX terminal block
- Connection to auxiliary power supply with yellow / white terminal block
- Programming pushbutton and LED on the rear
- Wall-mounting installation on round or square wall box
- IP20 protection degree (installed)
- Weight 110 g (with mounting support)

Technical data

- SELV power supply from KNX bus (communication)
- 30 Vdc auxiliary power supply (screen)

Delivery

Delivery includes a terminal block for connection to the bus, a terminal block for connection to the auxiliary power supply, a metal support for installation onto round or square mounting box (fixing holes 60 mm apart) and two pairs of fixing screws.

Accessories

The following accessories are available to be ordered separately:

- square frame Form or Flank version

Dimensions [mm]

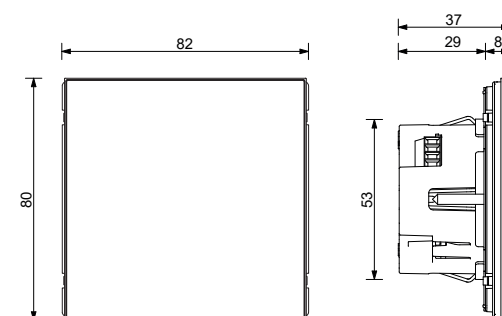

Configuration and commissioning

By means of ETS5 software or later versions
Application program: **APEKEC2TP##.knxprod**
(## = version, download from www.ekinex.com)



Documentation

For more information see the technical documentation, download from www.ekinex.com



Touch&See display with 2-fold pushbutton

WALL-MOUNT DEVICES

Description

Ekinex® Touch&See with 2-fold pushbutton is a KNX device for the switching, control and display of bus functions. By means of its touch-screen and the graphical user interface, it is possible to control KNX actuators in an easy and intuitive way, to display information coming from KNX actuators and sensors and to perform as a room thermostat for a maximum of 8 independent zones. One temperature value can be measured from the integrated sensor, while the other values can be received from the bus. The integrated 2-fold pushbutton allows the on/off command of loads, the dimming of lighting devices, the control of motor drives for shutters or the execution of any other programmable command and control function. The LEDs can be chosen in the colour combinations blue / green or white / red. The device integrates a KNX bus communication module and is designed or mounting onto a wall-mounting box: it is powered by SELV voltage directly from the KNX bus and requires an auxiliary 30 Vdc power supply.

Main features

- 3,5" TFT back-lit touch display, 320 x 240 pixel resolution, 65,536 colours
- Seven main graphic pages
- Integrated temperature sensor
- 2-fold pushbutton (possibility to configure up to 4 independent functions)
- 4 freely programmable LEDs for each channel
- 2 colour combination available for the LEDs (blue/green or red/white)
- Plastic casing
- Connection to bus line with KNX terminal block
- Connection to auxiliary power supply with yellow / white terminal block
- Programming pushbutton and LED on the rear
- Wall-mounting installation on round, square or rectangular wall box
- IP20 protection degree (installed)
- Weight 130 g (with mounting support)

Technical data

- SELV power supply from KNX bus (communication)
- 30 Vdc auxiliary power supply (screen)

Delivery

Delivery includes a terminal block for connection to the bus, a terminal block for connection to the auxiliary power supply, a metal support for installation onto round or square mounting box (fixing holes 60 mm apart) or rectangular mounting box (fixing holes 83,5 mm apart) and two pairs of fixing screws.

Accessories

The following accessories are available to be ordered separately:

- square rockers
- rectangular frame Form or Flank version

Dimensions [mm]

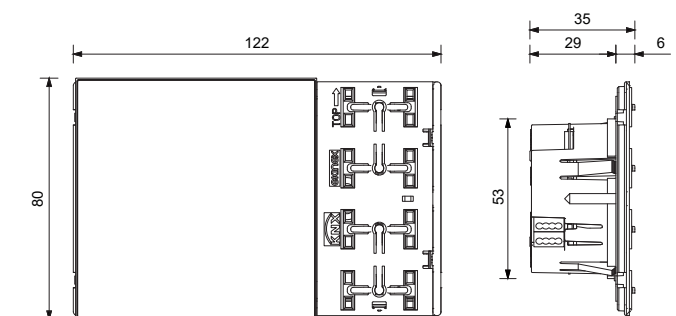

Configuration and commissioning

By means of ETS5 software or later versions
Application program: **APEKEF2TP##.knxprod**
(## = version, download from www.ekinex.com)



Documentation

For more information see the technical documentation, download from www.ekinex.com



A dark, minimalist wall-mounted device with a glowing red light strip. The device is composed of several rectangular panels with recessed edges, creating a layered, architectural look. The lighting is dramatic, highlighting the textures and lines of the design.

71 SERIES
WALL-MOUNT DEVICES

Form	86
Flank	88
*NF	90
Deep	92
Surface	94



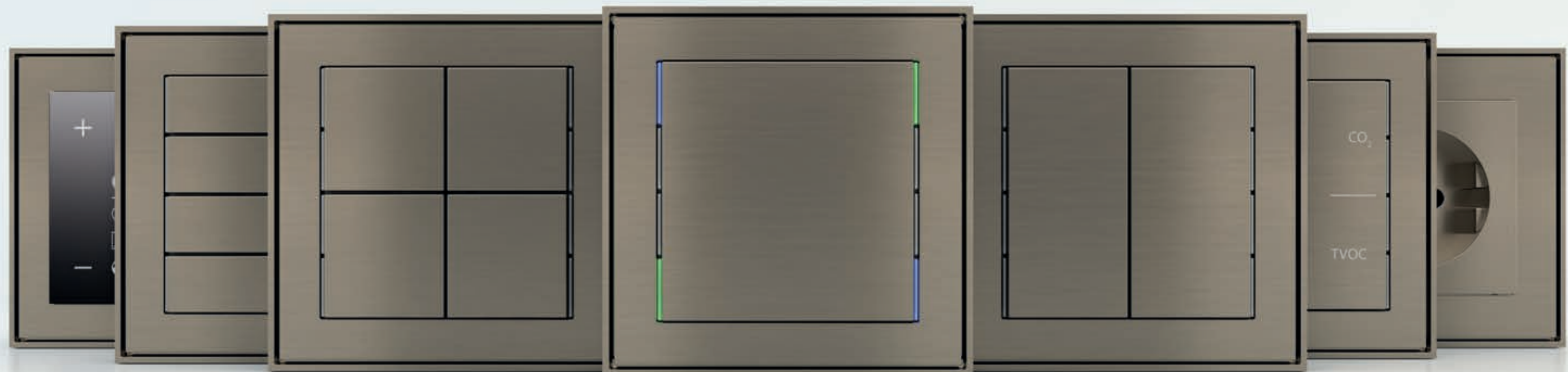

71 Form

WALL-MOUNT DEVICES

Elegant and refined. The compactness that adapts to your style. With an ultra-slim frame, the Form version of the 71 series features devices with integrated LEDs with adjustable light intensity, power sockets and keystone modules. The materials used are plastic, metal, Metal HT, the nanotechnological Fenix NTM® and the different finishes can be freely combined to each other.

Available colour solutions

	Form	Flank	'NF	Deep	Surface	Rockers
	Frames		Plates			
Plastic	•	•	•	•	-	•
Metal	•	•	•	•	•	•
Metal HT	-	-	-	•	•	•
Fenix NTM®	-	-	•	•	•	•

For more information see page 214

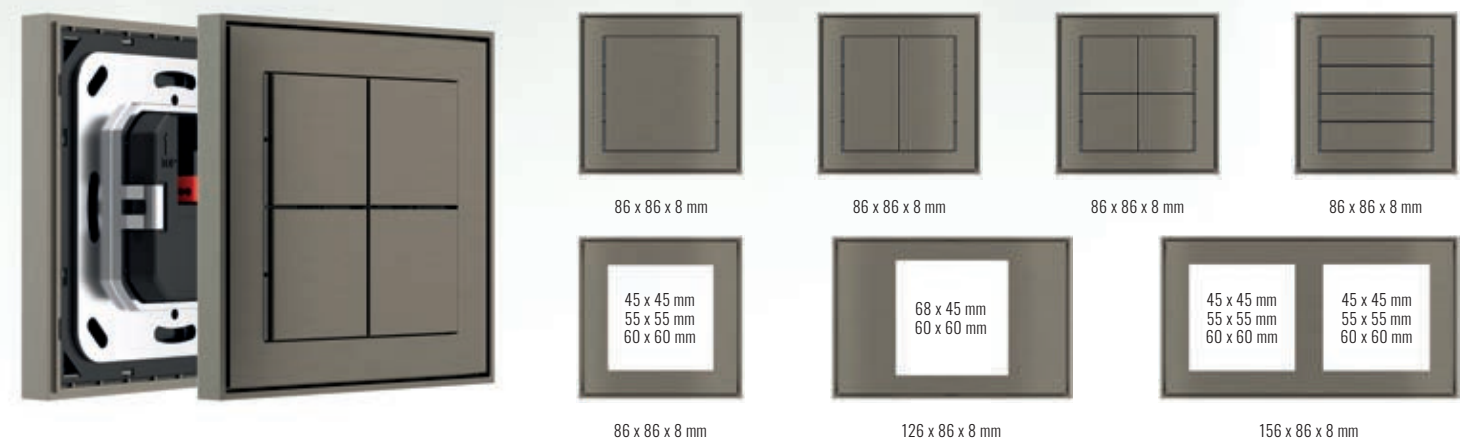



71 Flank

WALL-MOUNT DEVICES

Harmony and essentiality. The rigorous simplicity of detail. The Flank version of the 71 series features a wide range of devices with integrated LEDs with adjustable light intensity, power sockets and keystone modules with simple shapes and distinctive side edges. The materials used are plastic, metal, Metal HT, the nanotechnological Fenix NTM® and the different finishes can be freely combined to each other.

Available colour solutions

	Form	Flank	'NF	Deep	Surface	Rockers
	Frames		Plates			
Plastic	•	•	•	•	-	•
Metal	•	•	•	•	•	•
Metal HT	-	-	-	•	•	•
Fenix NTM®	-	-	•	•	•	•

For more information see page 214

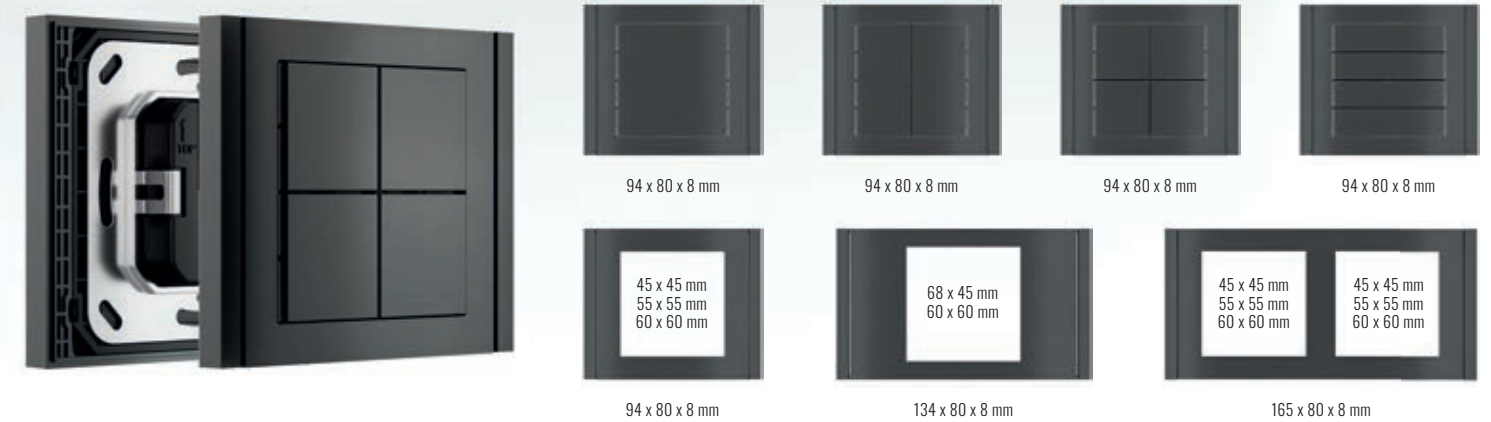

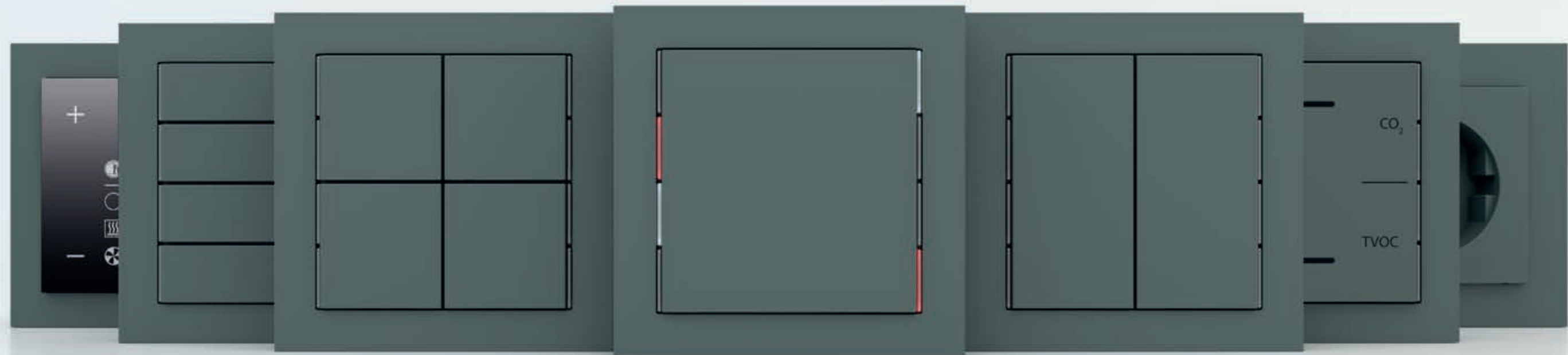

71 'NF'
WALL-MOUNT DEVICES

Simple and rational. Frameless, the 'NF' version of the 71 series features devices with integrated LEDs with adjustable light intensity, power sockets and keystone modules. The materials used are plastic, metal, Metal HT, the nanotechnological Fenix NTM® and the different finishes can be freely combined to each other.

Available colour solutions

	Form	Flank	'NF'	Deep	Surface	Rockers
	Frames					
Plastic	•	•	•	•	-	•
Metal	•	•	•	•	•	•
Metal HT	-	-	-	•	•	•
Fenix NTM®	-	-	•	•	•	•

For more information see page 214

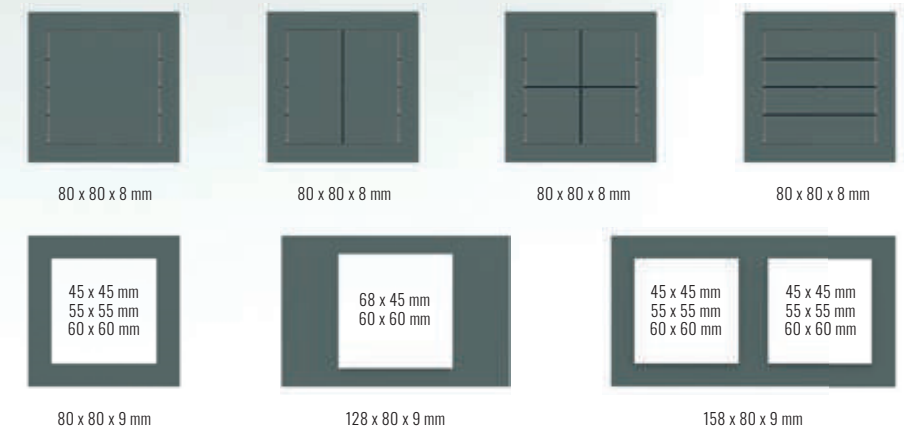

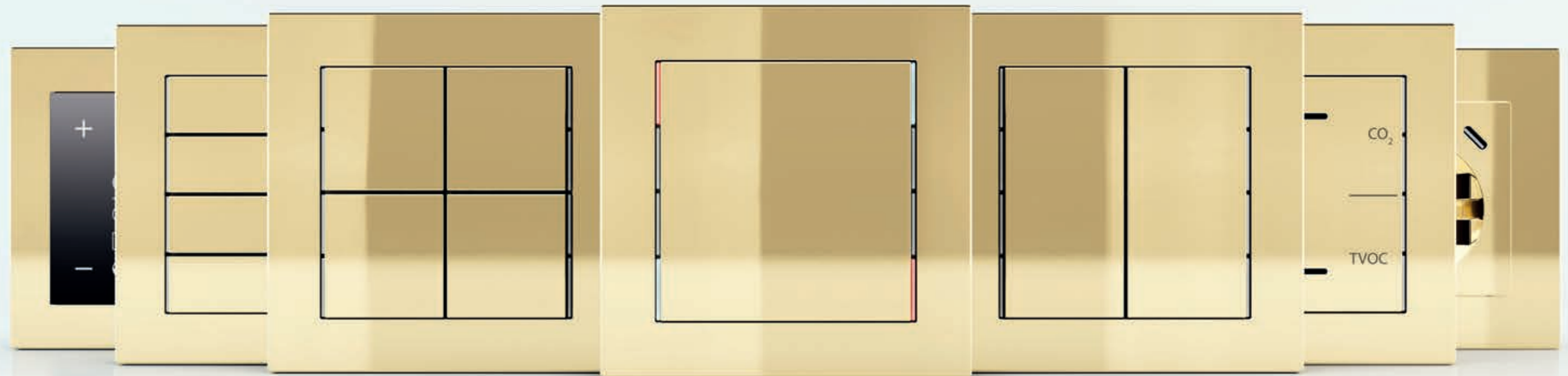

71 Deep

WALL-MOUNT DEVICES

Slim and elegant. The Deep version of the 71 series features devices with integrated LEDs with adjustable light intensity, power sockets and keystone modules. The materials used are plastic, metal, Metal HT, the nanotechnological Fenix NTM®. The different finishes can be freely combined with each other, to match even the most eclectic and design-intensive spaces.

Available colour solutions

	Form	Flank	'NF	Deep	Surface	Rockers
	Frames		Plates			
Plastic	•	•	•	•	-	•
Metal	•	•	•	•	•	•
Metal HT	-	-	-	•	•	•
Fenix NTM®	-	-	•	•	•	•

For more information see page 214

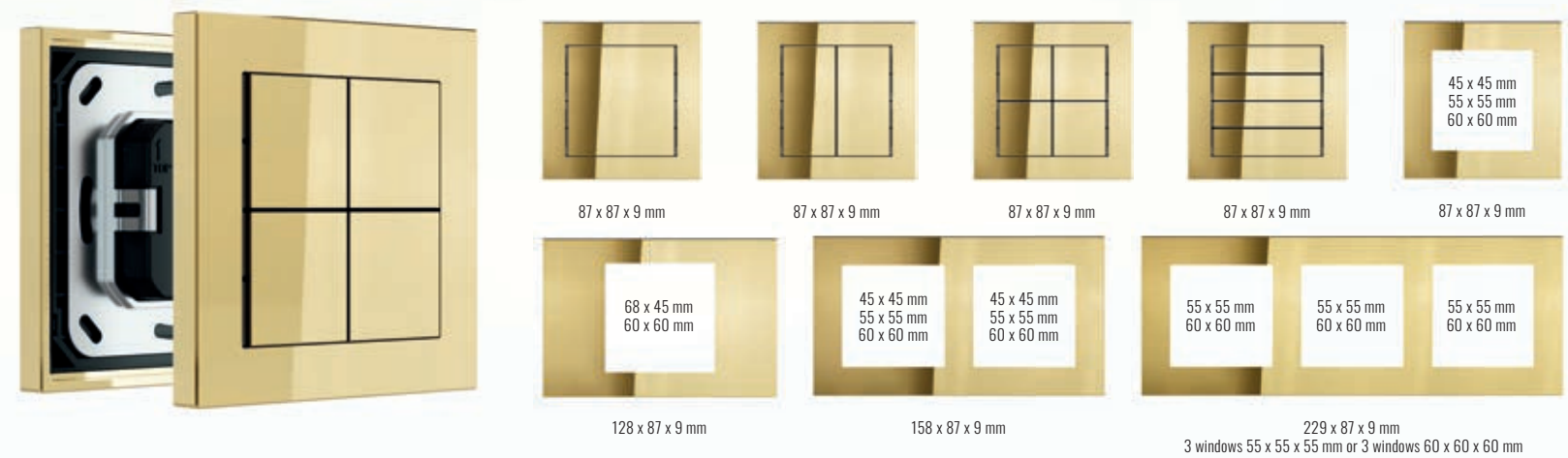

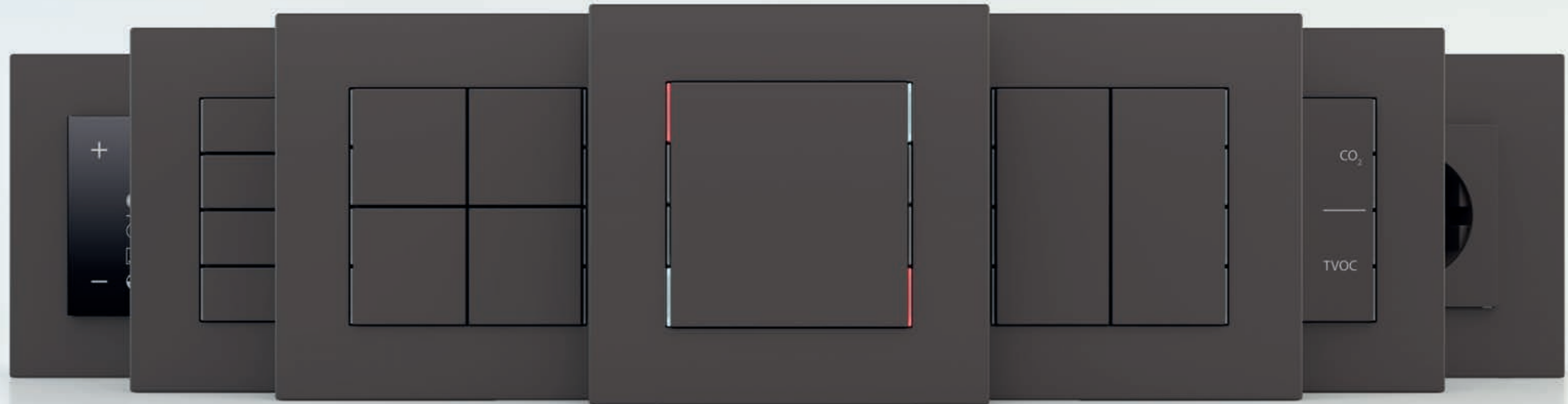

71 Surface

WALL-MOUNT DEVICES

Essentiality and functionality for the contemporary home. Designed to create a continuum with the wall, the Surface version of the 71 series integrates with the background until it almost becomes part of it. It features devices with integrated LEDs with adjustable light intensity, power sockets and keystone modules. The different available combinations make it particularly versatile and successful in the most different situations. The materials used are metal, Metal HT and the nanotechnological Fenix NTM®.

Available colour solutions

	Form	Flank	*NF	Deep	Surface	Rockers
	Frames		Plates			
Plastic	•	•	•	•	-	•
Metal	•	•	•	•	•	•
Metal HT	-	-	-	•	•	•
Fenix NTM®	-	-	•	•	•	•

For more information see page 214

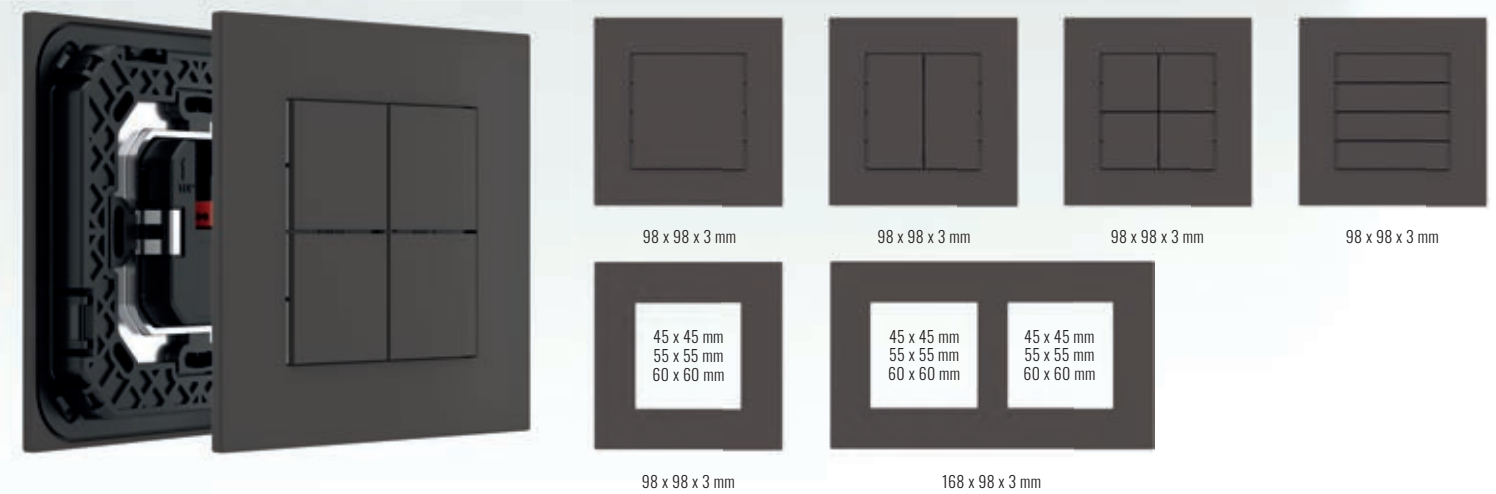

Pushbuttons 71 series

WALL-MOUNT DEVICES

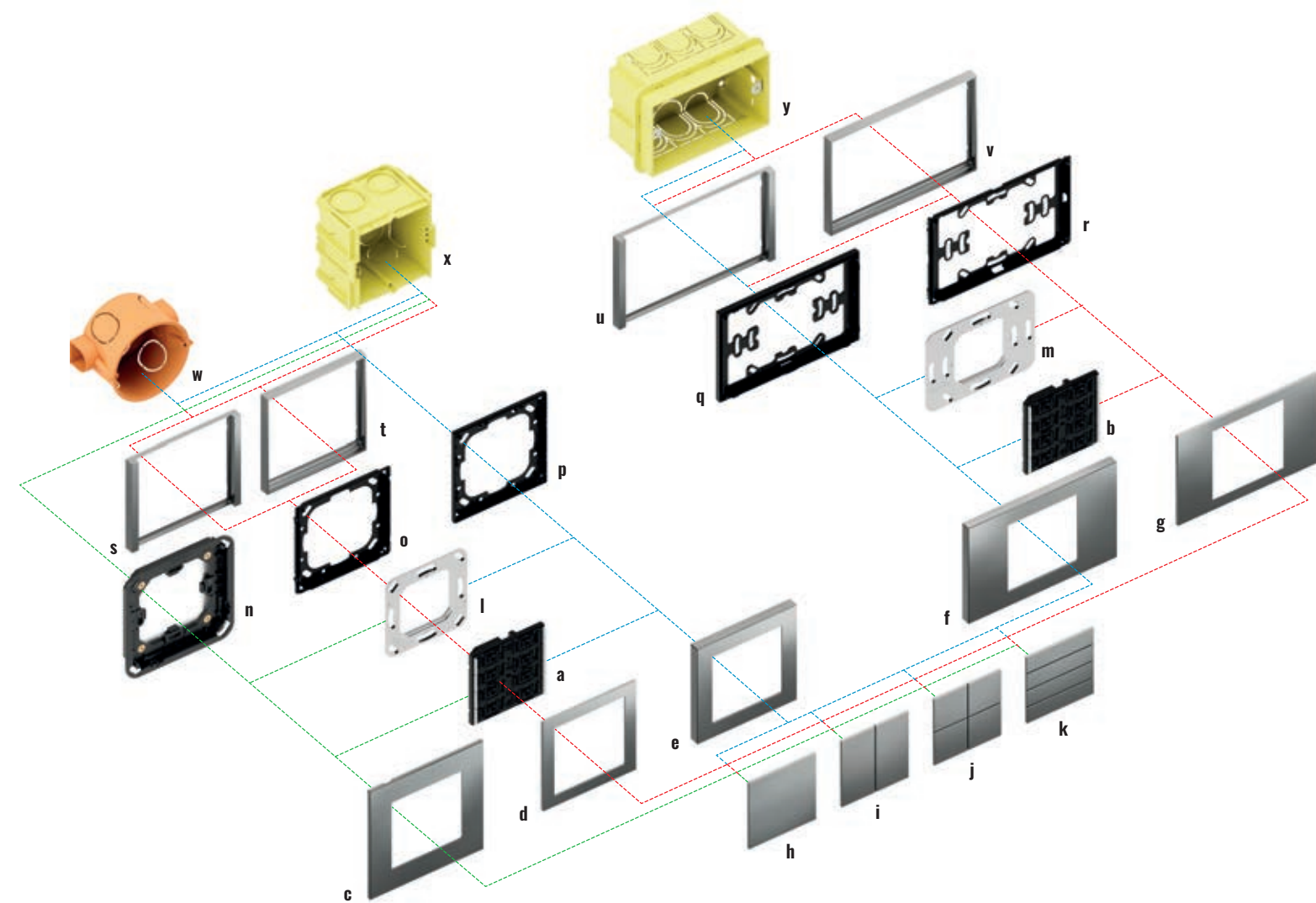

71 series: infinite number of combinations for a unique style. The series of 71 buttons are available in square or rectangular version with single, double or triple window (Deep version only).

The Ekinex® pushbuttons of 71 series range and related accessories offer the possibility to realize several variations that will satisfy the most diverse needs. The base is represented by the device which is fitted with a KNX communication module. The pushbutton is suitable for mounting into a flush mounting box, either round or square, provided with fixing holes 60 mm apart and for mounting into a rectangular wall mounting box 3 seater according to the Italian installation standard provided with fixing holes 83,5 mm apart. Each pushbutton is delivered with a terminal block and two pairs of fixing screws.

The pushbuttons must be finished off with its relative metal support, a plastic adapter, an operation surface (rockers), a plate with 60 x 60 mm window and a frame. The rockers are available in square and rectangular shapes of different modularities, in plastic material, aluminium or Fenix NTM® and in several colours. Version EK-E13-TP-.. has integrated LEDs which can be programmed freely: as an example, as a status feedback or as an orientation light at night time. Two colour combinations are available for the LEDs: blue / green or red / white. The same version also offers a room thermostat function, thanks to the integrated temperature sensor. The frames, square and rectangular, are available in two stylish alternatives (Form and Flank) and are available in plastic material or aluminium and in several colours and finishings. The 'NF' version of the pushbutton is mounted without frame and is provided with a side profile in white or black colour.

The pushbuttons simply get connected to the unique signal bus cable and do not require auxiliary power supply; the devices are supplied at SELV (Safety Extra Low Voltage) voltage, thus offering a much higher safety level than traditional commands. The configuration and commissioning is carried out by means of the ETS® software. The related application programs can be downloaded from the www.ekinex.com website.

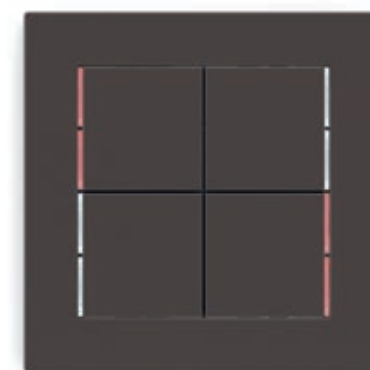

Pushbuttons 71 series

Description	Code
a) b) Pushbutton 71 series	EK-E13-TP-... o EK-E23-TP
c) Square plate Surface version*	EK-SQS-...
d) Square plate*	EK-PQS-...
e) Square plate Deep version*	EK-DQP-...
f) Rectangular plate Deep version*	EK-DRS-...
g) Rectangular plate*	EK-PRS-...
h) Square rocker (1)	EK-T1Q-...
i) Rectangular vertical rockers (2)	EK-T2R-...
j) Square rockers (4)	EK-T4Q-...
k) Rectangular horizontal rockers (4)	EK-T4R-...
l) Metal mounting support	EK-SMQ-71-1
m) Metal mounting support with adapter	EK-SMR-71-1

Description	Code
n) Adapter for square Surface plate	EK-TAS-Q-W or EK-TAS-Q-N
o) Adapter for square plate Form or Flank frames	EK-TAQE-1
p) Adapter for square plate 'NF' and Deep version	EK-TAQE-1-NF
q) Adapter for rectangular plate 'NF' and Deep version	EK-TAR-1-NF
r) Adapter for rectangular plate Form or Flank frames	EK-TAR-1
s) Square frame Flank version	EK-FLQ-...
t) Square frame Form version	EK-FOQ-...
u) Rectangular frame Flank version	EK-FLR-...
v) Rectangular frame Form version	EK-FOR-...
w) Round flush-mounting box	not delivered by Ekinex®
x) Square flush-mounting box	not delivered by Ekinex®
y) Rectangular flush-mounting box (3 modules)	not delivered by Ekinex®

*) 60 x 60 mm window

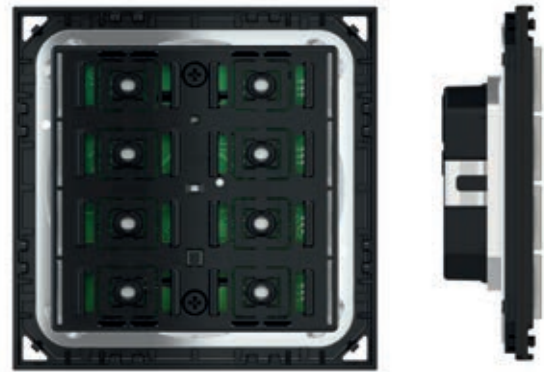

4-fold basic pushbutton 71 series

WALL-MOUNT DEVICES

Description

The 4-fold pushbutton of Ekinex® 71 series commands loads on/off switching, controls the dimming of lighting devices, controls motor drives for shutters or executes any other programmable command and control function. The device integrates a KNX bus communication module and is intended for mounting onto a wall mounting box; it is supplied by a SELV voltage directly from the KNX bus and does not require any auxiliary power supply.

Main features

- 4-fold (possibility to configure up to 8 independent functions)
- Plastic casing
- Connection to bus line with KNX terminal block
- Frontal programming pushbutton and LED
- Wall-mounting installation on round or square wall box
- IP20 protection degree (installed)
- Weight 70 g (with mounting support)

Technical data

- 30 Vdc power supply by KNX bus
- Current consumption from bus < 15 mA

Delivery

Delivery includes a terminal block for connection to the bus, two pairs of fixing screws.

Accessories

The following accessories are available to be ordered separately:

- set of 1 square rocker, 2 vertical rectangular rockers, 4 square rockers or 4 horizontal rectangular rockers
- square and double frame Form or Flank version
- square, double and triple plate with 60 x 60 mm window
- a plastic adapter
- metal support for installation onto round or square mounting box (fixing holes 60 mm apart)

Dimensions [mm]

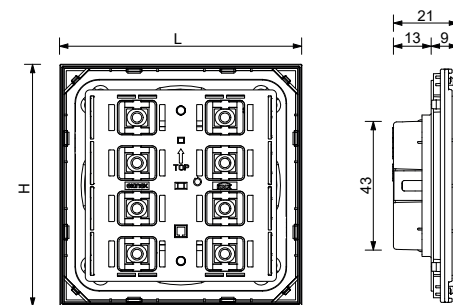

Mounting with frame: 81 x 77 (L x H)
Mounting without frame (*NF): 80 x 80 (L x H)

Order information

Code	Mounting
EK-E23-TP	with square and double frame Form or Flank version, without frame (*NF version)



Configuration and commissioning

By means of ETS5 software or later versions
Application program: **APEKE23TP##.knxprod**
(## = version, downloadable from www.ekinex.com)



Documentation

For more information see the technical documentation, download from www.ekinex.com



4-fold basic pushbutton and room thermostat for rectangular wall-box 71 series

WALL-MOUNT DEVICES

Description

The 4-fold pushbutton of Ekinex® 71 series commands loads on/off switching, controls the dimming of lighting devices, controls motor drives for shutters or executes any other programmable command and control function. The device integrates a KNX bus communication module and is intended for mounting onto a wall mounting box; it is supplied by a SELV voltage directly from the KNX bus and does not require any auxiliary power supply.

Main features

- 4-fold (possibility to configure up to 8 independent functions)
- Plastic casing
- Connection to bus line with KNX terminal block
- Frontal programming pushbutton and LED
- Wall-mounting installation on round, square or rectangular wall box
- IP20 protection degree (installed)
- Weight 100 g (with mounting support)

Technical data

- 30 Vdc power supply by KNX bus
- Current consumption from bus < 15 mA

Delivery

Delivery includes a terminal block for connection to the bus, two pairs of fixing screws.

Accessories

The following accessories are available to be ordered separately:

- set of 1 square rocker, 2 vertical rectangular rockers, 4 square rockers or 4 horizontal rectangular rockers
- rectangular frame Form or Flank version
- rectangular plate with 60 x 60 mm window
- a plastic adapter
- a metal support for installation onto round or square (fixing holes 60 mm apart) or rectangular (fixing holes 83,5 mm apart) mounting box

Dimensions [mm]

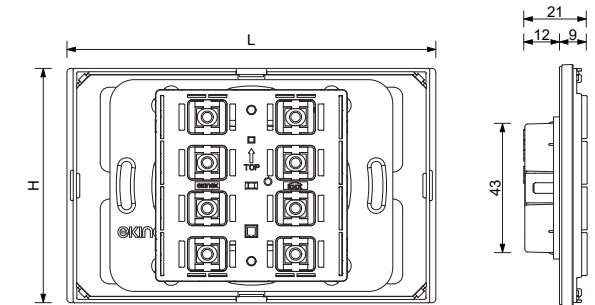

Mounting with frame: 122 x 77 (L x H)
Mounting without frame (*NF): 120 x 80 (L x H)

Order information

Code	Mounting
EK-E23-TP	with square and double frame Form or Flank version, without frame (*NF version)



Configuration and commissioning

By means of ETS5 software or later versions
Application program: **APEKE23TP##.knxprod**
(## = version, downloadable from www.ekinex.com)



Documentation

For more information see the technical documentation, download from www.ekinex.com



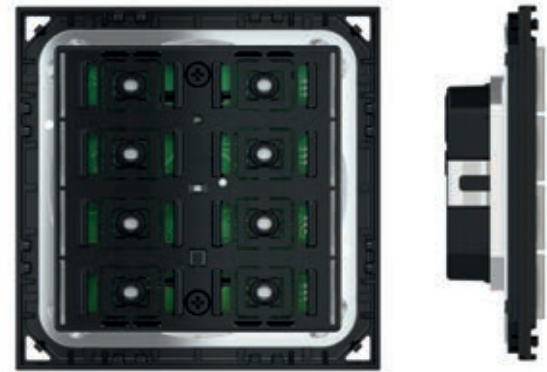

4-fold pushbutton and room thermostat 71 series

WALL-MOUNT DEVICES

Description

The 4-fold pushbutton of Ekinex® 71 series commands loads on/off switching, controls the dimming of lighting devices, controls motor drives for shutters or executes any other programmable command and control function. Thanks to the integrated temperature sensor, the pushbutton can work as a thermostat for a room or a zone. The LED can be chosen in the colour combinations blue / green or white / red. The device integrates a KNX bus communication module and is intended for mounting onto a wall mounting box; it is powered by a SELV voltage directly from the KNX bus and does not require any auxiliary power supply.

Main features

- 4-fold (possibility to configure up to 8 independent functions)
- 4 freely programmable LED for each channel
- 2 colour combination available for the LED (blue / green or red / white)
- Room thermostat function
- Integrated temperature sensor
- Plastic casing
- Connection to bus line with KNX terminal block
- Frontal programming pushbutton and LED
- Wall-mounting installation on round or square wall box
- IP20 protection degree (installed)
- Weight 70 g (with mounting support)

Technical data

- 30 Vdc power supply by KNX bus
- Current consumption from bus < 15 mA

Delivery

Delivery includes a terminal block for connection to the bus, two pairs of fixing screws.

Accessories

The following accessories are available to be ordered separately:

- set of 1 square rocker, 2 vertical rectangular rockers, 4 square rockers or 4 horizontal rectangular rockers
- square and double frame Form or Flank version
- square, double and triple plate with 60 x 60 mm window
- a plastic adapter
- metal support for installation onto round or square mounting box (fixing holes 60 mm apart)

Dimensions [mm]

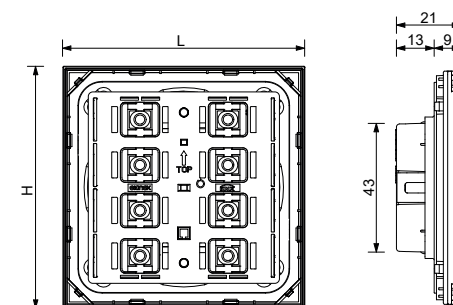

Mounting with frame: 81 x 77 (L x H)
Mounting without frame (*NF): 80 x 80 (L x H)



Configuration and commissioning

By means of ETS5 software or later versions
Application program: **APEKE13TP##.knxprod**
(## = version, download from www.ekinex.com)



Documentation

For more information see the technical documentation, download from www.ekinex.com



4-fold pushbutton and room thermostat for rectangular wall-box 71 series

WALL-MOUNT DEVICES

Description

The 4-fold pushbutton of Ekinex® 71 series commands loads on/off switching, controls the dimming of lighting devices, controls motor drives for shutters or executes any other programmable command and control function. Thanks to the integrated temperature sensor, the pushbutton can work as a thermostat for a room or a zone. The LED can be chosen in the colour combinations blue / green or white / red. The device integrates a KNX bus communication module and is intended for mounting onto a wall mounting box; it is powered by a SELV voltage directly from the KNX bus and does not require any auxiliary power supply.

Main features

- 4-fold (possibility to configure up to 8 independent functions)
- 4 freely programmable LED for each channel
- 2 colour combination available for the LED (blue / green or red / white)
- Room thermostat function
- Integrated temperature sensor
- Plastic casing
- Connection to bus line with KNX terminal block
- Frontal programming pushbutton and LED
- Wall-mounting installation on round, square or rectangular wall box
- IP20 protection degree (installed)
- Weight 100 g (with mounting support)

Technical data

- 30 Vdc power supply by KNX bus
- Current consumption from bus < 15 mA

Delivery

Delivery includes a terminal block for connection to the bus, two pairs of fixing screws.

Accessories

The following accessories are available to be ordered separately:

- set of 1 square rocker, 2 vertical rectangular rockers, 4 square rockers or 4 horizontal rectangular rockers
- rectangular frame Form or Flank version
- rectangular plate with 60 x 60 mm window
- a plastic adapter
- a metal support for installation onto round or square (fixing holes 60 mm apart) or rectangular (fixing holes 83,5 mm apart) mounting box

Dimensions [mm]

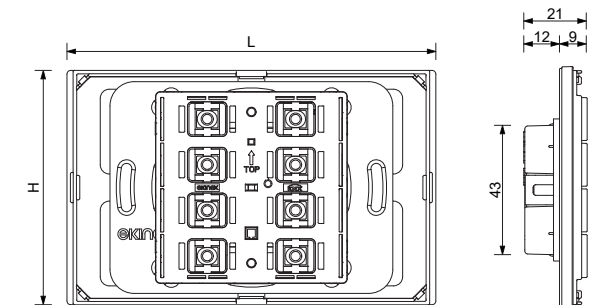

Mounting with frame: 122 x 77 (L x H)
Mounting without frame (*NF): 120 x 80 (L x H)



Configuration and commissioning

By means of ETS5 software or later versions
Application program: **APEKE13TP##.knxprod**
(## = version, download from www.ekinex.com)



Documentation

For more information see the technical documentation, download from www.ekinex.com





Room thermostats

WALL-MOUNT DEVICES

Create a positive atmosphere. The different operating modes of the 71 series room temperature control allow you to adapt the control to your needs, save energy and ensure your comfort. The numerous integrated functions ensure a comfortable environment in all seasons. The 71 room temperature control will make you want to come back home.

Available colour solutions

	Form	Flank	'NF	Deep	Surface
	Frames		Plates		
Plastic	•	•	•	•	-
Metal	•	•	•	•	•
Metal HT	-	-	-	•	•
Fenix NTM®	-	-	•	•	•

For more information see page 214



86 x 86 x 8 mm
Form



94 x 86 x 8 mm
Flank



80 x 80 x 8 mm
'NF



86 x 86 x 9 mm
Deep



98 x 98 x 3 mm
Surface

Room thermostats 71 series

WALL-MOUNT DEVICES

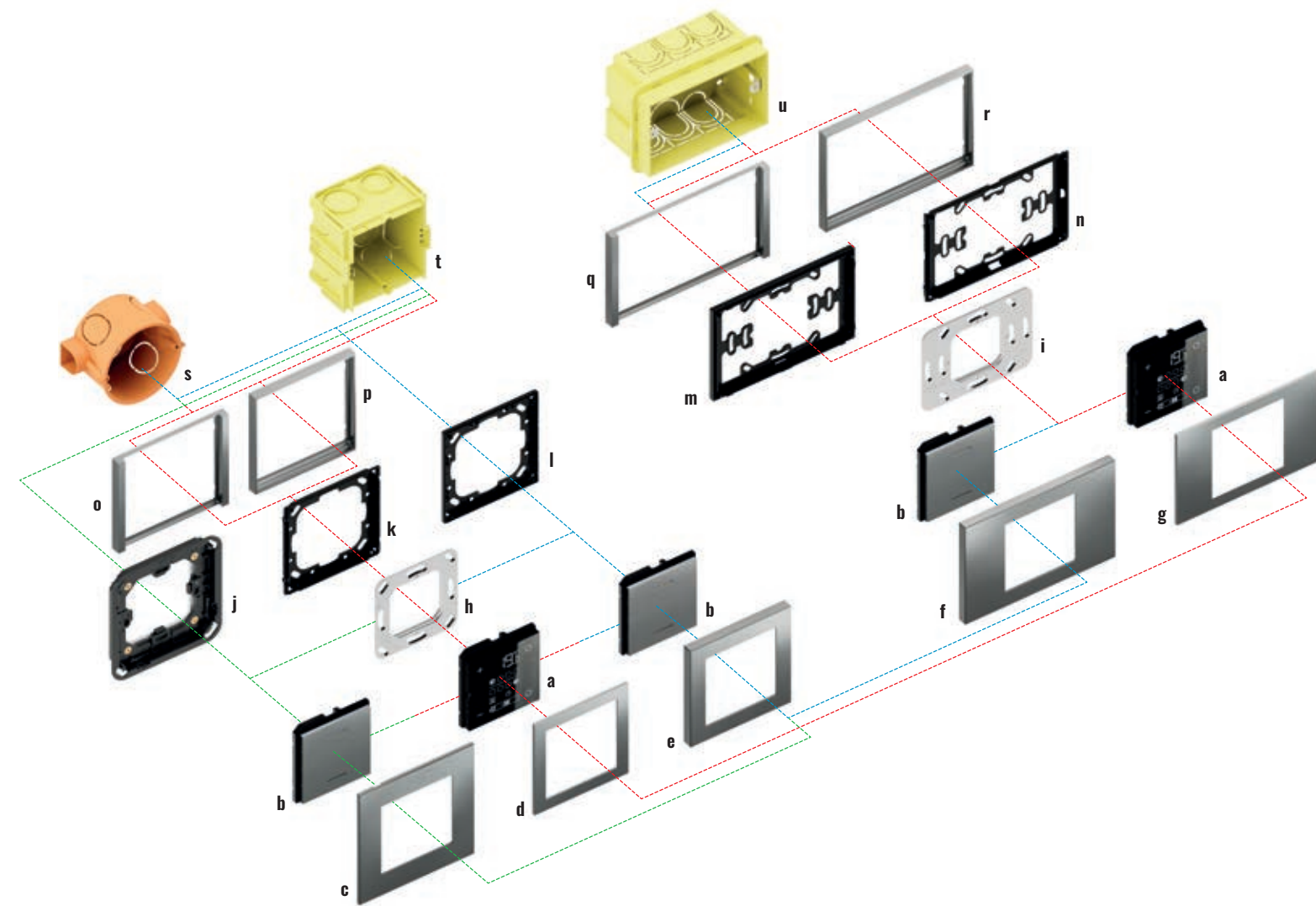

Many different combinations, possibilities installation horizontally or vertically, 71 room temperature control meets all requirements. Yours too...

The Ekinex® thermostats of 71 series range and related accessories offer the possibility to realize several variations that will satisfy the most diverse needs. The base is represented by the device which is fitted with a KNX communication module. The thermostat is suitable for mounting into a flush mounting box, either round or square, provided with fixing holes 60 mm apart or for mounting into a rectangular wall mounting box 3 modules according to the Italian installation standard provided with fixing holes 83,5 mm apart. Each thermostat is delivered with a terminal block and two pairs of fixing screws.

Depending on the version, the thermostat must be completed with its relative metal support, a plastic adapter, a square or rectangular plate with 60 x 60 mm window and a square or rectangular frame. The frames are available in two stylish alternatives (Form and Flank). Plates and frames are in plastic material, aluminium or Fenix NTM®, in several colour and finishing variations. The 'NF' versions of the thermostats are mounted without frame and are provided with a side profile in white or black colour.

The thermostats simply get connected to the unique signal bus cable and do not require auxiliary power supply; the devices are powered at SELV (Safety Extra Low Voltage) voltage, thus offering a much higher safety level than traditional commands. The configuration and commissioning is carried out by means of the ETS® software. The related application programs can be downloaded from the www.ekinex.com website.



Room thermostats and Multisensors 71 series

Description	Code
a) Thermostat 71 series	EK-E73-TP
b) Multisensor 71 series	EK-ET3-TP or EK-ES3-TP
c) Square plate Surface version*	EK-SQS-...
d) Square plate*	EK-PQS-...
e) Square plate Deep version*	EK-DQP-...
f) Rectangular plate Deep version*	EK-DRS-...
g) Rectangular plate*	EK-PRS-...
h) Metal mounting support	EK-SMQ-71-1
i) Metal mounting support with adapter	EK-SMR-71-1
j) Adapter for square Surface plate	EK-TAS-Q-W or EK-TAS-Q-N
k) Adapter for square plate Form or Flank frames	EK-TAQE-1

Description	Code
l) Adapter for square plate 'NF' and Deep version	EK-TAQE-1-NF
m) Adapter for rectangular plate 'NF' and Deep version	EK-TAR-1-NF
n) Adapter for rectangular plate Form or Flank frames	EK-TAR-1
o) Square frame Flank version	EK-FLQ-...
p) Square frame Form version	EK-FOQ-...
q) Rectangular frame Flank version	EK-FLR-...
r) Rectangular frame Form version	EK-FOR-...
s) Round flush-mounting box	not delivered by Ekinex®
t) Square flush-mounting box	not delivered by Ekinex®
u) Rectangular flush-mounting box (3 modules)	not delivered by Ekinex®

*) 60 x 60 mm window



Room thermostat 71 series

WALL-MOUNT DEVICES

Description

The Ekinex® room temperature controller of 71 series regulates independently the temperature of a room or a zone. In combination with one or more KNX actuators, the room temperature controller is able to control the heating and cooling emission of a series of terminal units for the thermal exchange (such as radiators, fan-coils, floor and ceiling radiant panels, etc.). The device is provided with a LCD-Display with adjustable backlight, and a sensor for temperature measuring. The device integrates a KNX bus communication module and is intended for mounting onto a wall mounting box; it is powered by a SELV voltage directly from the KNX bus and does not require any auxiliary power supply.

Main features

- LCD-Display with adjustable backlight
- 4 capacitive pushbuttons for controlling of the thermostat functions
- Integrated temperature sensor
- Plastic casing
- Connection to bus line with KNX terminal block
- Frontal programming pushbutton and LED
- Wall-mounting installation on round or square wall box
- IP20 protection degree (installed)
- Weight 90 g (with mounting support)

Technical data

- 30 Vdc power supply by KNX bus
- Current consumption from bus < 13 mA

Delivery

Delivery includes a terminal block for connection to the bus, two pairs of fixing screws.

Accessories

The following accessories are available to be ordered separately:

- square and double frame Form or Flank version
- square, double and triple plate with 60 x 60 mm window
- a plastic adapter
- a metal support for installation onto round or square mounting box (fixing holes 60 mm apart)

Dimensions [mm]

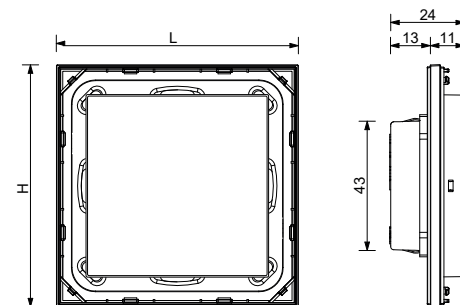

Mounting with frame: 81 x 77 (L x H)
Mounting without frame (NF): 80 x 80 (L x H)



Configuration and commissioning

By means of ETS5 software or later versions
Application program: **APEKE73TP##.knxprod**
(## = version, download from www.ekinex.com)



Documentation

For more information see the technical documentation, download from www.ekinex.com



Room thermostat for rectangular wall-box 71 series

WALL-MOUNT DEVICES

Description

The Ekinex® room temperature controller of 71 series regulates independently the temperature of a room or a zone. In combination with one or more KNX actuators, the room temperature controller is able to control the heating and cooling emission of a series of terminal units for the thermal exchange (such as radiators, fan-coils, floor and ceiling radiant panels, etc.). The device is provided with a LCD-Display with adjustable backlight, and a sensor for temperature measuring. The device integrates a KNX bus communication module and is intended for mounting onto a wall mounting box; it is powered by a SELV voltage directly from the KNX bus and does not require any auxiliary power supply.

Main features

- LCD-Display with adjustable backlight
- 4 capacitive pushbuttons for controlling of thermostat functions
- Integrated temperature sensor
- Plastic casing
- Connection to bus line with KNX terminal block
- Frontal programming pushbutton and LED
- Wall-mounting installation on round, square or rectangular wall box
- IP20 protection degree (installed)
- Weight 120 g (with mounting support)

Technical data

- 30 Vdc power supply by KNX bus
- Current consumption from bus < 13 mA

Delivery

Delivery includes a terminal block for connection to the bus, two pairs of fixing screws.

Accessories

The following accessories are available to be ordered separately:

- rectangular frame Form or Flank version
- rectangular plate with 60 x 60 mm window
- a plastic adapter
- a metal support for installation onto round or square (fixing holes 60 mm apart) or rectangular (fixing holes 83,5 mm apart) mounting box

Dimensions [mm]

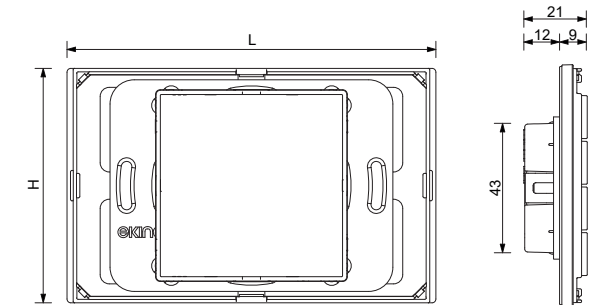

Mounting with frame: 122 x 77 (L x H)
Mounting without frame (NF): 120 x 80 (L x H)



Configuration and commissioning

By means of ETS5 software or later versions
Application program: **APEKE73TP##.knxprod**
(## = version, download from www.ekinex.com)



Documentation

For more information see the technical documentation, download from www.ekinex.com



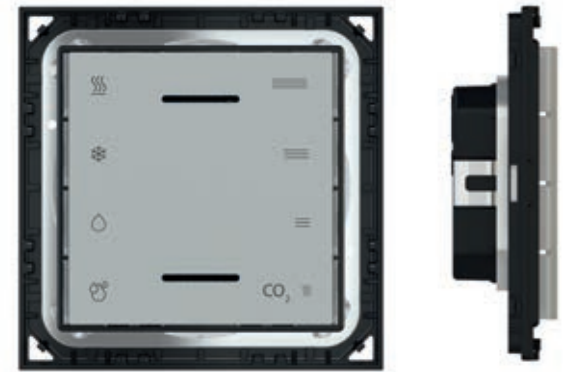

Multisensor quality air with regulator

WALL-MOUNT DEVICES

Description

The Ekinex® multisensor 71 series detects values of temperature, relative humidity and CO₂ equivalent concentration in an air mass. The device can act as a temperature regulator of a room or zone; it can also perform the regulation by thresholds of relative humidity and CO₂ concentration. The frontal LEDs indicate if the device is in heating, cooling, dehumidification or CO₂ threshold mode. The device integrates a KNX bus communication module and is intended for mounting onto a wall mounting box; it is supplied by a SELV voltage directly from the KNX bus and does not require any auxiliary power supply.

Main features

- Integrated temperature and relative humidity sensors
- Integrated VOCs (Volatile Organic Compounds) sensor with output signal for CO₂ equivalent
- Room thermostat function
- Threshold regulator function for relative humidity and CO₂
- LEDs for heating, cooling, dehumidification or CO₂ threshold mode indication
- Plastic casing
- Connection to bus line with KNX terminal block
- Frontal programming pushbutton and LED
- Wall-mounting installation on round or square wall box
- IP20 protection degree (installed)
- Weight 90 g (with mounting support)

Technical data

- 30 Vdc power supply by KNX bus
- Current consumption from bus < 13 mA

Delivery

Delivery includes a terminal block for connection to the bus, two pairs of fixing screws.

Accessories

The following accessories are available to be ordered separately:

- 1 full front cover with 60 x 60 mm modularity
- square and double frame Form or Flank version
- square, double and triple plate with 60 x 60 mm window
- a plastic adapter
- a metal support for installation onto round or square mounting box (fixing holes 60 mm apart)

Dimensions [mm]

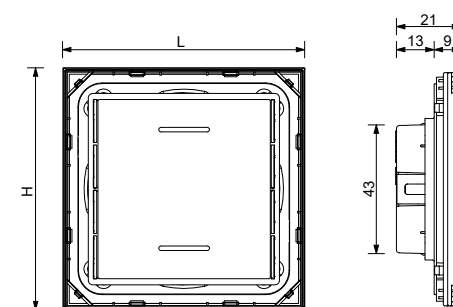

Mounting with frame: 81 x 77 (L x H)
Mounting without frame (NF): 80 x 80 (L x H)



Configuration and commissioning

By means of ETS5 software or later versions
Application program: **APEKET3TP##.knxprod**
(## = version, downloadable from www.ekinex.com)



Documentation

For more information see the technical documentation, download from www.ekinex.com



Multisensor quality air with regulator for rectangular wall-box

WALL-MOUNT DEVICES

Description

The Ekinex® multisensor 71 series detects values of temperature, relative humidity and CO₂ equivalent concentration in an air mass. The device can act as a temperature regulator of a room or zone; it can also perform the regulation by thresholds of relative humidity and CO₂ concentration. The frontal LEDs indicate if the device is in heating, cooling, dehumidification or CO₂ threshold mode. The device integrates a KNX bus communication module and is intended for mounting onto a wall mounting box; it is supplied by a SELV voltage directly from the KNX bus and does not require any auxiliary power supply.

Main features

- Integrated temperature and relative humidity sensors
- Integrated VOCs (Volatile Organic Compounds) sensor with output signal for CO₂ equivalent
- Room thermostat function
- Threshold regulator function for relative humidity and CO₂
- LEDs for heating, cooling, dehumidification or CO₂ threshold mode indication
- Plastic casing
- Connection to bus line with KNX terminal block
- Frontal programming pushbutton and LED
- Wall-mounting installation on round, square or rectangular wall box
- IP20 protection degree (installed)
- Weight 120 g (with mounting support)

Technical data

- 30 Vdc power supply by KNX bus
- Current consumption from bus < 13 mA

Delivery

Delivery includes a terminal block for connection to the bus, two pairs of fixing screws

Accessories

The following accessories are available to be ordered separately:

- 1 full front cover with 60 x 60 mm modularity
- rectangular frame Form or Flank version
- rectangular plate with 60 x 60 mm window
- a plastic adapter
- a metal support for installation onto round or square (fixing holes 60 mm apart) or rectangular (fixing holes 83,5 mm apart) mounting box

Dimensions [mm]

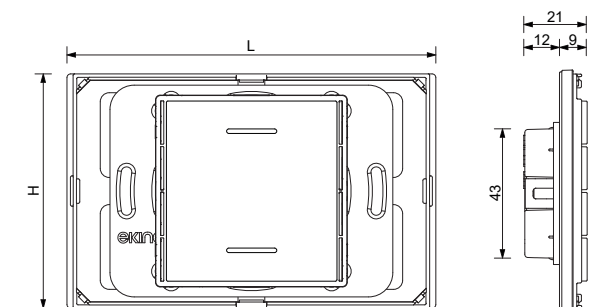

Mounting with frame: 122 x 77 (L x H)
Mounting without frame (NF): 120 x 80 (L x H)



Configuration and commissioning

By means of ETS5 software or later versions
Application program: **APEKET3TP##.knxprod**
(## = version, downloadable from www.ekinex.com)



Documentation

For more information see the technical documentation, download from www.ekinex.com



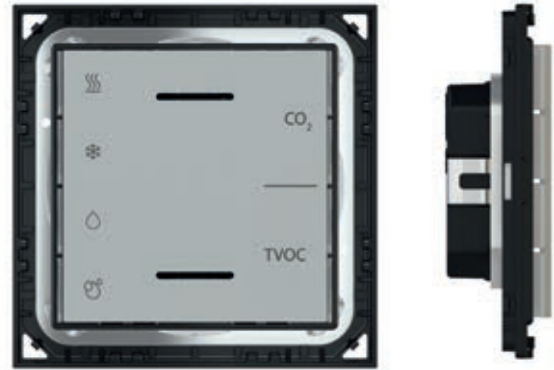

Multisensor with humidity, TVOC and CO₂ eq. regulator

WALL-MOUNT DEVICES

Description

The Ekinex® multisensor with controller is a KNX S-mode device for independent temperature control of a room or building area. The module includes 3 sensors: temperature, humidity percentage and air quality, expressed in terms of TVOC (Total Volatile Organic Compounds) or CO₂ equivalent. It can also function as a controller for these three quantities, valid for a single zone to be controlled. The front LEDs indicate the heating, cooling, dehumidification, humidification and TVOC or CO₂ threshold status. The push-button and the programming LED are located on the front in the area below the button. The device integrates a KNX bus communication module and is intended for mounting onto a wall mounting box; it is supplied by a SELV voltage directly from the KNX bus and does not require any auxiliary power supply.

Main features

- Integrated temperature and relative humidity sensors
- VOC (Volatile Organic Compounds) sensor with output signal for CO₂ equivalent and TVOC
- Room thermostat function
- Threshold regulator function for relative humidity, TVOC and CO₂
- Available an alarm signal on the CO₂ level also useful to obtain 1 LEED certification point
- Compatibility with Belimo actuators for the control of dampers in VAV boxes and 6-way valves
- Plastic casing
- Connection to bus line with KNX terminal block
- Frontal programming pushbutton and LED
- Wall-mounting installation on round or square wall box
- IP20 protection degree (installed)
- Weight 90 g (with mounting support)

Technical data

- 30 Vdc power supply by KNX bus
- Current consumption from bus < 13 mA
- Max. bus power < 390 mW

Delivery

Delivery includes a terminal block for connection to the bus, two pairs of fixing screws.

Accessories

The following accessories are available to be ordered separately:

- 1 full front cover with 60 x 60 mm modularity
- square and double frame Form or Flank version
- square, double and triple plate with 60 x 60 mm window
- a plastic adapter
- a metal support for installation onto round or square mounting box (fixing holes 60 mm apart)

Dimensions [mm]

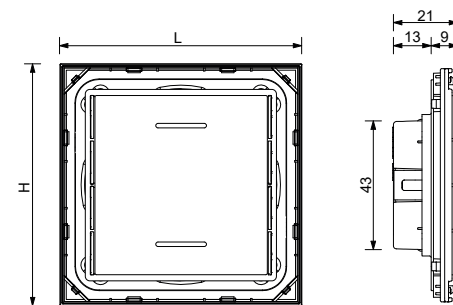

Mounting with frame: 81 x 77 (L x H)
Mounting without frame (NF): 80 x 80 (L x H)

Order information

Code	Mounting
EK-ES3-TP	with square and double frame Form or Flank version, without frame (NF version)



Configuration and commissioning

By means of ETS5 software or later versions
Application program: **APEKES3TP##.knxprod**
(## = version, downloadable from www.ekinex.com)



Documentation

For more information see the technical documentation, download from www.ekinex.com

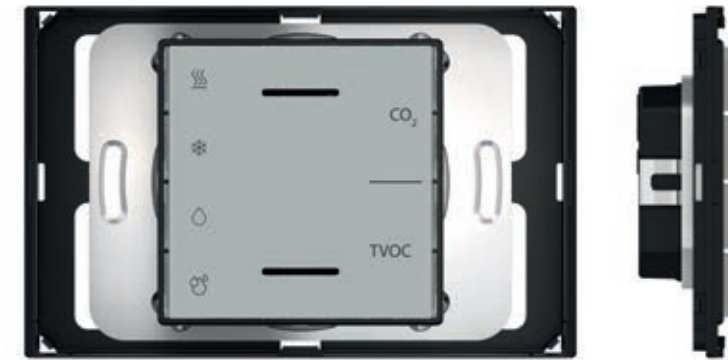

Multisensor with humidity, TVOC and CO₂ eq. regulator for rectangular wall-box

WALL-MOUNT DEVICES

Description

The Ekinex® multisensor with controller is a KNX S-mode device for independent temperature control of a room or building area. The module includes 3 sensors: temperature, humidity percentage and air quality, expressed in terms of TVOC (Total Volatile Organic Compounds) or CO₂ equivalent. It can also function as a controller for these three quantities, valid for a single zone to be controlled. The front LEDs indicate the heating, cooling, dehumidification, humidification and TVOC or CO₂ threshold status. The push-button and the programming LED are located on the front in the area below the button. The device integrates a KNX bus communication module and is intended for mounting onto a wall mounting box; it is supplied by a SELV voltage directly from the KNX bus and does not require any auxiliary power supply.

Main features

- Integrated temperature and relative humidity sensors
- VOC (Volatile Organic Compounds) sensor with output signal for CO₂ equivalent and TVOC
- Room thermostat function
- Threshold regulator function for relative humidity, TVOC and CO₂
- Available an alarm signal on the CO₂ level also useful to obtain 1 LEED certification point
- Compatibility with Belimo actuators for the control of dampers in VAV boxes and 6-way valves
- Plastic casing
- Connection to bus line with KNX terminal block
- Frontal programming pushbutton and LED
- Wall-mounting installation on round, square or rectangular wall box
- IP20 protection degree (installed)
- Weight 120 g (with mounting support)

Technical data

- 30 Vdc power supply by KNX bus
- Current consumption from bus < 13 mA
- Max. bus power < 390 mW

Delivery

Delivery includes a terminal block for connection to the bus, two pairs of fixing screws.

Accessories

The following accessories are available to be ordered separately:

- 1 full front cover with 60 x 60 mm modularity
- rectangular frame Form or Flank version
- rectangular plate with 60 x 60 mm window
- a plastic adapter
- a metal support for installation onto round or square (fixing holes 60 mm apart) or rectangular (fixing holes 83,5 mm apart) mounting box

Dimensions [mm]

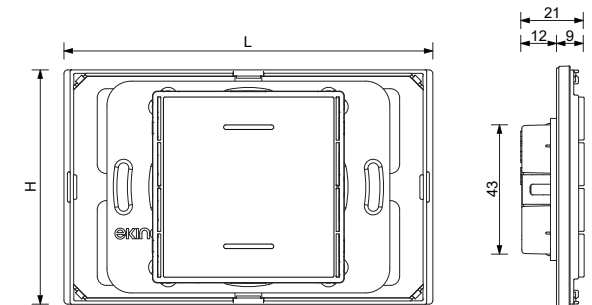

Mounting with frame: 122 x 77 (L x H)
Mounting without frame (NF): 120 x 80 (L x H)

Order information

Code	Mounting
EK-ES3-TP	with square and double frame Form or Flank version, without frame (NF version)



Configuration and commissioning

By means of ETS5 software or later versions
Application program: **APEKES3TP##.knxprod**
(## = version, downloadable from www.ekinex.com)



Documentation

For more information see the technical documentation, download from www.ekinex.com





TOUCH&CONTROL

WALL-MOUNT DEVICES



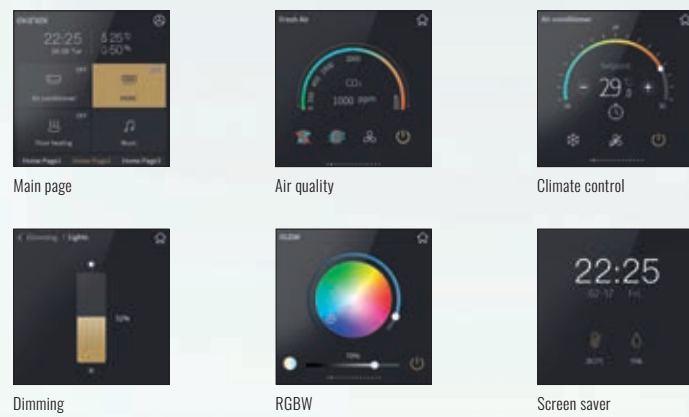

Main page

Air quality

Climate control

Dimming

RGBW

Screen saver

Touch&Control

WALL-MOUNT DEVICES

Designed to integrate into any building. Touch&Control is the new KNX capacitive touch-screen with compact dimensions but great performance. The 4" colour IPS display is a perfect combination of design and technology.



86 x 101,3 x 10,5 mm

Touch&Control

WALL-MOUNT DEVICES



Touch & Control is a touch display device designed for independent temperature control and control of KNX devices in a building.

The Ekinex® EK-EI2-TP-4 device is a KNX S-mode appliance designed for the independent regulation of the temperature of a room or an area of a building. It also allows to view the status and control a variety of KNX devices by touching the icons on the touch display interface to perform some pre-set functions: room thermostat, ON/OFF control of utilities, scenes activation, control of motorized drives for blinds (such as roller shutters, curtains, venetian blinds or roller shutters), control and dimming of lighting devices, logics and other functions via bus.

The device is primarily designed for use in the control system of houses and buildings. Wall installation is envisaged, with assembly in conventional junction boxes as per the Ekinex® planner (which can be reached at <https://planner.ekinex.com/>). The product is suitable not only for European standards, but also for Chinese and American ones. It is powered by the KNX bus and requires a 24-30 Vdc auxiliary power supply. Physical addressing and parameter configuration can be carried out using the ETS KNX software (starting from version 5.7) with the .knxprod file.

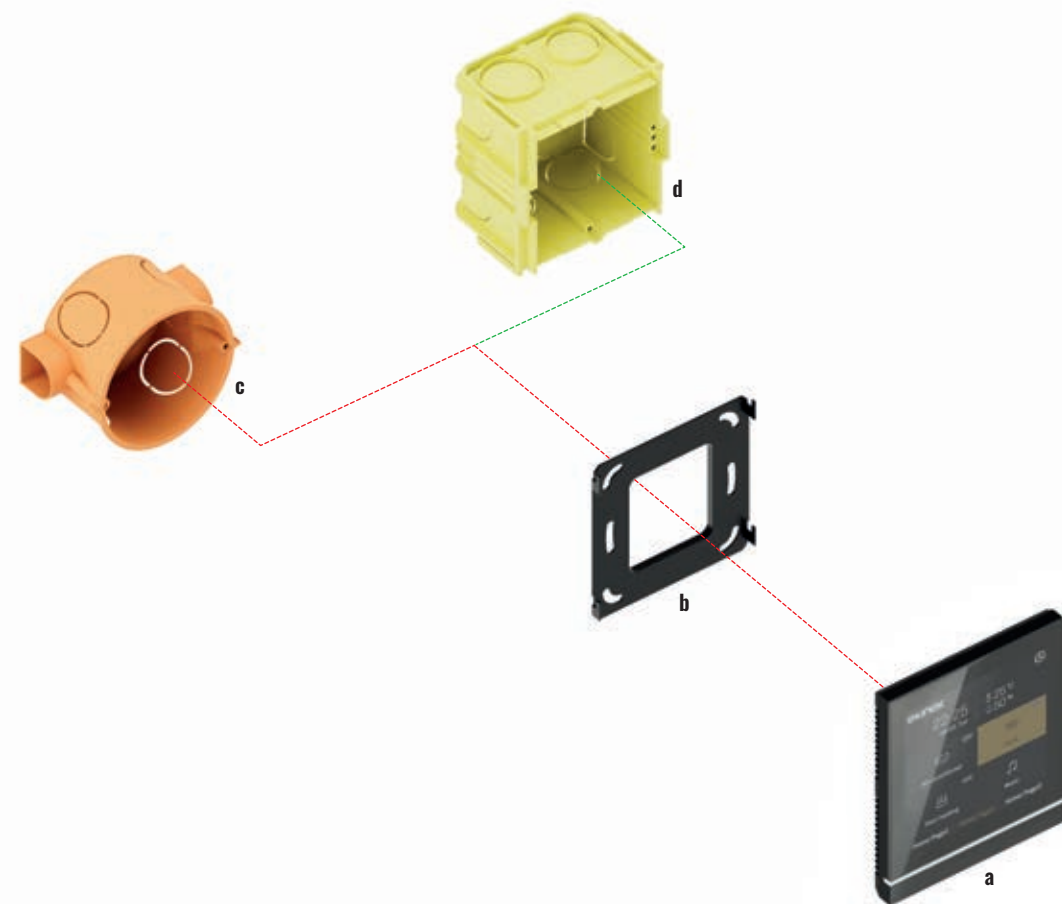

Touch&Control	
Description	Code
a) Touch&Control 4"	EK-EI2-TP-4
b) Mounting support (included in delivery)	
c) Round flush-mounting box	not delivered by Ekinex®
d) Square flush-mounting box	not delivered by Ekinex®

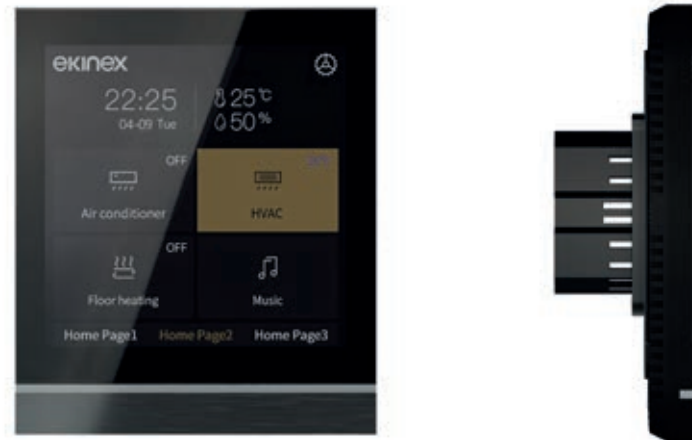

Touch&Control 4''

WALL-MOUNT DEVICES

Description

Designed to integrate into any building, the KNX Touch&Control 4'' display is a perfect combination of design and technology. The display provides users with a wide range of KNX functions allowing control of one or more rooms. The device is equipped with an LED that can be used for night orientation or to inform users of any alarms, which in combination with the integrated proximity sensor allows the screen to be switched on or off automatically. A dedicated widget is available for each type of automation: lights, dimmers, RGB, RGBW, blinds, audio solutions, air conditioning, air quality and 4 temperature control zones are just some of the functions integrated in this display.

Main features

- Control and dimming functions for luminaires, motorised shutter control
- Room thermostat function for 4 independent zones
- Control of room temperature, air conditioning, underfloor heating and ventilation system
- Control of audio functions
- RGB, RGBW, RGBCW brightness control and colour temperature setting
- Air quality display, with PM2.5, AQI, CO2, VOC etc.
- Display of energy measurement parameters: current, voltage, power, energy.
- 8 time functions, 8 scene group functions
- 8 logic functions, with AND, OR, XOR, logic port forwarding, threshold comparator, format conversion
- Delay and staircase light function
- Integrated proximity sensor, screen brightness setting, indication with coloured LED strip
- Haptic feedback with vibration
- Date and time display, temperature and humidity display, day/night status output
- Password protection, screen saver and panel lock
- Alarm function

- Integrated temperature sensor
- Weekly timer
- Dimensions (WxHxD): 86 x 101.3 x 10.5mm (32.2mm)
- Weight: 200 g

Technical data

- Power supply 21-30 Vdc via KNX bus and current consumption 4mA@30Vdc
- SELV auxiliary power supply 12-30 Vdc and current consumption < 71mA@30Vdc
- 4'' colour IPS capacitive touch screen, resolution 480x480 pixels
- Proximity sensor activation distance: approx. 30 cm
- Dimensions (WxHxD): 86 x 101.3 x 10.5 mm

Delivery

The supply includes two terminals for connection to the bus line and auxiliary power supply.

Dimensions [mm]

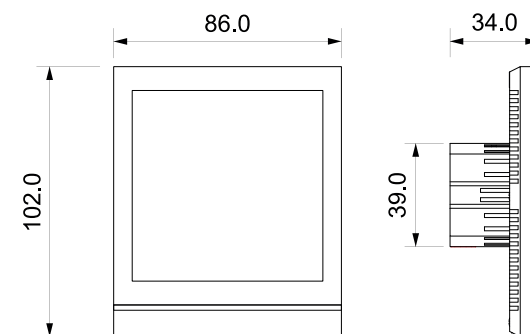

Order information

Code	Mounting
EK-EI2-TP-4	without frame



Documentation

For more information see the technical documentation, download from www.ekinex.com



Configuration and commissioning

By means of ETS5 software or later versions
Application program: **APEKEI2TP##.knxprod**
(## = version, downloadable from www.ekinex.com)





.....
HOTEL SOLUTIONS
.....

WALL-MOUNT DEVICES

Card reader	130
Card holder	131
Card programmer	132
Desktop cards programmer kit	133
Accédo Software	134
Smart-card	135
Router Tosibox® Lock	136
USB Tosibox® Key	137



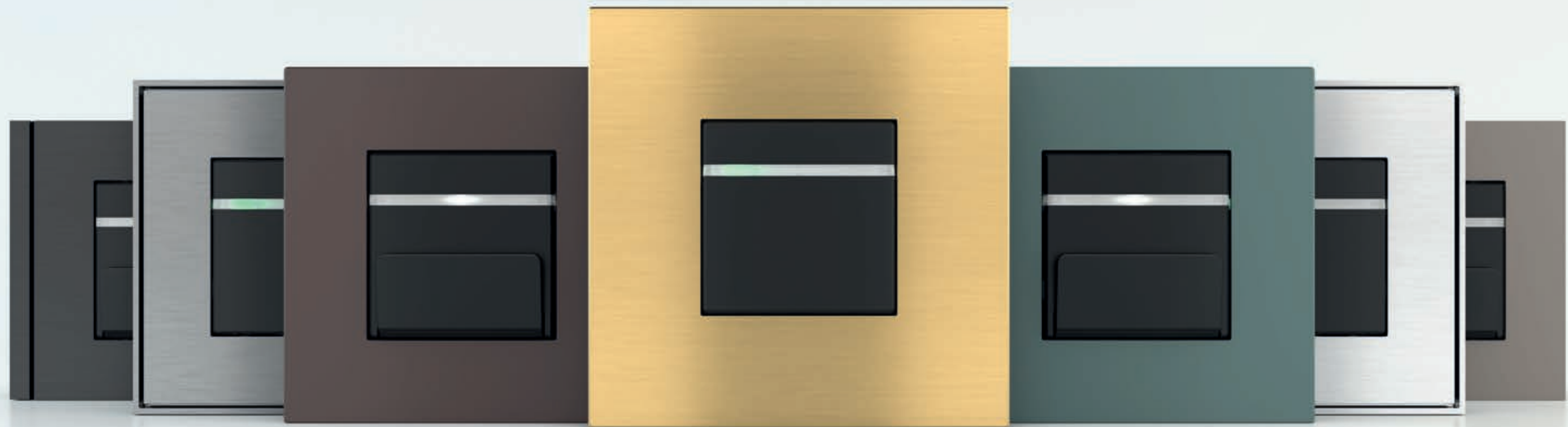

Hotel solutions

WALL-MOUNT DEVICES

Ideal for building automation functions in accommodation and hospitality facilities Ekinex offers advanced solutions for the automation of accommodation facilities, designed to offer guests comfort and environmental quality and high energy efficiency to managers and owners.

Available colour solutions

	Form	Flank	'NF	Deep	Surface	Card reader Card programmer
	Frames		Plates			
Plastic	•	•	•	•	-	-
Metal	•	•	•	•	•	-
Metal HT	-	-	-	•	•	-
Fenix NTM®	-	-	•	•	•	-

For more information see page 214



86 x 86 x 8 mm
Form



94 x 86 x 8 mm
Flank



80 x 80 x 8 mm
'NF



86 x 86 x 9 mm
Deep



98 x 98 x 3 mm
Surface

Access control

WALL-MOUNT DEVICES

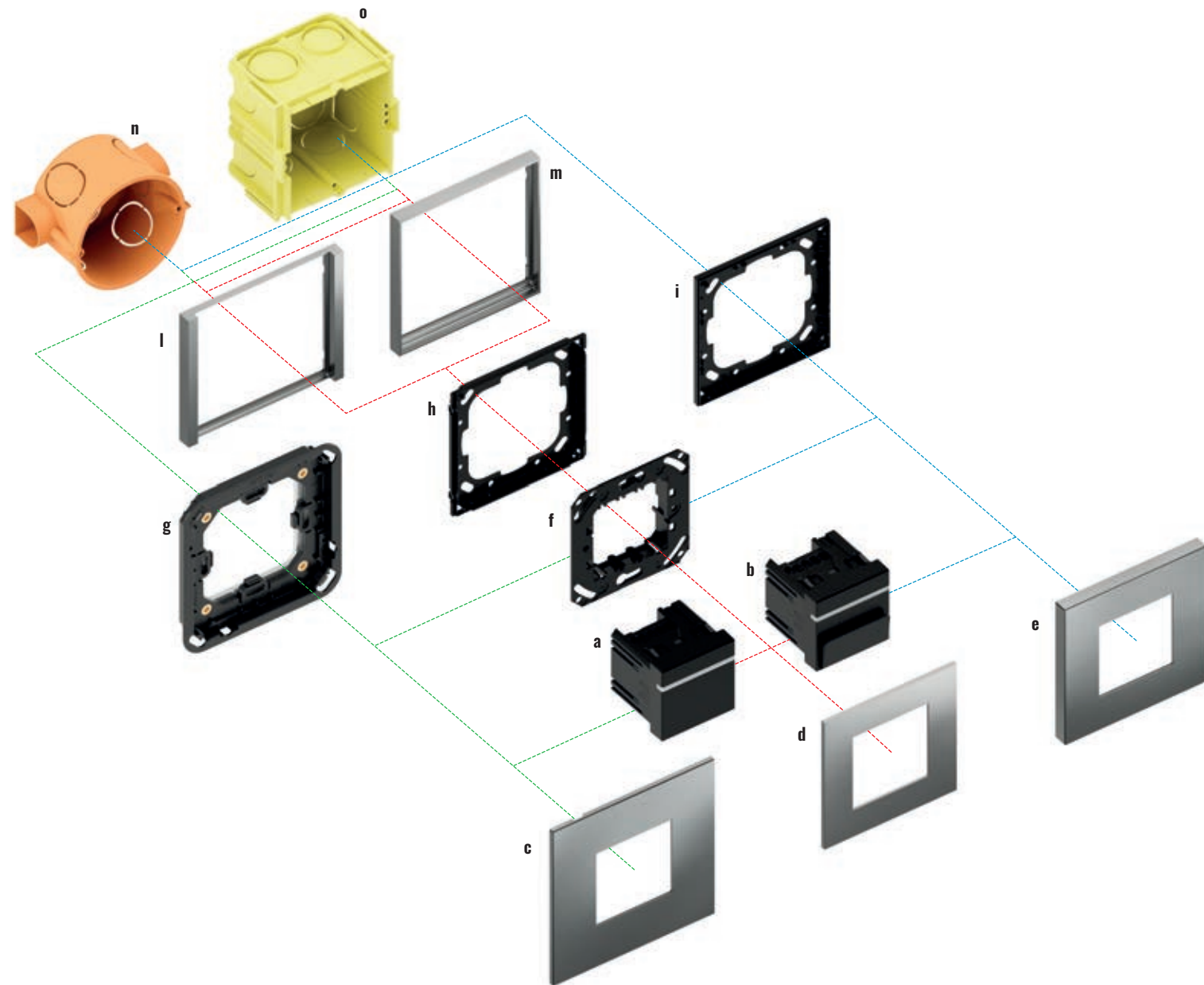

Access control

Description	Code
a) Card reader	EK-TR2-TP
b) Card holder	EK-TH2-TP
c) Square plate Surface version*	EK-SQG-...
d) Square plate*	EK-PQG-...
e) Square plate Deep version*	EK-DQG-...
f) Adapter for card holder and card reader	EK-SP-TX2
g) Adapter for Surface square plate	EK-TAS-Q-W or EK-TAS-Q-N

Description	Code
h) Adapter for square plate	EK-TAQE-1
i) Adapter for 'NF and Deep square plate	EK-TAQE-1-NF
j) Square frame of Flank version	EK-FLQ-...
k) Square frame of Form version	EK-FOQ-...
l) Round flush-mounting box	not delivered by Ekinex®
m) Square flush-mounting box	not delivered by Ekinex®

*j) 45 x 45 mm window

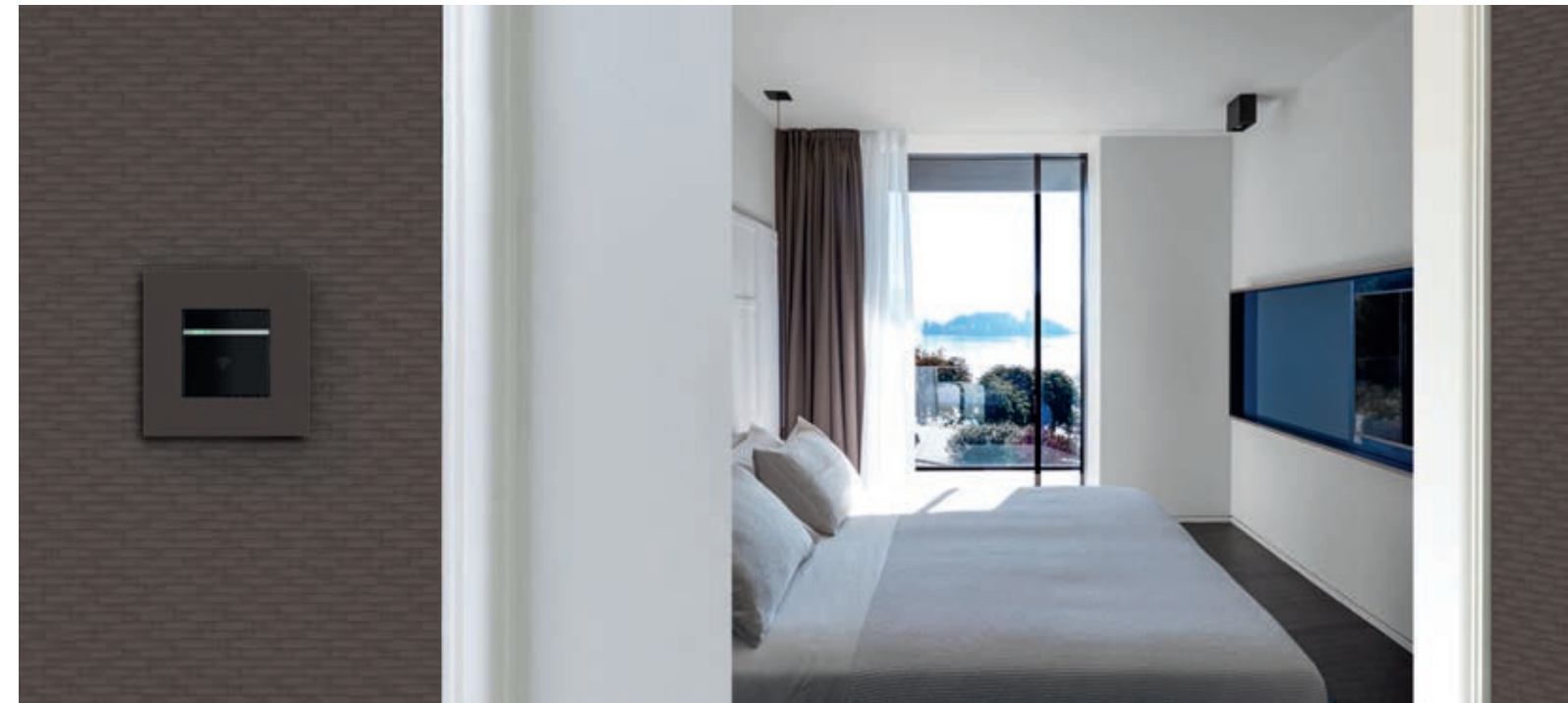

The use of Ekinex® temperature control devices in combination with the system for access and presence detection, makes it possible to offer guests of a hotel maximum comfort and, at the same time, to safeguard the objectives of energy efficiency and cost savings defined in the technical and economic planning.

KNX devices series for controlled access to rooms and for detection of presence by means of smart-cards. Ideal for creating KNX standard automation functions in hospitality and hospitality structures (hotels, residences, guest houses or bed & breakfasts) with the aesthetic uniformity of Ekinex® wall products (push-button controls and room thermostats), in combination with products from switchboard (EK-H01-TP and EK-HU1-TP controllers) and with the Ekinex® Accédo management and supervision software.

The products are equipped with an RFID-type front antenna capable of feeding the smart-card that is approached and reading the programmed information. The EK-TR2-TP wall reader enables access following validation of the card based on the configured authorizations. The EK-TH2-TP wall pocket activates presence following the insertion of the card in the appropriate front pocket. Both products can manage guest cards of the accommodation facility, based on the system codes, the reservation and the check-in / check-out period, service cards based on time slots and pass-dates. To program cards, use the product EK-TP2-TP, which is very similar to the reader with the possibility of activating the front antenna also for writing operations.



The programming of the cards in the reception area as well as the activation of a reader outside the room and an inside pocket takes place on the KNX network infrastructure. In addition to the power supplied by the KNX bus, an external auxiliary power supply is required for the RFID antenna at 12/24 Vac / dc. The basic programming of the devices as well as the configuration of the automation functions is carried out through the ETS application program: card programming and enabling room and controlled access devices in common areas requires the use of Ekinex® Accédo management and supervision software. Both devices can notify the passage and validation events of each type of card via the KNX bus with an internal buffer to cope with the unavailability of the communication bus due to excessive data traffic.



Card reader

WALL-MOUNT DEVICES

Description

The Ekinex® EK-TR2-TP card reader with RFID technology is used for access control in combination with the EK-TH2-TP card holder pocket. Equipped with a bi-stable relay (4A@24Vac/dc), an input for potential-free contacts and a 3-colour front signal LED (white, green and red). The device has an integrated KNX bus communication module and is designed for wall mounting in a flush-mounted box; it is supplied with SELV voltage via the KNX bus and requires an auxiliary power supply at 12-24 Vac/dc.

Functionality

- Access control via KNX TP bus (twisted pair)
- Enabling access after card validation
- Management of the guest based on the booking and the check-in/check-out time: management of users based on time slots and passe-partouts
- Programmable output for electric lock activation or as simple actuator activated by KNX telegrams
- Validation in progress signalling (green led) or unauthorized card (red led); possibility of enabling the “ don't disturb” or “camera remake” commands
- Notification of validation events to supervisory system with memory buffer

Main features

- Plastic casing
- Bus line connection via KNX terminal
- Recessed wall mounting on round box
- Degree of protection IP20 (installed)
- Weight 50 g (with mounting bracket)

Technical data

- 30 Vdc power supply via KNX bus
- Auxiliary power supply 12-24 Vac/dc
- Current consumption from the bus < 10 mA

Delivery

Delivery includes a terminal block for connection to the bus, two pairs of fixing screws.

Accessories

The following accessories are available to be ordered separately:

- Smart-card EK-TCE-10 (Ekinex logo in black, pack of 10 cards) or EK-TCC-10 (personalised with customer logo, on request)
- square frame Form or Flank version
- square plate with 45 x 45 mm window
- a plastic adapter

Dimensions [mm]

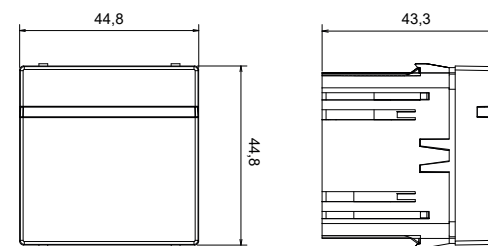

Order information

Code	Mounting	Package
EK-TR2-TP	square plate with 45x45 mm window optional frame Form or Flank version	1 pcs.



Configuration and commissioning

Ekinex® Accédo software for programming access control functions and cards.
Project file: **APEKTRPTH2TP#.knxproj** (downloadable from www.ekinex.com)



Documentation

For more information see the technical documentation, download from www.ekinex.com



Card holder

WALL-MOUNT DEVICES

Description

The Ekinex® EK-TH2-TP card holder with RFID technology is used for presence detection in combination with the EK-TR2-TP card reader. Equipped with a bistable relay (4A@24Vac/dc), an input for potential-free contacts and a front signal LED (white). The luminaire has an integrated KNX bus communication module and is designed for wall mounting in a flush-mounted box; it is supplied with SELV voltage via the KNX bus and requires an auxiliary power supply at 12-24 Vac/dc.

Functionality

- Presence detection via bus and communication to supervision system via KNX TP bus (twisted pair)
- Enabling presence after inserting the card into the front pocket
- Guest management of the structure according to the booking and the check-in/check-out period: user management according to time slots and passe-partouts
- Output programmable according to card validation or as actuator activated by KNX telegrams. Delay to card extraction configurable for courtesy light management
- Binary input available for connection of conventional button (with switching, dimming or roller shutter/awning function) or signal contact (e.g. window opening)
- White front LED: flashing when the card is not inserted, off when the card is inserted; LED control via KNX bus telegrams possible
- Notification of presence events detected to supervision system with memory buffer

Main features

- Plastic casing
- Bus line connection via KNX terminal
- Recessed wall mounting on round box
- Degree of protection IP20 (installed)
- Weight 50 g (with mounting bracket)

Technical data

- 30 Vdc power supply via KNX bus
- Auxiliary power supply 12-24 Vac/dc
- Current consumption from the bus < 10 mA

Delivery

Delivery includes a terminal block for connection to the bus, two pairs of fixing screws.

Accessories

The following accessories are available to be ordered separately:

- Smart-card EK-TCE-10 (Ekinex logo in black, pack of 10 cards) or EK-TCC-10 (personalised with customer logo, on request)
- square frame Form or Flank version
- square plate with 45 x 45 mm window
- a plastic adapter

Dimensions [mm]

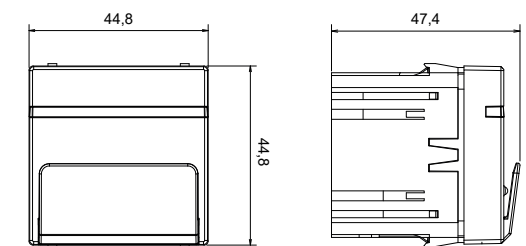

Order information

Code	Mounting	Package
EK-TH2-TP	square plate with 45x45 mm window optional frame Form or Flank version	1 pcs.



Configuration and commissioning

Ekinex® Accédo software for programming access control functions and cards.
Project file: **APEKTRPTH2TP#.knxproj** (downloadable from www.ekinex.com)



Documentation

For more information see the technical documentation, download from www.ekinex.com





Cards programmer

WALL-MOUNT DEVICES

Description

The Ekinex® EK-TP2-TP card programmer with RFID technology is used for programming cards to be used with the EK-TR2-TP card reader and the Ekinex EK-TH2-TP card holder. Equipped with a bi-stable relay (4A@24Vac/dc) and an input for potential-free contacts the device has an integrated KNX bus communication module and is designed to be mounted in a flush-mounted wall box; it is supplied with SELV voltage via the KNX bus and requires an auxiliary power supply at 12-24 Vac/dc.

Functionality

- Programming of cards via KNX TP bus (twisted pair) and Ekinex Accédo software
- Card programming with different user profiles: guest, staff and passe-partouts
- Guest booking management and check-in/check-out operation
- Card activation based on time slots for service personnel
- Event notification to the supervision system with memory buffer

Main features

- Plastic casing
- Bus line connection via KNX terminal
- Recessed wall mounting on round box
- Degree of protection IP20 (installed)
- Weight 50 g (with mounting bracket)

Technical data

- 30 Vdc power supply via KNX bus
- Auxiliary power supply 12-24 Vac/dc
- Current consumption from the bus < 10 mA

Delivery

Delivery includes a terminal block for connection to the bus, two pairs of fixing screws.

Accessories

The following accessories are available to be ordered separately:

- Smart-card EK-TCE-10 (Ekinex logo in black, pack of 10 cards) or EK-TCC-10 (personalised with customer logo, on request)
- square frame Form or Flank version
- square plate with 45 x 45 mm window
- a plastic adapter

Dimensions [mm]

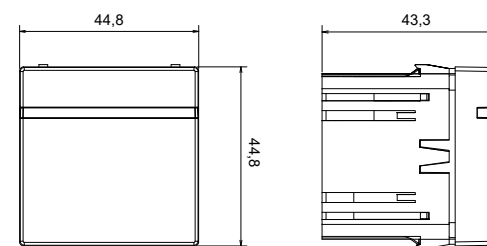

Order information

Code	Mounting	Package
EK-TP2-TP	square plate with 45x45 mm window optional frame Form or Flank version	1 pcs.

Configuration and commissioning

Ekinex® Accédo software for programming access control functions and cards.
Project file: **APEKTRPTH2TP##.knxproj** (downloadable from www.ekinex.com)

Documentation

For more information see the technical documentation, download from www.ekinex.com



Desktop cards programmer kit

WALL-MOUNT DEVICES

Description

The card programmer kit is a table-top control panel, coordinated with the aesthetic lines of the Ekinex® wall-mounted products, to be installed at one or more reception points in an accommodation facility, in combination with the KNX standard products for controlled access to rooms and public areas EK-TR2-TP and EK-TH2-TP and the Ekinex® Accédo EK-ACC-SW supervision and card programming software.

Functionality

The programmer kit, suitable for reception desks in hospitality facilities such as hotels and reception centres, is equipped with an elegant frame in pre-painted aluminium in bromine grey and performs the following functions:

- Programming smart-cards with RFID (Radio Frequency Identification) technology, 13.56 MHz frequency, Mifare Classic 1kB protocol
- Signaling via buzzer of the bathroom tie rod alarms
- Alarm silencing through manual button

Main features

- 1 KNX transponder card programmer cod. EK-TP2-TP
- 1 universal KNX interface EK-CC2-TP (2 IN / 2 OUT)
- 1 buzzer 12Vac, 5VA anthracite Colour
- 1 push button 1P NO, 10A at 250Vac anthracite Colour

The external power supply not included in the supply must be made with transformer 12Vac 1A. The card programmer and the universal interface with 2 inputs and 2 outputs must be connected to the KNX TP bus (twisted pair) by means of the red-black terminal provided.

Other features

- card programming with RFID technology, 13.56 MHz frequency, Mifare protocol, Classic 1 KB
- 4M table-top box, Colour grey, with plastic housing
- Degree of protection IP20 when installed (according to EN 60529)
- Insulation class II (according to EN 60335-1)
- Climatic classification 3K5 (indoor use, dry) and mechanical classification 3M2 (according to EN50491-2)
- Device weight: 250 g
- Dimensions 148,8 x 92 x 25,1 mm (W x H x D)

Environmental conditions

- Operating temperature: 0°C ... + 40°C
- Storage temperature: - 10 ... + 70°C
- Transport temperature: - 10 ... + 70°C
- Relative humidity: 95% non condensing

Dimensions [mm]

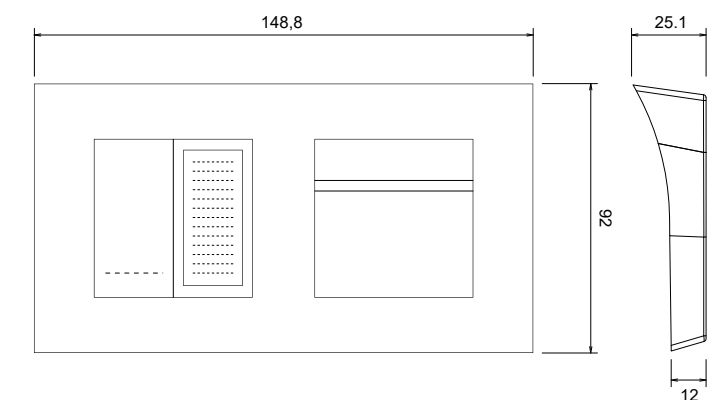

Order information

Code	Mounting	Package
EK-TPBOX-TP	plate with 45x45 mm windows	1 pcs.

Configuration and commissioning

Ekinex® Accédo software for programming access control functions and cards.
Project file: **APEKTRPTH2TP##.knxproj** (downloadable from www.ekinex.com)

Documentation

For more information see the technical documentation, download from www.ekinex.com





Accédo software

SOFTWARE

Description

Software for the management of systems technology, particularly suitable for hotels, residences, guest houses or bed&breakfast. Client-servers' architecture with HTML5 server functionality. Programming of transponder cards for access control, presence detection and (optional) electronic money functionality. Automatic import of ETS projects with easy and intuitive creation of graphic pages, drag&drop functionality, advanced copy/paste and undo/redo. Integrated control of calendars, scenarios and schedules. Interface to other communication protocols such as BACnet, Modbus, M-Bus, etc.

Requirements

- Operating System: Windows 10 - I/O RS232
- Processor: Intel Core i5 3.3 GHz or higher
- RAM memory: min. 4 GB
- SSD: 240 GB
- Resolution: Full HD

Order information

Code	Composition	Package
EK-ACC-L15	Software License up to 15 reader	1 pcs.
EK-ACC-L30	Software License up to 30 reader	
EK-ACC-L50	Software License up to 50 reader	
EK-ACC-L100	Software License up to 100 reader	
EK-ACC-L200	Software License up to 200 reader	
EK-ACC-LC	Client License for additional programming workstation	



Documentation

For more information see the technical documentation, download from www.ekinex.com



Smart-card

ACCESSORIES

Description

Smart-card with RFID technology to be used with the EK-TR2-TP reader and the EK-TH2-TP card holder for controlled access to rooms and for presence detection in accommodation and hospitality facilities (hotels, residences, guest houses or bed&breakfast).

Order information

Code	Customization	Package
EK-TCE-10	Ekinex® logo in black colour	10 pcs.
EK-TCC-10	personalized with customer logo	on request



Configuration and commissioning

The **EK-TP2-TP** card programming device and the **Ekinex® Accédo software**, dedicated to the management of accommodation and hospitality facilities, are required for card programming.





Tosibox® Lock router

REMOTE ASSISTANCE

Description

It establish a secure connection via VPN (Virtual Private Network) tunnel with an automation system. The connection can be made via a PC or with one or more iOS or Android smartphone users. If a KNX/IP interface/router is installed on the KNX standard automation system, it can be accessed remotely directly via ETS. Quick and easy physical association between the Lock module and the Key and realization of a point-to-point VPN via the MatchMaking service. Remote connection of installations with Internet connection with dynamic, static and private IP. Possibility to connect modems with 2G/3G/4G radiotelephone network.

Dimensions [mm]

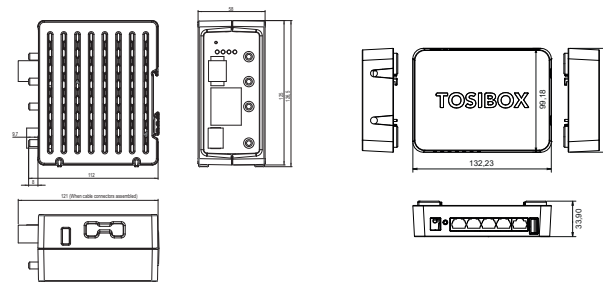

	Tosibox® Lock 150	Tosibox® Lock 500	Tosibox® Lock 500i
General features			
Power supply	12/24Vdc, with Jack, power supply included	12/48Vdc with connector, power supply not included	12/48Vdc with connector, power supply not included
Installation	external	DIN Rail	DIN Rail
Dimension	132 x 99 x 35.5 mm	110 x 58 x 127 mm	110 x 58 x 127 mm
Temperature range	-20 °C ... +55 °C	-20 °C ... +60 °C	-20 °C ... +60 °C
Degree of protection	IP20	IP20	IP20
Connections			
WAN		1xRJ45 – 10/100TX	
LAN		3xRJ45 – 10/100TX (one door for local service access)	
WiFi		Client mode e Access Point, 802.11b/g/n	
2G/3G/4G	External modem	External modem	Integrated dual-SIM modem
VPN Features			
VPM throughput	10 Mbps	70 Mbps	70 Mbps
VPN Encryption		Blowfish 128 bit CBC, AES 128/192/256 bit CBC	
VPN Authentication		PKI, 3072 bit RSA	
Certifications			
	CE, FCC	CE, FCC, UL	CE, FCC, UL

Order information

Code	Composition	Package
EK-DEL-TBL1	Tosibox® Lock 150 Router, external installation, for VPN connections with automation system	
EK-TBL5	Tosibox® Lock 500 Router, DIN rail installation, for VPN connections with automation system	1 pcs.
EK-DEL-TBL5-SIM	Tosibox® Lock 500i Router, DIN rail installation, with integrated 2G/3G/4G dual SIM modem, for VPN connections with automation system	

Awards and recognitions



USB Tosibox® Key

REMOTE ASSISTANCE



Description

Quickly and securely create a Virtual Private Network (VPN) tunnel between a PC and one or more Lock routers and generate activation codes for iOS and Android VPN client apps on smartphones using 2048-bit RSA encryption. The Key can be configured as Master Key, Backup Key or Sub Key with limited access to a subset of installations. The Tosibox® SoftKey is a purely software key that can be combined with a Key to avoid transporting the physical dongle.

Supported operating systems

- Windows 8-10 (32/64 bit)
- Windows 7 (32/64 bit)
- Windows Vista (32/64 bit)
- Windows XP (SP3)
- Mac OS X Leopard 10.5 or newer

Order information

Code	Composition	Package
EK-DEL-TBK1	Key with Tosibox® Cryptographic microcontroller Key that makes 1 PC client + 1 mobile client	
EK-DEL-TBSK1	Tosibox® SoftKey software key to be combined with a key, with Sub Key function	
EK-DEL-TBMC1	Additional license for Tosibox® Key with 1 mobile client	1 pcs.
EK-DEL-TBMC5	Additional license for Tosibox® Key with 5 mobile clients	
EK-DEL-TBMC10	Additional license for Tosibox® Key with 10 mobile clients	



.....
SENSORS
.....
WALL-MOUNT DEVICES

Motion sensor	142
KNX Secure multi-function movement sensor	143
KNX Secure multifunctional presence sensor	144
Motion sensor for outdoor mounting	145

Sensors

WALL-MOUNT DEVICES

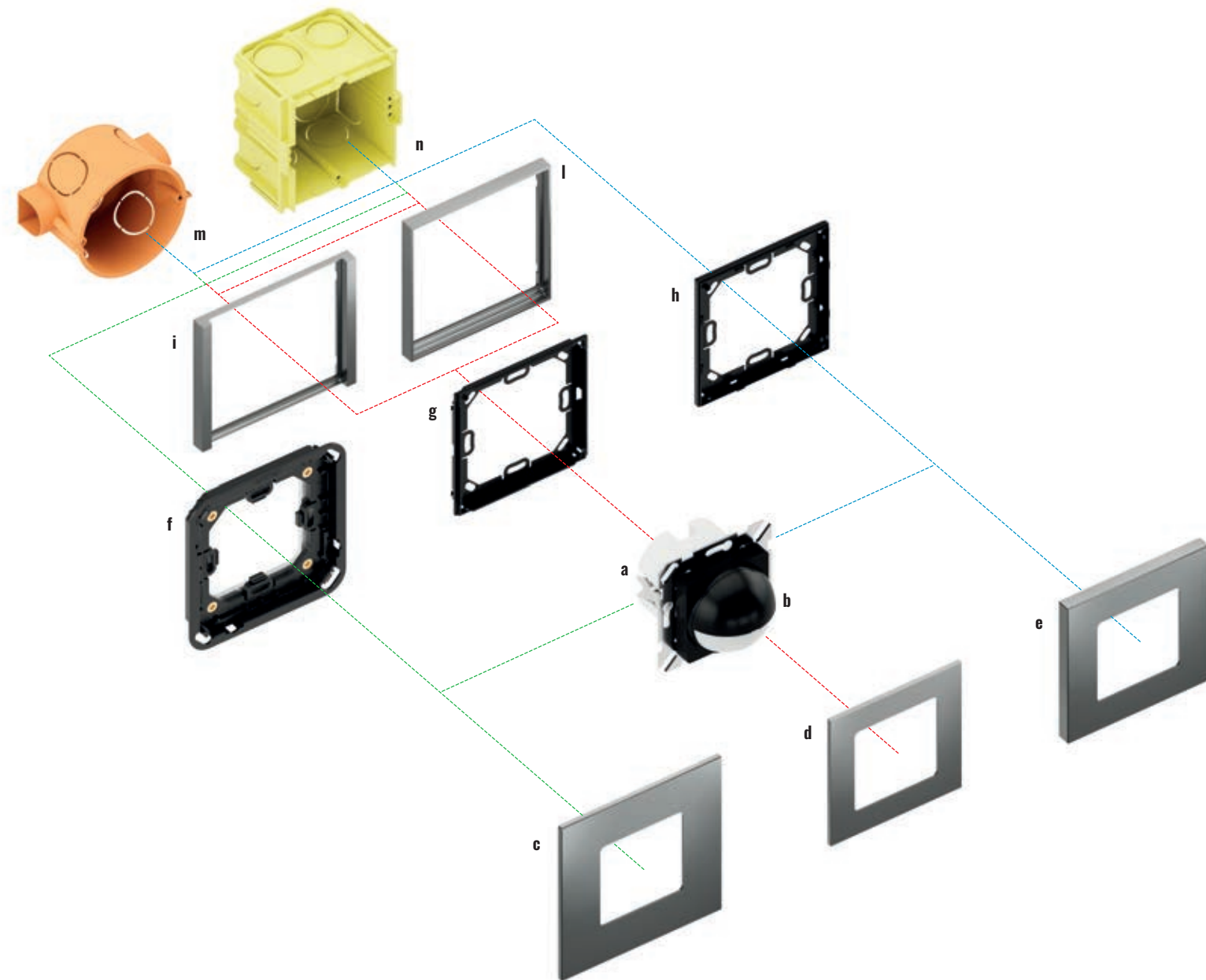

Motion sensor	
Description	Code
a) Motion sensor with metallic support	EK-SN2-TP-GA_
b) Cover with lens	
c) Square plate Surface version*	EK-SQN-...
d) Square plate*	EK-PQN-...
e) Square plate Deep version*	EK-DQN-...
f) Adapter for Surface square plate	EK-TAS-Q-W or EK-TAS-Q-N

Description	Code
g) Adapter for square plate	EK-TAQE-1
h) Adapter for 'NF and Deep square plate	EK-TAQE-1-NF
i) Square frame of Flank version	EK-FLQ-...
j) Square frame of Form version	EK-FOQ-...
m) Round flush-mounting box	not delivered by Ekinex®
n) Square flush-mounting box	not delivered by Ekinex®

*) 50 x 50 mm window

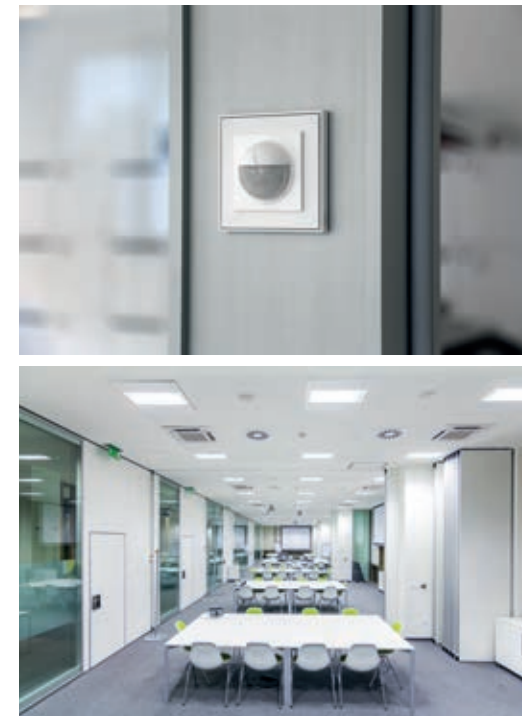

Motion sensors complete with frames Form, Flank or in the 'NF, Deep and Surface versions for aesthetics coordinated to the Ekinex® pushbuttons.

The Ekinex® range of motion and presence sensors allows you to automate the control of bus functions, such as lighting or room climate control. All versions contain a KNX communication module inside. The EK-DF2-TP and EK-DG2-TP versions are suitable for indoor ceiling mounting.

The EK-SN2-TP version is suitable for indoor wall mounting and must be completed with a square plate with 50 x 50 mm window and a square frame Flank or Form version, available in numerous material, colour and finish variants. The sensor can also be installed without a frame by separately ordering a square 'NF, Deep or Surface adapter available with a side profile in a choice of black or white (only 'NF). The EK-DH4-TP version is suitable for wall or ceiling mounting in outdoor areas.

The motion sensors are connected to the signal bus cable; they are SELV (Safety Extra Low Voltage) powered devices that offer a higher level of safety than conventional sensors. Configuration and commissioning of the devices is carried out using ETS® software; the relevant application programme can be downloaded from www.ekinex.com.



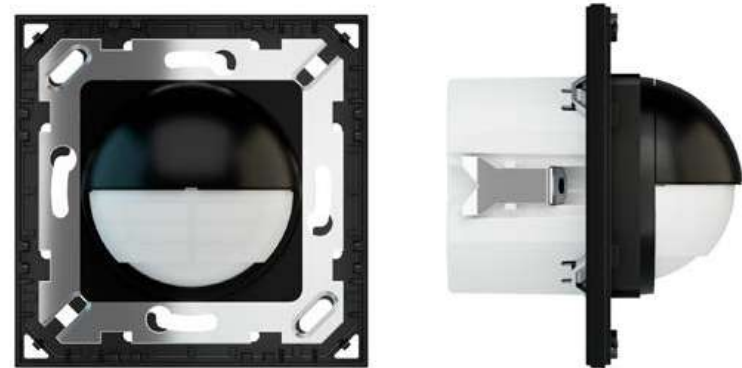

Motion sensor

WALL-MOUNT DEVICES

Description

The motion sensor Ekinex® EK-SN2-TP is used to detect the passage and standing of persons in a semicircular detection area. It is ideally suited for use in corridors, passage areas, toilets, stairwells, lift landings and generally environments with occasional occupancy. The device has dedicated channels for controlling lighting, HVAC equipment and alarms. Movement/presence detection is carried out by PIR (passive infrared) sensors; a sensor also allows the measurement of ambient brightness. The operating mode is semi-automatic or fully automatic. The device has an integrated KNX bus communication module and is designed for mounting in a flush-mounted wall box; it is powered via the KNX bus and does not require an auxiliary power supply. does not require an auxiliary power supply.

Main features

- Semi-automatic or fully automatic operation
- Two independent light control channels
- Two independent HVAC control channels
- One alarm channel
- An additional device can be used as a slave for any of the channels
- 200° detection range
- Adjustable sensitivity (4 levels)

Technical data

- Rated voltage: 21-30 VDC supplied by KNX bus
- Current consumption (on KNX bus): max. 10 mA (operation) / 5 mA (standby)
- Sensing range: 200° semicircular (maskable), up to 9 m distance at 1.5 m mounting height
- Light measurement range: 10..2000 Lux
- Plastic housing, lens and mount
- Safety standards: IEC 61000-6-1 / IEC 61000-6-3 / EN 55014 / EN 50491

Environmental Conditions

- Operating temperature: - 20... + 45 ° C
- Relative humidity: 95% non-condensing
- Environmental protection: IP20
- Switching, display and detection elements

Order information

Code	Lens colour	Package
EK-SN2-TP-GAA	white	1 pcs.
EK-SN2-TP-GAE	black	

The device is equipped with:

- (on the front side) a programming button
- (visible through the lens), a blue programming LED, a red
- red signal LED, a PIR sensor, a brightness sensor and an IR receiver.

Accessories

- The following accessories are available to be ordered separately:
- square frame Form or Flank version
- square plate with 50 x 50 mm window
- a plastic adapter



EK-SN2-TP-GAA



EK-SN2-TP-GAE

Dimensions [mm]

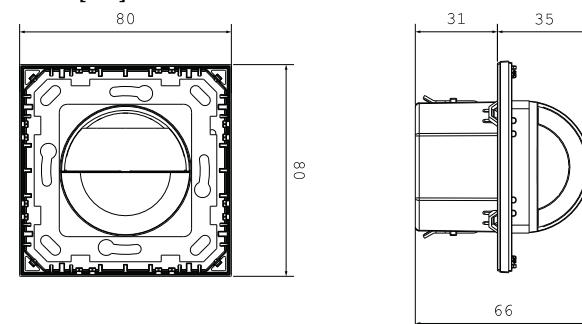

Configuration and commissioning

By means of ETS5 software or later versions
Application program: **APEKSN2TP##.knxprod**
(## = version, download from www.ekinex.com)



Documentation

For more information see the technical documentation, download from www.ekinex.com



KNX Secure multi-function movement sensor

WALL-MOUNT DEVICES

Description

The Ekinex KNX Secure multifunctional movement sensor can detect not only the movement of individuals but also brightness, air humidity and room temperature. Up to 4 channels are available for lighting (with constant brightness control) and temperature control functions. Despite its compact size, the sensor has a wide detection range and the functions within it make it suitable for any use, from residential to commercial.

Main features

- Detection of normal and small movements with PIR technology and directional lens
- Up to 4 output channels and up to 3 brightness levels for both the start and end situation
- Automatic and semi-automatic modes
- Built-in brightness sensor
- Built-in room temperature sensor
- Built-in air humidity sensor
- Constant brightness control
- Thermoregulation functions
- Advanced logic functions
- Master/slave working mode
- Configurable orientation light
- Support of the KNX data Secure protocol

Technical data

- 360° movement detection range up to 15.5m (at 6m height)
- Installation height approx. 2.5 - 6m
- Power supply 21-30 Vdc via KNX bus and current consumption 5.5mA@30Vdc
- Illumination measurement range 0-2000 lux
- Body diameter Ø 48.5 mm
- Outer diameter Ø 70 mm
- Mounting hole diameter Ø 53-55 mm
- Recess depth 37 mm

Order information

Code	Package
EK-SG2-TP-M	Sensor
EK-AMP-1	Wall mounting bracket

Accessories

The following accessories are available for completion and must be ordered separately:

- Wall mounting bracket EK-AMP-1



EK-AMP-1

Dimensions [mm]

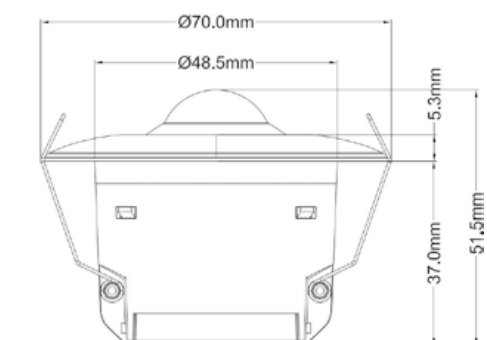

Configuration and commissioning

By means of ETS5 software or later versions
Application program: **APEKSG2TPM##.knxprod**
(## = version, download from www.ekinex.com)



Documentation

For more information see the technical documentation, download from www.ekinex.com





KNX Secure multifunctional presence sensor

WALL-MOUNT DEVICES

Description

With the KNX Secure multifunctional presence sensor with microwave technology it is possible to detect the actual presence of individuals in rooms. Due to its very high sensitivity to micro movements, its ideal use is in hotel rooms, offices and any place of sedentary presence.

Despite the multiple functionalities inside, the presence sensor comes in an ultra-compact design that is almost invisible in environments.

Main features

- Detection of normal and small movements with 24GHz microwave technology
- Up to 4 output channels and up to 3 brightness levels for both the start and end situation
- Automatic and semi-automatic modes
- Built-in brightness sensor
- Built-in room temperature sensor
- Built-in air humidity sensor
- Constant brightness control
- Thermoregulation functions
- Advanced logic functions
- Master/slave working mode
- Configurable orientation light
- Support of the KNX data Secure protocol

Technical data

- 360° static presence detection range up to 8.5m diameter (at 4m height)
- Installation height approx. 2.5-4 m
- Power supply 21-30 Vdc via KNX bus and current consumption 4mA@30Vdc
- SELV auxiliary power supply 12-30 Vdc and current consumption 20mA@30Vdc
- Illumination measurement range 0-2000 lux
- Body diameter Ø 48.5 mm
- Outer diameter Ø 65 mm
- Mounting hole diameter Ø 53-55 mm
- Recess depth 38 mm

Dimensions [mm]

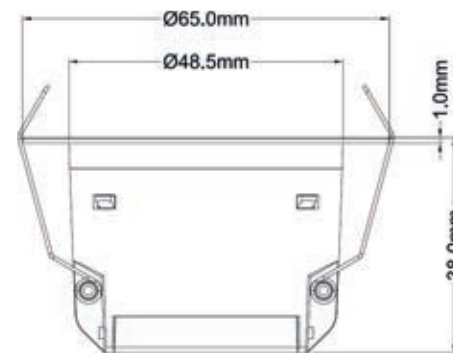

Configuration and commissioning

By means of ETS5 software or later versions
Application program: **APEKSG2TPP##.knxprod**
(## = version, download from www.ekinex.com)



Documentation

For more information see the technical documentation, download from www.ekinex.com



Order information

Code	Package
EK-SG2-TP-P	1 pcs.



Motion sensor for outdoor mounting

WALL-MOUNT DEVICES

Description

The Ekinex® EK-DH4-TP motion sensors an infrared motion detector passive (PIR) for outdoor ceiling or wall mounting, for motion and presence detection of people in outdoor spaces with a 360° coverage area. The detection area can be extended using other sensors configured as slave devices. One integrated light sensor, combined with the motion detector, can manage the ignition of light according to brightness level and presence. The device has two channels of separate output for lighting, with independent parameters; the operation can be automatic or semi-automatic. All the above listed parameters can be set by the user via ETS or via a dedicated IR remote control during installation. The device has two additional HVAC channels, which act similarly to brightness control channels, but without the standby time function and light level dependency. One additional alarm channel can activate or deactivate the load depending on the number of trigger events (movements) detected in a configurable time interval.

Main features

- Semi-automatic or fully automatic operation
- Two independent light control channels
- Two independent HVAC control channels
- An alarm channel
- An additional device can be used as a slave for any of the channels
- Detection range of 360° (180° on the wall), sectors can be masked through optic screens
- Adjustable sensitivity, with "Walk test" to verify the detection radius
- Parameters can be set by ETS or via an IR remote control.

Technical data

- Rated voltage: 24 VDC (21-30 VDC) supplied by KNX bus
- Current consumption (on KNX bus): max. 10 mA (operation) / 5 mA (standby)
- Sensing range: 360° circular (masking), **up to 32 m diameter at 2.5 m mounting height**
- Light measuring range: 10..2000 Lux
- Housing, lens and frame in plastic material
- Safety standards: IEC 61000-6-1 / IEC 61000-6-3 / EN 55014 / EN 50491

Environmental conditions

- Operating temperature: - 20 ... + 40°C
- Relative humidity: 95% not condensing
- Environmental protection: IP20

Switching, display and detection elements

The device is equipped with:

- on the rear side, a programming pushbutton
- visible through the plastic lens, a blue programming LED, a red signalling LED, a PIR sensor, a brightness sensor and an IR receiver

Accessories

The following accessories are available to be ordered separately:

- IR Remote Controller - EK-QR6-IR



Dimensions [mm]

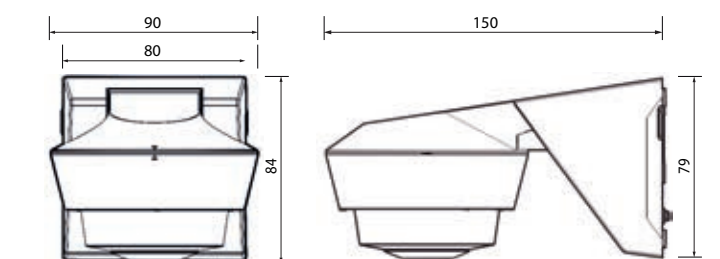

Configuration and commissioning

By means of ETS5 software or later versions
Application program: **APEKDH4TP##.knxprod**
(## = version, download from www.ekinex.com)



Documentation

For more information see the technical documentation, download from www.ekinex.com



Order information

Code	Package
EK-DH4-TP	1 pcs.



POWER SOCKETS / KEYSTONE SYSTEM

WALL-MOUNT DEVICES

Power socket Italian version (standard and USB A-C)	164
Power socket Schuko version (standard and USB A-C)	165
Power socket French version (standard and USB A-C)	166
Power socket UK version (standard and USB A-C)	167
Keystone System	176



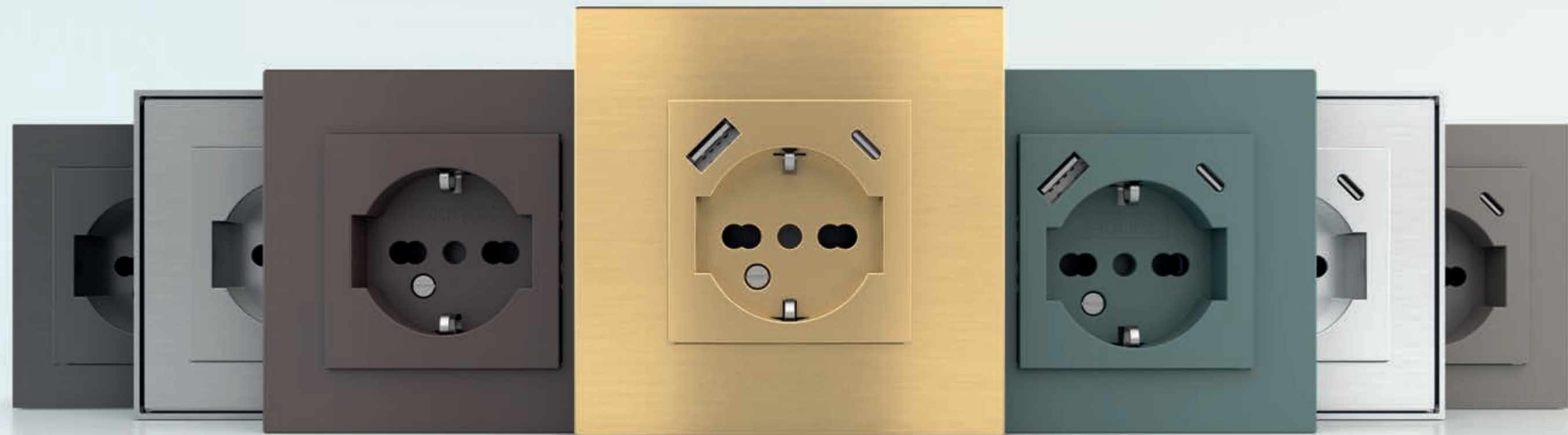

Power socket Italian Version (standard and USB A-C)

WALL-MOUNT DEVICES

The new Ekinex Italian standard sockets are available in a dual-step version (10-16A) with and without USB, bringing them in line with the latest charging standards with A and C ports and a maximum of 3.5A.

Available colour solutions

	Form	Flank	'NF	Deep	Surface	Italian standard	Italian USB A/C
	Frames		Plates			Front cover*	
Raw plastic	-	-	-	-	-	•	•
Plastic	•	•	•	•	-	•	•
Metal	•	•	•	•	•	•	•
Metal HT	-	-	-	•	•	•	•
Fenix NTM®	-	-	•	•	•	•	•

* The metal or Fenix NTM® colour effect is achieved by painting
For more information see page 214

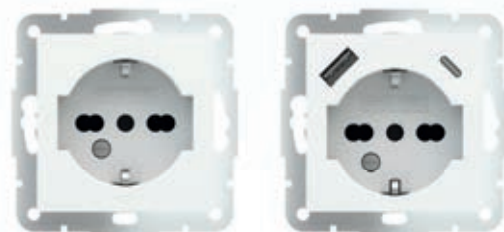

FORM
FLANK
'NF



DEEP

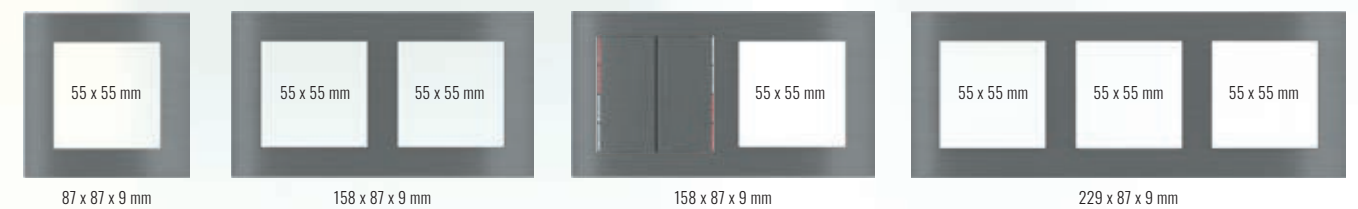

SURFACE

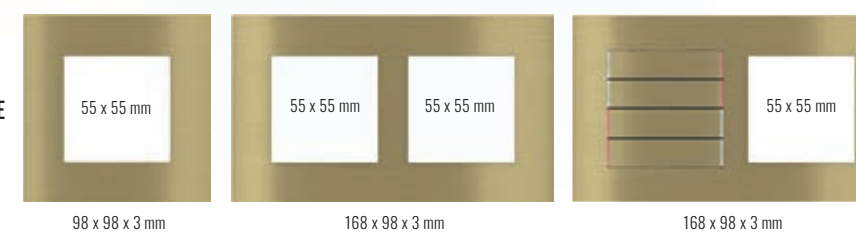



Power socket Schuko Version (standard and USB A-C)

WALL-MOUNT DEVICES

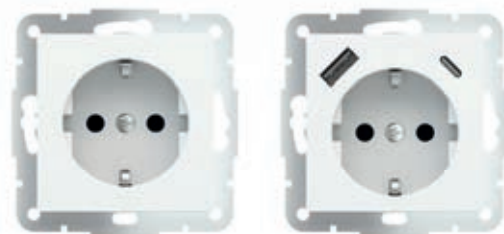

The new Ekinex Schuko standard sockets are available in versions with or without USB, bringing them in line with the latest charging standards with A and C ports and a maximum of 3.5A.

Available colour solutions

	Form	Flank	'NF	Deep	Surface	Schuko standard	Schuko USB A/C
	Frames		Plates		Front cover*		
Raw plastic	-	-	-	-	-	•	•
Plastic	•	•	•	•	-	•	•
Metal	•	•	•	•	•	•	•
Metal HT	-	-	-	•	•	•	•
Fenix NTM®	-	-	•	•	•	•	•

* The metal or Fenix NTM® colour effect is achieved by painting
For more information see page 214

FORM
FLANK
'NF



DEEP

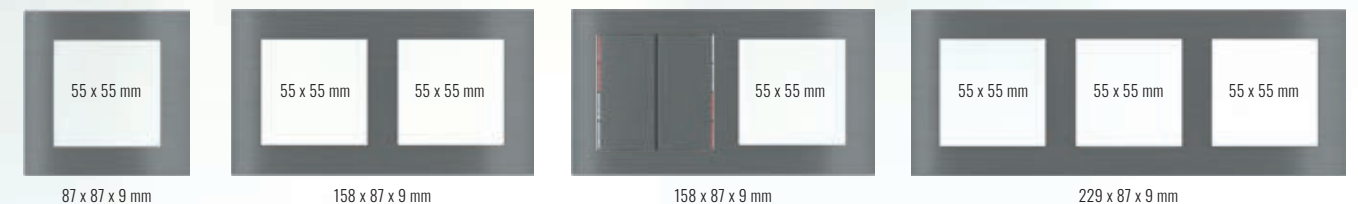

SURFACE

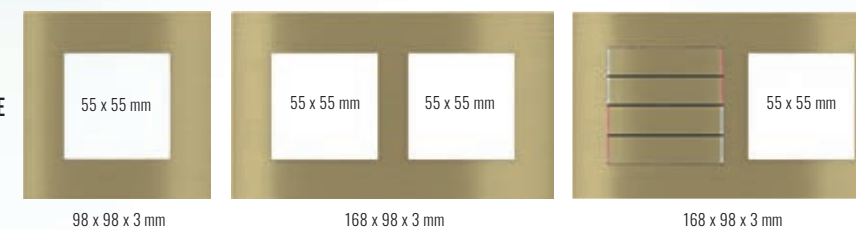



Power socket French Version (standard and USB A-C)

WALL-MOUNT DEVICES



The new Ekinex French standard sockets (Type E) are available in versions with or without USB, bringing them in line with the latest charging standards with A and C ports and a maximum of 3.5A.

Available colour solutions

	Form	Flank	'NF	Deep	Surface	French standard	French USB A/C
	Frames		Plates		Front cover*		
Raw plastic	-	-	-	-	-	•	•
Plastic	•	•	•	•	-	•	•
Metal	•	•	•	•	•	•	•
Metal HT	-	-	-	•	•	•	•
Fenix NTM®	-	-	•	•	•	•	•

* The metal or Fenix NTM® colour effect is achieved by painting
For more information see page 214

FORM
FLANK
'NF



80 x 80 x 8 mm

151 x 80 x 8 mm

151 x 80 x 8 mm

DEEP



87 x 87 x 9 mm

158 x 87 x 9 mm

158 x 87 x 9 mm

229 x 87 x 9 mm

SURFACE



98 x 98 x 3 mm

168 x 98 x 3 mm

168 x 98 x 3 mm

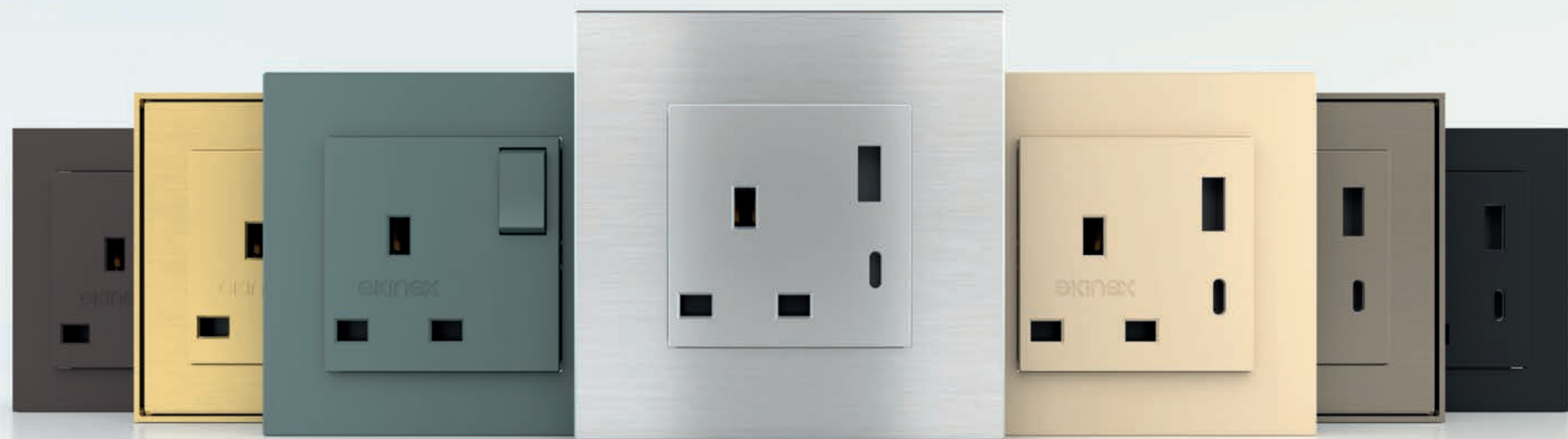

Power socket UK Version (standard and USB A-C)

WALL-MOUNT DEVICES



The new Ekinex UK standard sockets (British standard) are available in versions with or without USB, bringing them in line with the latest charging standards with A and C ports and a maximum of 3.5A.

Available colour solutions

	Form	Flank	'NF	Deep	Surface	UK standard	UK USB A/C
	Frames		Plates		Front cover*		
Raw plastic	-	-	-	-	-	•	•
Plastic	•	•	•	•	-	•	•
Metal	•	•	•	•	•	•	•
Metal HT	-	-	-	•	•	•	•
Fenix NTM®	-	-	•	•	•	•	•

* The metal or Fenix NTM® colour effect is achieved by painting
For more information see page 214

FORM FLANK 'NF



DEEP

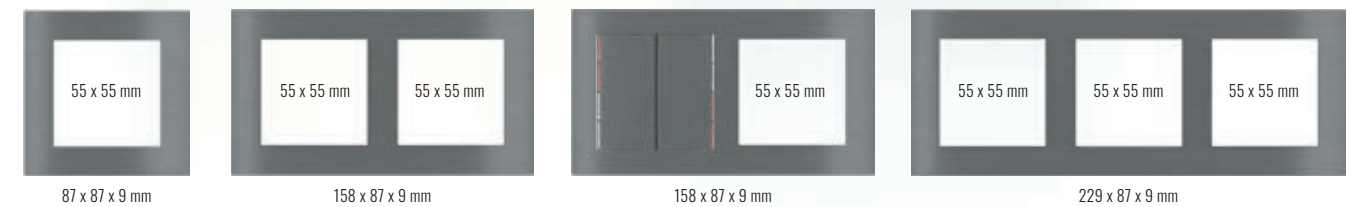

SURFACE

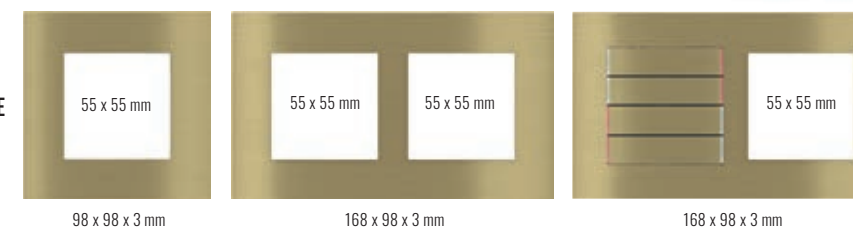

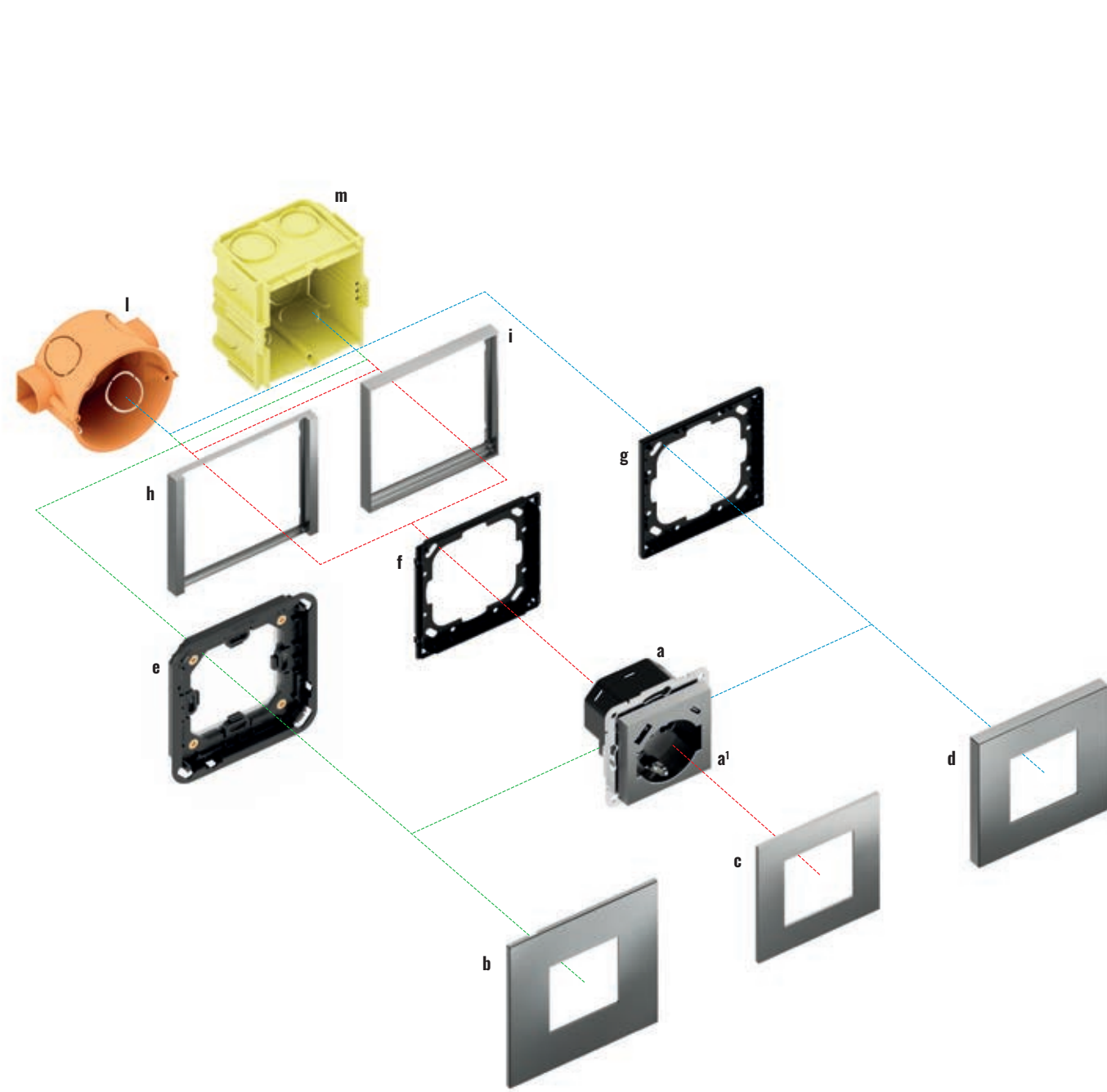

Single installation

Description	Code
a) Power socket (window 55 x 55 mm)	EK-PWS-IT or EK-PWS-IT-USB
	EK-PWS-DE or EK-PWS-DE-USB
	EK-PWS-FR or EK-PWS-FR-USB
a1) Front cover	EK-PWS-UK or EK-PWS-UK-USB
	EK-PSC-IT or EK-PSC-IT-USB
	EK-PSC-DE or EK-PSC-DE-USB
b) Surface square plate*	EK-PSC-FR or EK-PSC-FR-USB
	EK-PWS-UK or EK-PWS-UK-USB
c) Square plate*	EK-SQG-...
	EK-PQG-...

Description	Code
d) Deep square plate*	EK-DQG-...
e) Adapter for square Surface plate	EK-TAS-Q-W or EK-TAS-Q-N
f) Adapter for square plate Form or Flank frames	EK-TAQE-1
g) Adapter for square plate 'NF' and Deep version	EK-TAQE-1-NF
h) Square frame of Flank version	EK-FLQ-...
i) Square frame of Form version	EK-FOQ-...
l) Round built-in box	not delivered by Ekinex®
m) Square built-in box	not delivered by Ekinex®
*) 55 x 55 mm window	

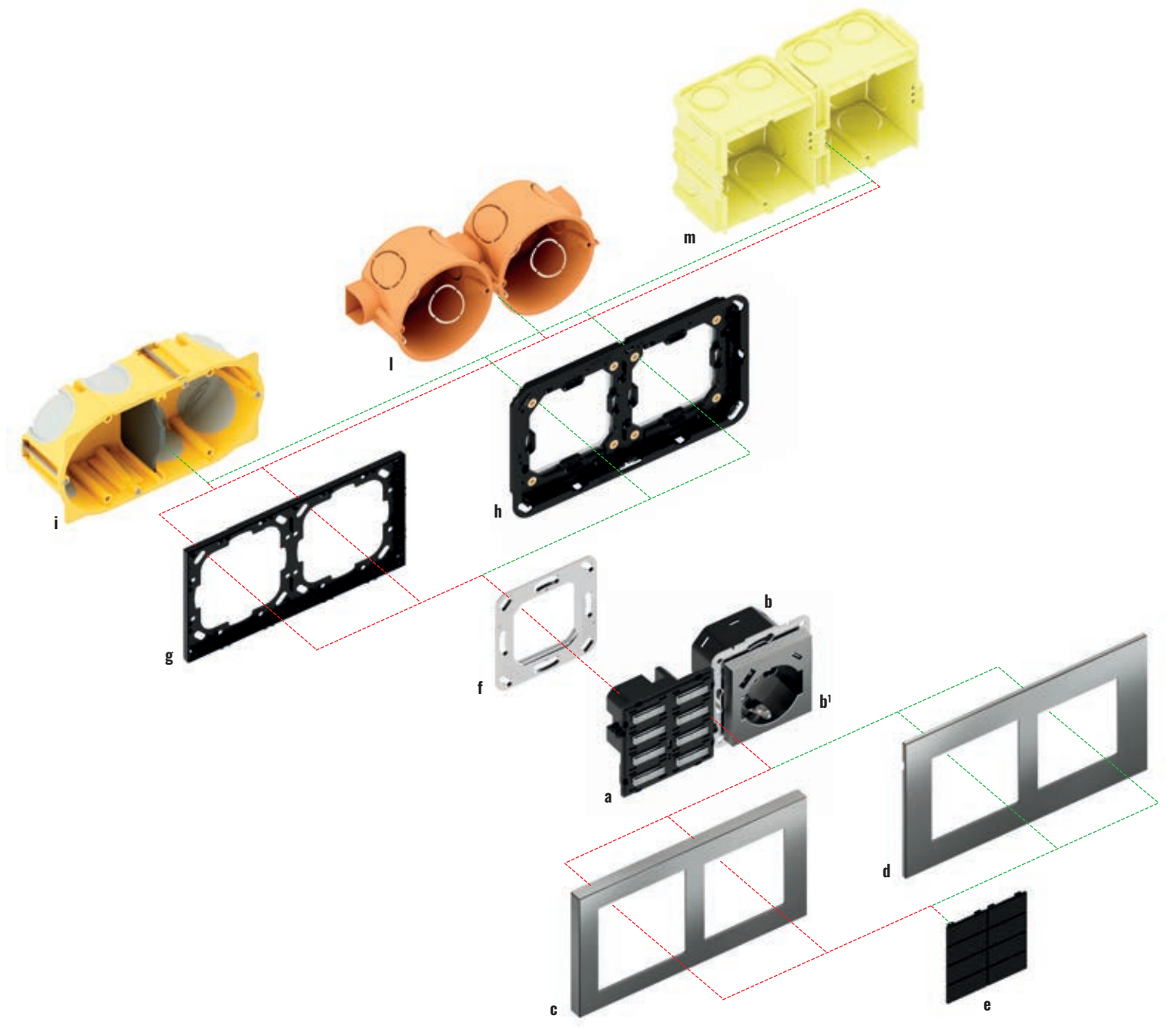

Double installation with centre distance 71 mm (20venti series)

Description	Code
a) Pushbutton 20venti series	EK-EZE-TP-...
b) Power socket (window 55 x 55 mm)	EK-PWS-IT or EK-PWS-IT-USB
	EK-PWS-DE or EK-PWS-DE-USB
	EK-PWS-FR or EK-PWS-FR-USB
	EK-PWS-UK or EK-PWS-UK-USB
	EK-PSC-IT or EK-PSC-IT-USB
	EK-PSC-DE or EK-PSC-DE-USB
b1) Front cover	EK-PSC-FR or EK-PSC-FR-USB
	EK-PWS-UK or EK-PWS-UK-USB
	EK-D2G-...
c) Deep double plate*	EK-D2G-...

Description	Code
d) Surface double plate*	EK-S2G-...
e) Horizontal rectangular keys (8)	EK-T4R-20-...
f) Metal mounting support	EK-SMQ-71-1
g) Double adapter for frame-free installation	EK-A71E-1-NF
h) Double adapter for Surface double plate	EK-TAS-D-W or EK-TAS-D-N
i) Double box for mobile walls	not delivered by Ekinex®
j) Single boxes for masonry walls	not delivered by Ekinex®
m) Single boxes for masonry walls	not delivered by Ekinex®
*) 60 x 60 mm + 55 x 55 mm window	

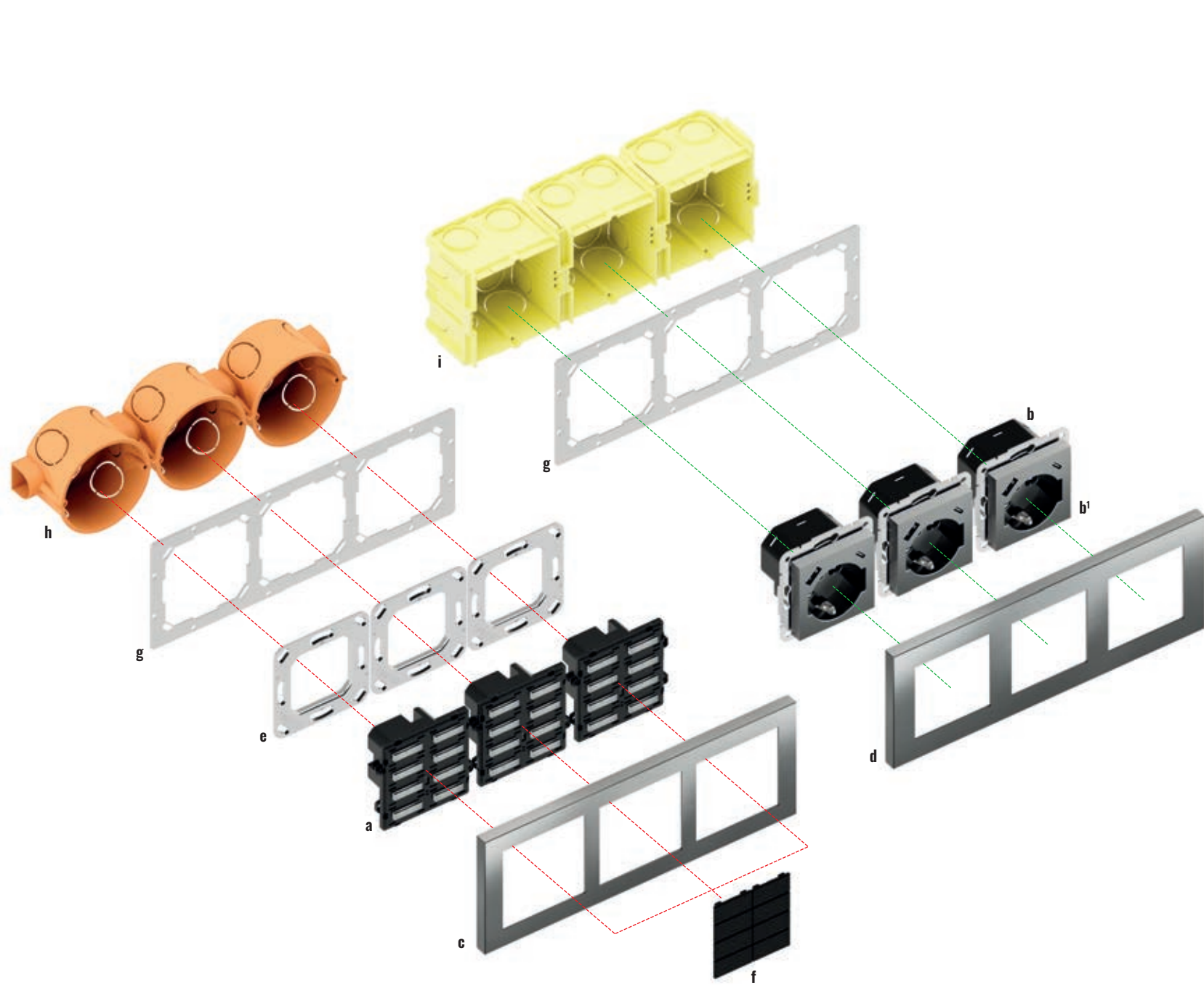

Triple installation with centre distance 71 mm (20venti series)

Description	Code
a) Pushbutton 20venti series	EK-E2E-TP-... EK-PWS-IT or EK-PWS-IT-USB EK-PWS-DE or EK-PWS-DE-USB EK-PWS-FR or EK-PWS-FR-USB EK-PWS-UK or EK-PWS-UK-USB
b) Power socket (window 55 x 55 mm)	EK-PSC-IT or EK-PSC-IT-USB EK-PSC-DE or EK-PSC-DE-USB EK-PSC-FR or EK-PSC-FR-USB EK-PWS-UK or EK-PWS-UK-USB
b1) Front cover	EK-PSC-DE or EK-PSC-DE-USB EK-PSC-FR or EK-PSC-FR-USB EK-PWS-UK or EK-PWS-UK-USB

Description	Code
c) Deep triple plate*	EK-D3S-...
d) Deep triple plate**	EK-D3P-...
e) Metal mounting support	EK-SMQ-71-1
f) Horizontal rectangular keys (8)	EK-T4R-20-...
g) Triple plate adapter - Deep version	EK-B71-1-NF
h) Single boxes for masonry walls	not delivered by Ekinex®

*) 60 x 60 mm window **) 55 x 55 mm window

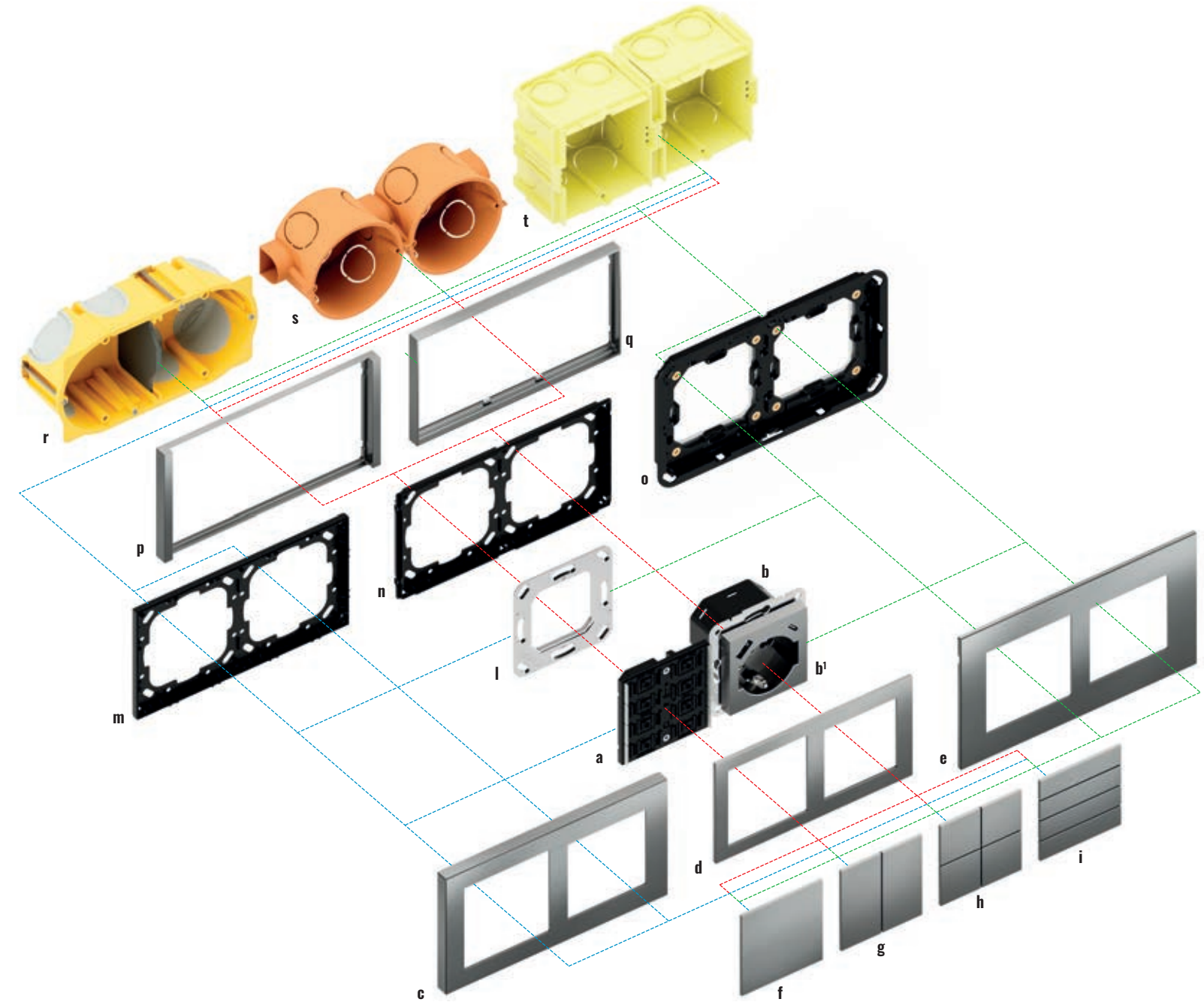

Double installation with centre distance 71 mm (71 series)

Description	Code
a) Pushbutton 71 series	EK-E13-TP-... o EK-E23-TP-... EK-PWS-IT or EK-PWS-IT-USB EK-PWS-DE or EK-PWS-DE-USB EK-PWS-FR or EK-PWS-FR-USB EK-PWS-UK or EK-PWS-UK-USB
b) Power socket (window 55 x 55 mm)	EK-PSC-IT or EK-PSC-IT-USB EK-PSC-DE or EK-PSC-DE-USB EK-PSC-FR or EK-PSC-FR-USB EK-PWS-UK or EK-PWS-UK-USB
b1) Front cover	EK-PSC-DE or EK-PSC-DE-USB EK-PSC-FR or EK-PSC-FR-USB EK-PWS-UK or EK-PWS-UK-USB
c) Deep double plate	EK-D2G-...
d) Double plate	EK-P2G-...
e) Surface double plate	EK-S2G-...
g) Rectangular vertical rockers (2)	EK-T2R-...

Description	Code
h) Square rockers (4)	EK-T4Q-...
f) Square rocker (1)	EK-T1Q-...
i) Rectangular horizontal rockers (4)	EK-T4R-...
l) Metal mounting support	EK-SMQ-71-1
m) Double adapter for frame-free installation	EK-A71E-1-NF
n) Adapter for double plate with a Form or Flank frame	EK-A71E
o) Double adapter for Surface double plate	EK-TAS-D-W or EK-TAS-D-N
p) Flank version double frame	EK-FL2-...
q) Form version double frame	EK-F02-...
r) Double box for mobile walls	not delivered by Ekinex®
s) Single boxes for masonry walls	not delivered by Ekinex®
t) Single boxes for masonry walls	not delivered by Ekinex®

*) 60 x 60 mm + 55 x 55 mm window

Electrical and USB power sockets

WALL-MOUNT DEVICES

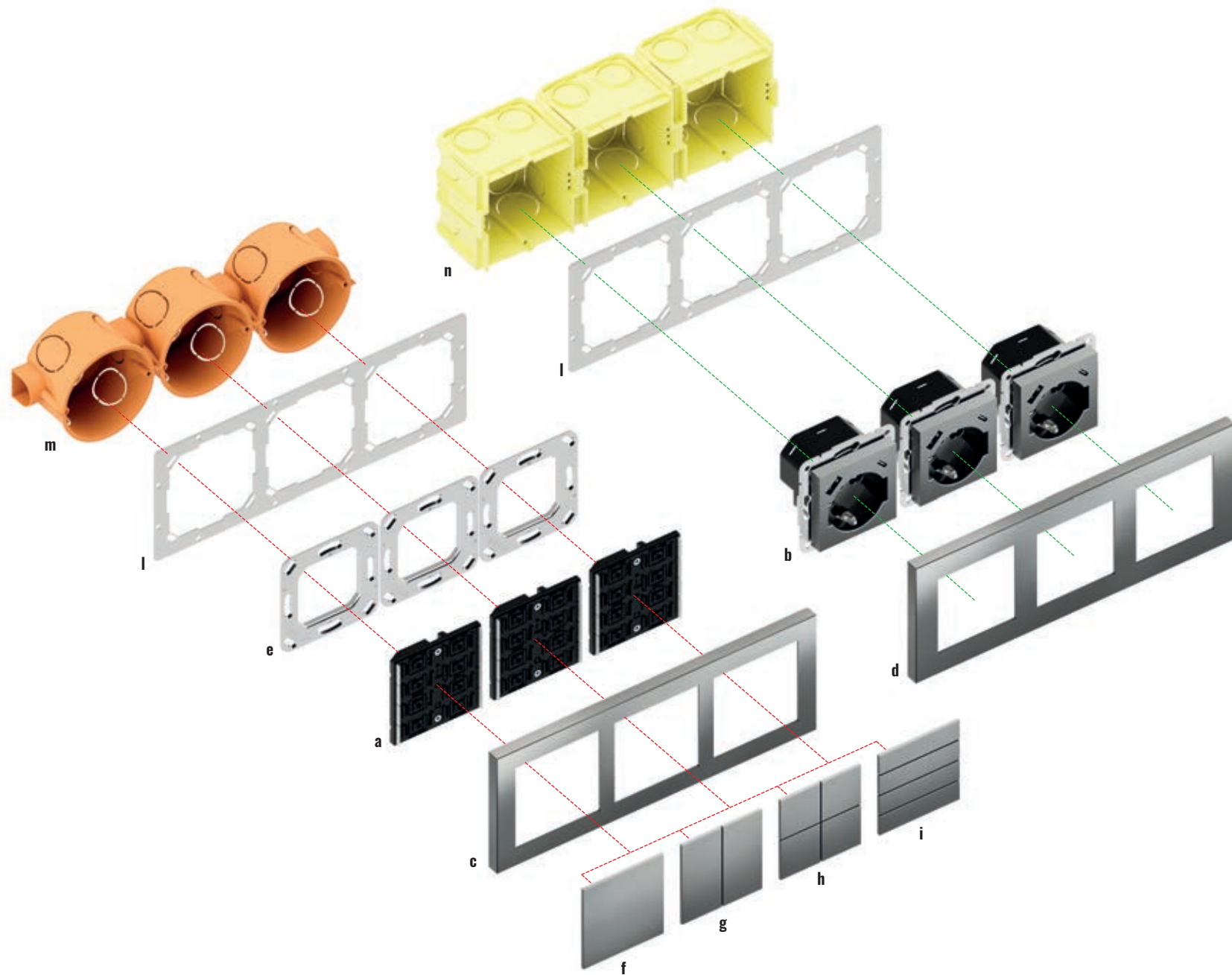

Triple installation with centre distance 71 mm (71 series)

Description	Code
a) Pushbutton 71 series	EK-E13-TP-... o EK-E23-TP-...
b) Power socket (window 55 x 55 mm)	EK-PWS-IT or EK-PWS-IT-USB
	EK-PWS-DE or EK-PWS-DE-USB
	EK-PWS-FR or EK-PWS-FR-USB
	EK-PWS-UK or EK-PWS-UK-USB
b1) Front cover	EK-PSC-IT or EK-PSC-IT-USB
	EK-PSC-DE or EK-PSC-DE-USB
	EK-PSC-FR or EK-PSC-FR-USB
c) Deep triple plate 71 series	EK-PWS-UK or EK-PWS-UK-USB
	EK-D3S-...

Description	Code
d) Deep triple plate 71 series	EK-D3P-...
e) Metal mounting support	EK-SMQ-71-1
f) Square rocker (1)	EK-T1Q-...
g) Rectangular vertical rockers (2)	EK-T2R-...
h) Square rockers (4)	EK-T4Q-...
i) Rectangular horizontal rockers (4)	EK-T4R-...
j) Triple plate adapter - Deep version*	EK-B71-1-NF
m) Single boxes for masonry walls	not delivered by Ekinex®
n) Single boxes for masonry walls	not delivered by Ekinex®

*) 60 x 60 mm window **) 55 x 55 mm window



Ekinex has paid particular attention to this detail with a special painting process that allows the socket to be colour matched to the other wall elements in its range. The inclusion of a USB output responds to the increasingly pressing need to connect to numerous devices for home or work use.

Essential: this is the most suitable adjective to describe the electrical socket. From the first one invented in America by Hubbel in 1904 to the German-made Schuko dated 1926, the socket has come down to us as the silent player in our electrical systems. Ekinex has given them a new lease of life with a colourful edition that matches keyboards and touch panels. The need to connect to the electricity network has increased in recent years: the list of devices that require a power supply is virtually endless. Ekinex electrical sockets come to your rescue with an extensive range for the Italian and international markets. Ekinex electric sockets are also equipped with USB type A and C ports and can be used to recharge all electronic devices in homes and offices. The many colours are in perfect family feeling with the FF, 71, 20venti and Signum series and can be combined with Fenix NTM®, metal, Metal HT and plastic finishes.



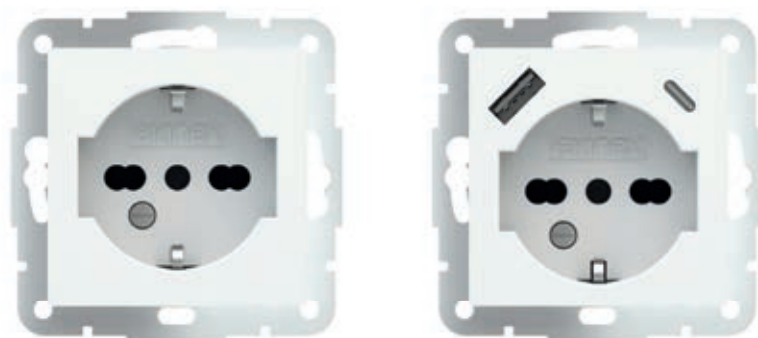

Power socket and USB A-C Italian version

WALL-MOUNT DEVICES

Description

The Ekinex model EK-PWS-IT-USB and EK-PWS-IT universal Italian standard sockets are 2P+T 16 A universal type devices for wall installation, for 2P 2.5 A europlugs, 2P and 2P + E 10 A and 16 A Italian standard plugs, 2P+T 16 A German standard plugs, for powering household appliances. The EK-PWS-IT-USB model is equipped with a USB power unit, both type-A and type-C, for charging mobile phones and in general all electronic devices that can be recharged via USB sockets of the same type. Charging of two devices at the same time is allowed.

Main features

- Connection of home devices with AC 250 V ~ voltage
- Contacts protected by shutters
- Mounting on a round or square wall box
- Terminals for cables with section up to 2.5 mm²
- USB Type-A and Type-C ports for charging electronic devices such as smartphones, tablets, etc. (only for EK-PWS-IT-USB)

Technical data

- Max. rated input voltage: AC 250 V ~
- Max rated input current: 16 A
- Network frequency: 50/60 Hz
- USB output voltage (only for EK-PWS-IT-USB): DC 5 V
- USB output current (only for EK-PWS-IT-USB): 3.4 A
- Standby power (only for EK-PWS-IT-USB): ≤ 50mW
- Energy efficiency (only for EK-PWS-IT-USB): 83%
- Operating temperature: -10 ... +40 ° C (indoor use)
- Storage / transport temperature: -20 ... +50 ° C
- Protection degree : IP 20
- Safety class 2 (double insulation)
- Connection type: solid or stranded cable with 1.5 ... 2.5 mm² section
- Connection type: screw
- Mounting depth: min. 40 mm
- Plastic housing
- Dimensions: 70 x 70 x 44 mm (LxHxP)

Delivery

A pair of screws for installation.

Accessories

- The following accessories are available for completion and must be ordered separately:
- square and double frame Form or Flank version
 - square, double and triple plate with 55 x 55 mm window
 - a plastic adapter

Dimensions [mm]

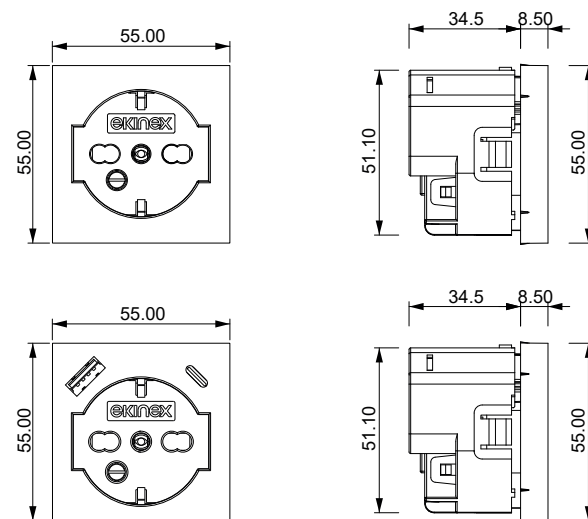

Order information

Code	Type	Code	Type
EK-PWS-IT	power socket - italian	EK-PWS-IT-USB	power socket - italian USB
EK-PSC-IT	rough white cover	EK-PSC-IT-USB	rough white cover
EK-PSC-IT-...	painted cover	EK-PSC-IT-USB-...	painted cover



Documentation

For more information see the technical documentation, download from www.ekinex.com

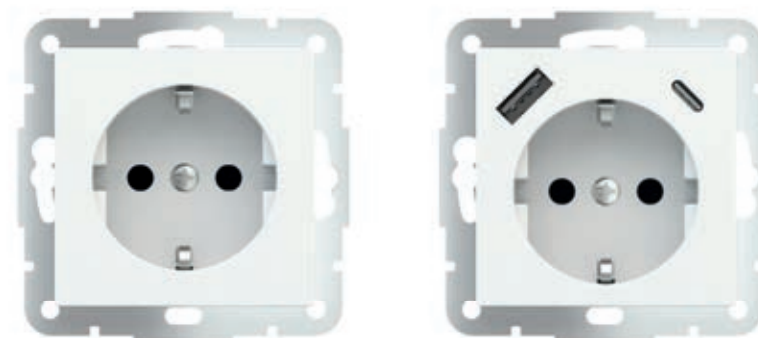

Power socket and USB A-C Schuko version

WALL-MOUNT DEVICES

Description

The Ekinex model EK-PWS-DE-USB and EK-PWS-DE Schuko® sockets (German standard) are 2P + T 16 A type wall installation devices, for powering household appliances. The EK-PWS-DE-USB model is equipped with a USB power unit, both type-A and type-C, for charging mobile phones and in general all electronic devices that can be recharged via USB sockets of the same type. Charging of two devices at the same time is allowed.

Main features

- Connection of home devices with AC 250 V ~ voltage
- Contacts protected by shutters
- Mounting on a round or square wall box
- Terminals for cables with section up to 2.5 mm²
- USB Type-A and Type-C ports for charging electronic devices such as smartphones, tablets, etc. (only for EK-PWS-DE-USB)

Technical data

- Max. rated input voltage: AC 250 V ~
- Max rated input current: 16 A
- Network frequency: 50/60 Hz
- USB output voltage (only for EK-PWS-DE-USB): DC 5 V
- USB output current (only for EK-PWS-DE-USB): 3.4 A
- Standby power (only for EK-PWS-DE-USB): ≤ 50mW
- Energy efficiency (only for EK-PWS-DE-USB): 83%
- Operating temperature: -10 ... +40 ° C (indoor use)
- Storage / transport temperature: -20 ... +50 ° C
- Protection degree : IP 20
- Safety class 2 (double insulation)
- Connection type: solid or stranded cable with 1.5 ... 2.5 mm² section
- Connection type: screw
- Mounting depth: min. 40 mm
- Plastic housing
- Dimensions: 70 x 70 x 44 mm (LxHxP)
- Certifications: BS 1363 Pt 2: 2010

Delivery

A pair of screws for installation.

Accessories

- The following accessories are available for completion and must be ordered separately:
- square and double frame Form or Flank version
 - square, double and triple plate with 55 x 55 mm window
 - a plastic adapter

Dimensions [mm]

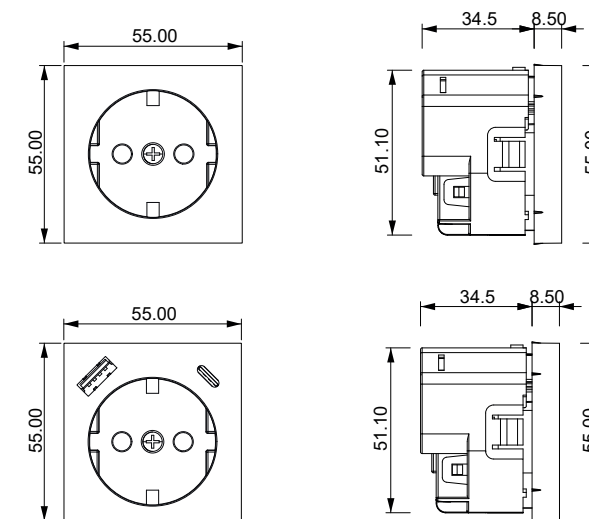

Order information

Code	Type	Code	Type
EK-PWS-DE	power socket - Schuko	EK-PWS-DE-USB	power socket - Schuko USB
EK-PSC-DE	rough white cover	EK-PSC-DE-USB	rough white cover
EK-PSC-DE-...	painted cover	EK-PSC-DE-USB-...	painted cover



Documentation

For more information see the technical documentation, download from www.ekinex.com



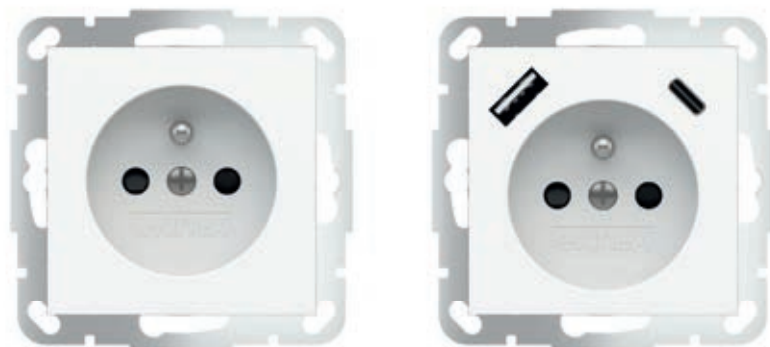

Power socket and USB A-C French version

WALL-MOUNT DEVICES

Description

The Ekinex EK-PWS-FR-USB and EK-PWS-FR French/Belgian standard sockets are E-type wall-mounted devices for supplying power to household appliances up to 16 A 250 V ~. The EK-PWS-FR-USB is equipped with a USB power supply unit, both type-A and type-C, for charging mobile phones and generally all electronic devices that can be charged via USB sockets of the same type. Charging of two devices at the same time is allowed.

Main features

- Connection of home devices with AC 250 V ~ voltage
- Contacts protected by shutters
- Mounting on a round or square wall box
- Terminals for cables with section up to 2.5 mm²
- USB Type-A and Type-C ports for charging electronic devices such as smartphones, tablets, etc. (only for EK-PWS-FR-USB)

Technical data

- Max. rated input voltage: AC 250 V ~
- Max rated input current: 16 A
- Network frequency: 50/60 Hz
- USB output voltage (only for EK-PWS-FR-USB): DC 5 V
- USB output current (only for EK-PWS-FR-USB): 3.4 A
- Standby power (only for EK-PWS-FR-USB): ≤ 50mW
- Energy efficiency (only for EK-PWS-FR-USB): 83%
- Operating temperature: -10 ... +40 °C (indoor use)
- Storage / transport temperature: -20 ... +50 °C
- Protection degree : IP 20
- Safety class 2 (double insulation)
- Connection type: solid or stranded cable with 1.5 ... 2.5 mm² section
- Connection type: screw
- Mounting depth: min. 40 mm
- Plastic housing
- Dimensions: 70 x 70 x 44 mm (LxHxD)

Delivery

A pair of screws for installation.

Accessories

- The following accessories are available for completion and must be ordered separately:
- square and double frame Form or Flank version
 - square, double and triple plate with 55 x 55 mm window
 - a plastic adapter

Dimensions [mm]

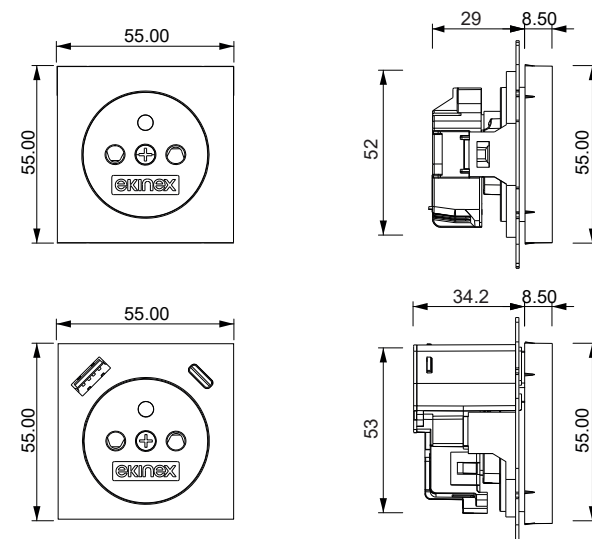

Order information

Code	Type	Code	Type
EK-PWS-FR	power socket - french	EK-PWS-FR-USB	power socket - french USB
EK-PSC-FR	rough white cover	EK-PSC-FR-USB	rough white cover
EK-PSC-FR-...	painted cover	EK-PSC-FR-USB-...	painted cover



Documentation

For more information see the technical documentation, download from www.ekinex.com



Power socket and USB A-C UK version

WALL-MOUNT DEVICES

Description

The Ekinex EK-PWS-UK-USB and EK-PWS-UK model UK (British standard) sockets are G-type 13 A wall-mounted devices for supplying power to household appliances. The EK-PWS-UK-USB is equipped with a USB power supply unit, both type A and type C (Fast charge), for charging mobile phones and in general all electronic devices that can be charged via USB sockets. Charging of two devices at the same time is allowed. The EK-PWS-UK is equipped with a double-pole switch for electrical disconnection.

Main features

- Connection of home devices with AC 250 V ~ voltage
- Contacts protected by shutters
- Mounting on a round or square wall box
- Terminals for cables with section up to 2.5 mm²
- USB Type-A and Type-C ports for charging electronic devices such as smartphones, tablets, etc. (only for EK-PWS-UK-USB)

Technical data

- Max. rated voltage: AC 250 V ~
- Max. rated current: 13 A
- Mains frequency: 50/60 Hz
- USB output voltage (only for EK-PWS-UK-USB) DC 5 V
- USB output current (EK-PWS-UK-USB only): 4 A (Fast charge)
- Standby power (EK-PWS-UK-USB only): ≤ 50mW
- Switch (EK-PWS-UK only): double pole
- Ambient temperature: -10... +40 °C (indoor use)
- Storage / transport temperature -20... +50 °C
- Degree of protection: IP 20
- Safety class 2 (double insulation)
- Type of connection: rigid or flexible cable with 1.5... 2.5 mm²
- Type of connection: screw
- Mounting depth: min. 40 mm
- Plastic cover
- Dimensions: 70 x 70 x 44 mm (WxHxD)
- Certifications: BS 1363 Pt 2: 2010

Delivery

A pair of screws for installation.

Accessories

- The following accessories are available for completion and must be ordered separately:
- square and double frame Form or Flank version
 - square, double and triple plate with 55 x 55 mm window
 - a plastic adapter

Dimensions [mm]

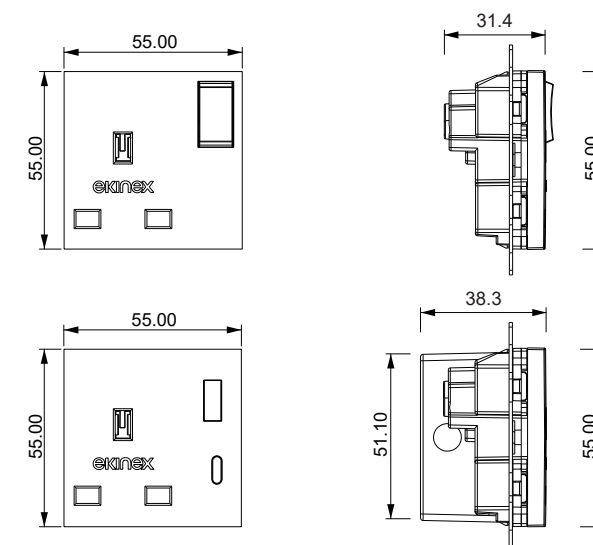

Order information

Code	Type	Code	Type
EK-PWS-UK	power socket - UK	EK-PWS-DE-USB	power socket - UK USB
EK-PSC-UK	rough white cover	EK-PSC-DE-USB	rough white cover
EK-PSC-UK-...	painted cover	EK-PSC-DE-USB-...	painted cover



Documentation

For more information see the technical documentation, download from www.ekinex.com



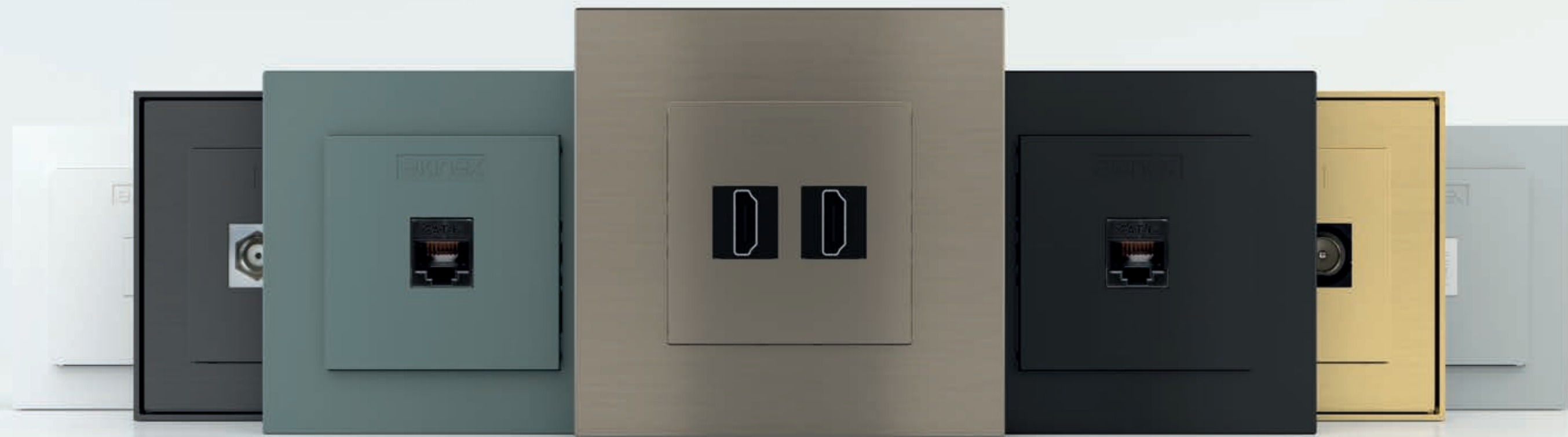

Keystone system

WALL-MOUNT DEVICES

The **Keystone system** is a versatile modular connection system that can be used for numerous applications. Ekinex presents various modules such as HDMI cables, RJ45 8/8 sockets, SAT/Antenna, etc. that can solve any connection requirement.

Available colour solutions

	Form	Flank	'NF	Deep	Surface	Keystone system
	Frames		Plates		Front cover*	
Raw plastic	-	-	-	-	-	•
Plastic	•	•	•	•	-	•
Metal	•	•	•	•	•	•
Metal HT	-	-	-	•	•	•
Fenix NTM®	-	-	•	•	•	•

* The metal or Fenix NTM® colour effect is achieved by painting
For more information see page 214

FORM FLANK 'NF



DEEP

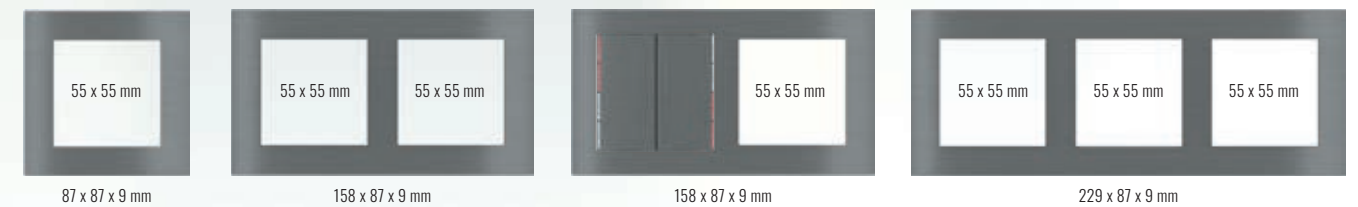

SURFACE

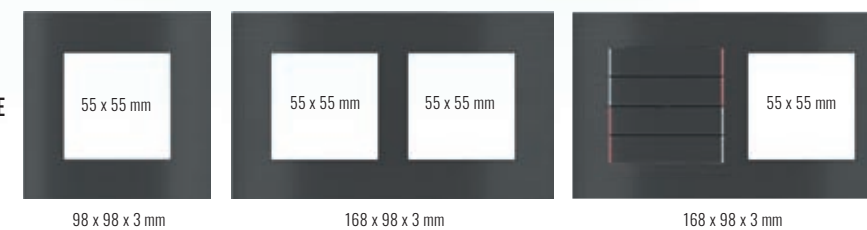

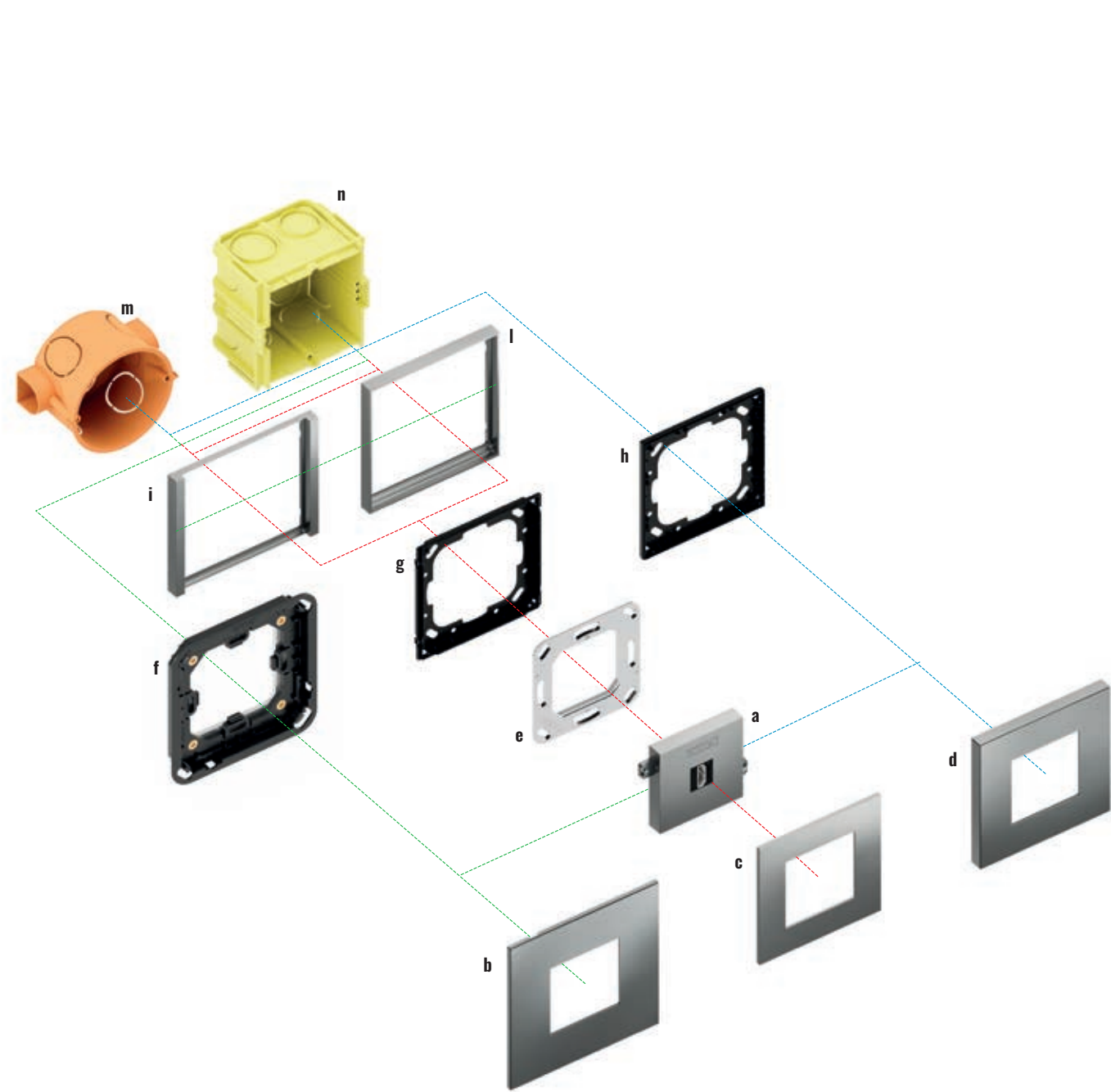

Single installation

Description	Code
a) Keystone system (55 x 55 mm module)	EK-KS_...
b) Surface square plate*	EK-SQG-...
c) Square plate*	EK-PQG-...
d) Deep square plate*	EK-DQG-...
e) Metal mounting support	EK-SMQ-71-1
f) Adapter for square Surface plate	EK-TAS-Q-W or EK-TAS-Q-N
g) Adapter for square plate Form or Flank frames	EK-TAQE-1

Description	Code
g) Adapter for square plate 'NF and Deep version	EK-TAQ-NF
h) Square frame of Flank version	EK-FLQ-...
i) Square frame of Form version	EK-FOQ-...
j) Round built-in box	not delivered by Ekinex®
m) Square built-in box	not delivered by Ekinex®
*) 55 x 55 mm window	

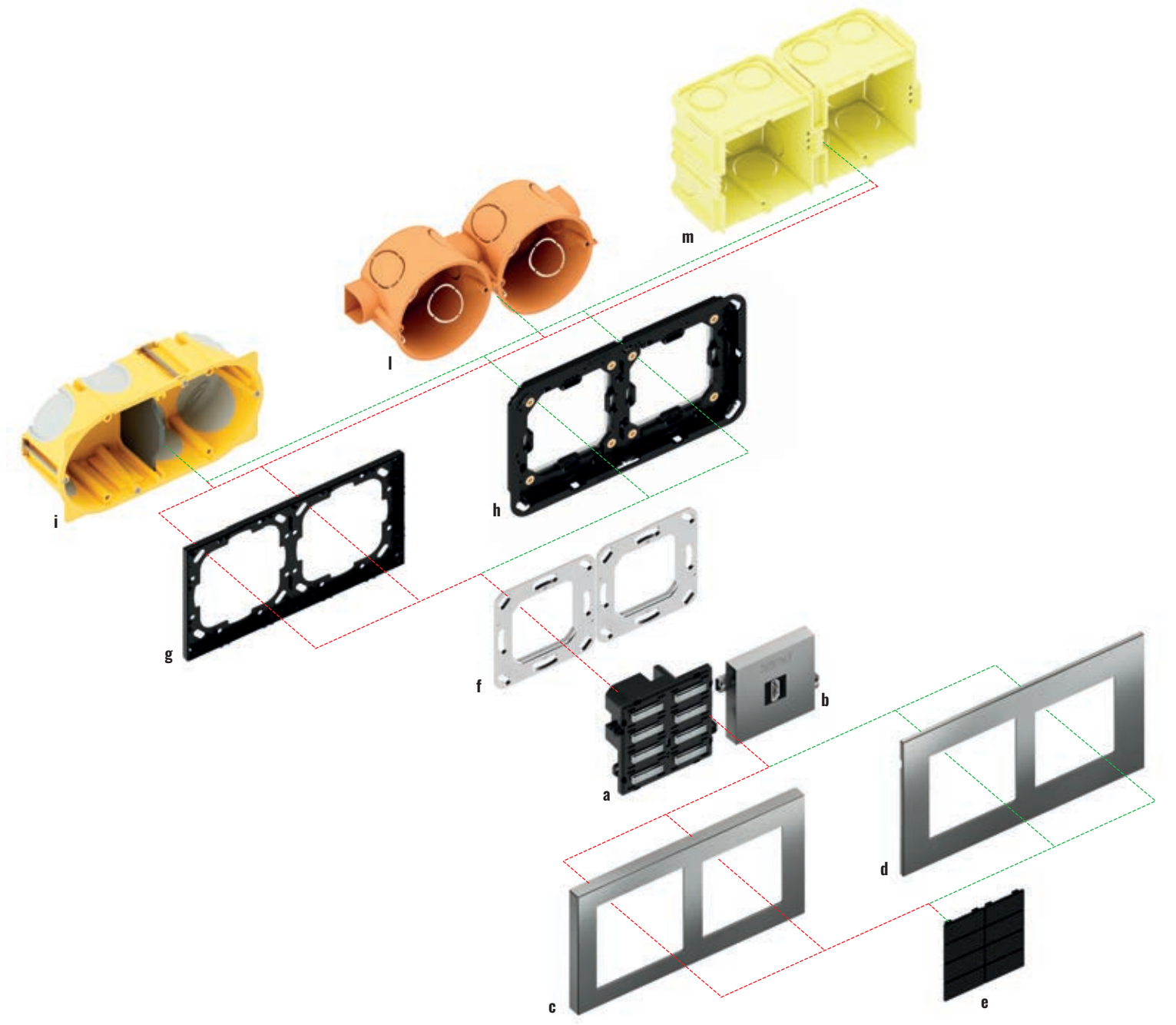

Double installation with centre distance 71 mm (20venti series)

Description	Code
a) 20venti pushbutton	EK-E2E-TP-...
b) Keystone system (55 x 55 mm module)	EK-KS_...
c) Deep double plate*	EK-D2G-...
d) Surface double plate*	EK-S2G-...
e) Horizontal rectangular keys (8)	EK-T4R-20-...
f) Metal mounting support	EK-SMQ-71-1

Description	Code
g) Double adapter for frame-free installation	EK-A71E-1-NF
h) Double adapter for Surface double plate	EK-TAS-D-W or EK-TAS-D-N
i) Double box for mobile walls	not delivered by Ekinex®
j) Single boxes for masonry walls	not delivered by Ekinex®
m) Single boxes for masonry walls	not delivered by Ekinex®
*) 60 x 60 mm + 55 x 55 mm window	

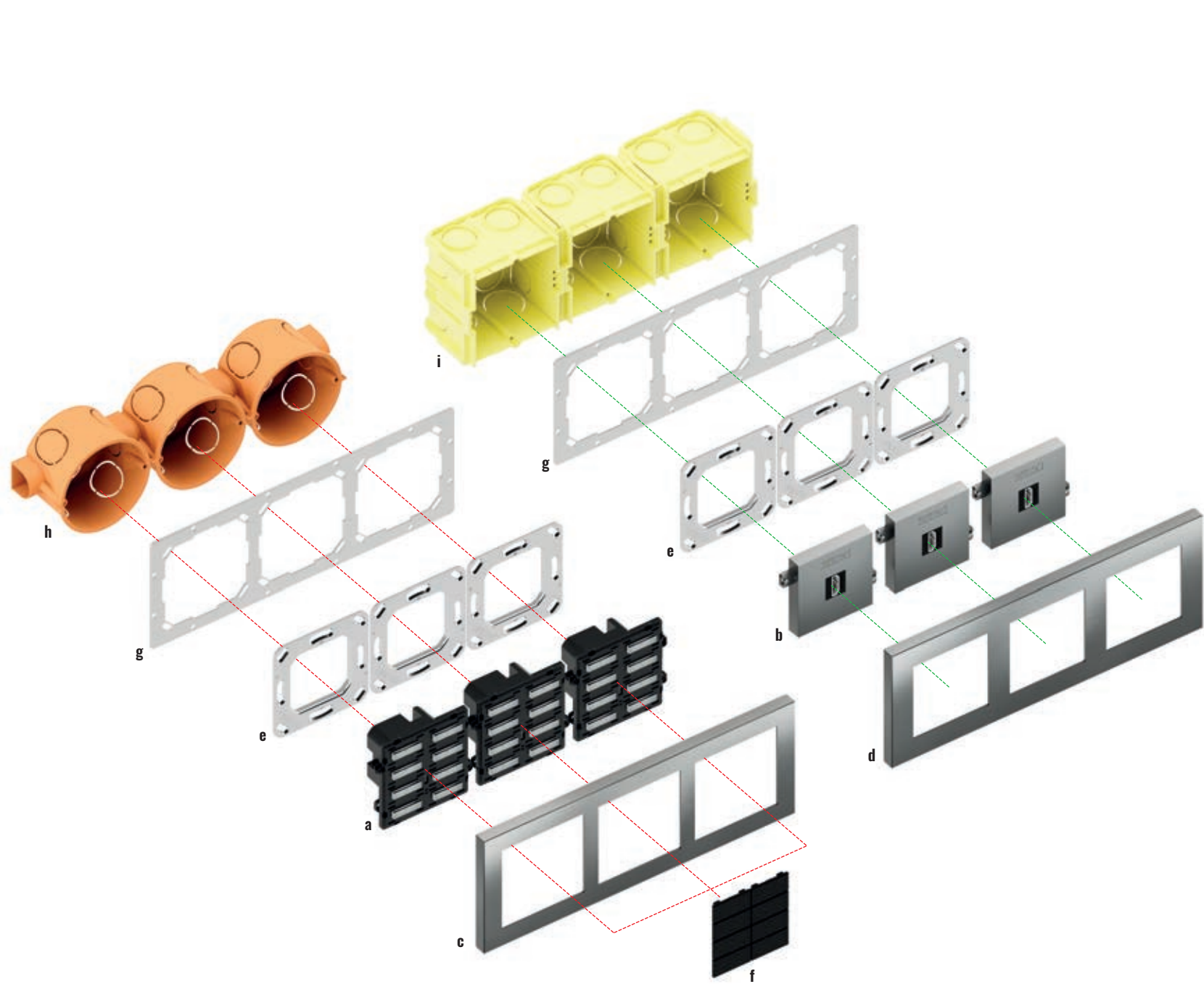

Triple installation with centre distance 71 mm (20venti series)

Description	Code
a) Pushbutton 20venti series	EK-E2E-TP-...
b) Keystone system (55 x 55 mm module)	EK-KS_-...
c) Deep triple plate*	EK-D3S-...
d) Deep triple plate**	EK-D3P-...
e) Metal mounting support	EK-SMQ-71-1
f) Horizontal rectangular keys (8)	EK-T4R-20-...

Description	Code
g) Triple plate adapter - Deep version	EK-B71-1-NF
h) Single boxes for masonry walls	not delivered by Ekinex®
i) Single boxes for masonry walls	not delivered by Ekinex®

*) 60 x 60 mm window **) 55 x 55 mm window

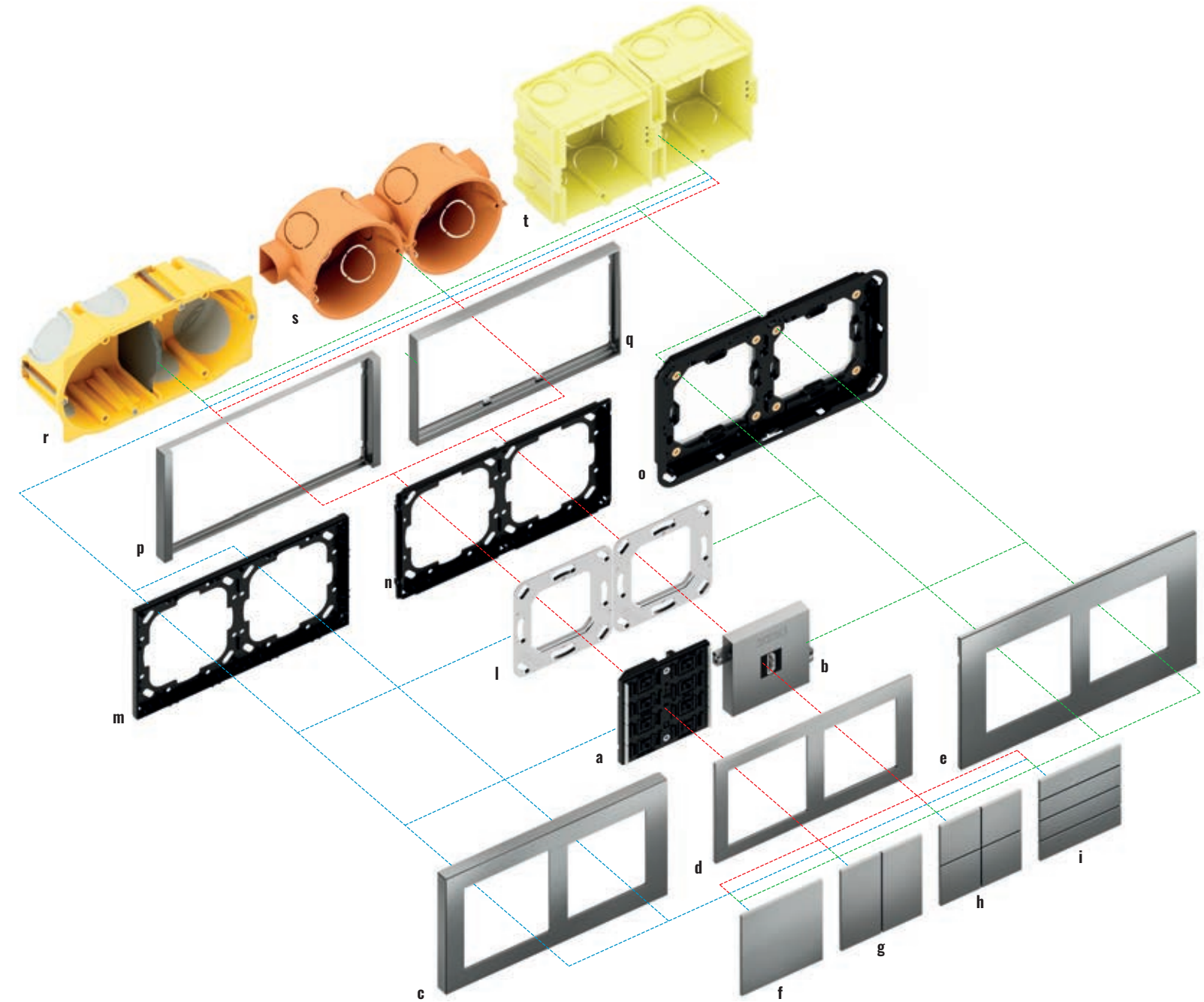

Double installation with centre distance 71 mm (71 series)

Description	Code
a) Pushbutton 71 series	EK-E13-TP-... o EK-E23-TP-...
b) Keystone system (55 x 55 mm module)	EK-KS_-...
c) Deep double plate	EK-D2G-...
d) Double plate	EK-P2G-...
e) Surface double plate	EK-S2G-...
f) Square rocker (1)	EK-T1Q-...
g) Rectangular vertical rockers (2)	EK-T2R-...
h) Square rockers (4)	EK-T4Q-...
i) Rectangular horizontal rockers (4)	EK-T4R-...
l) Metal mounting support	EK-SMQ-71-1

Description	Code
m) Double adapter for frame-free installation	EK-A71E-1-NF
n) Adapter for double plate with a Form or Flank frame	EK-A71E
o) Double adapter for Surface double plate	EK-TAS-D-...
p) Flank version double frame	EK-FL2-...
q) Form version double frame	EK-F02-...
r) Double box for mobile walls	not delivered by Ekinex®
s) Single boxes for masonry walls	not delivered by Ekinex®
t) Single boxes for masonry walls	not delivered by Ekinex®

*) 60 x 60 mm + 55 x 55 mm window

Keystone System

WALL-MOUNT DEVICES

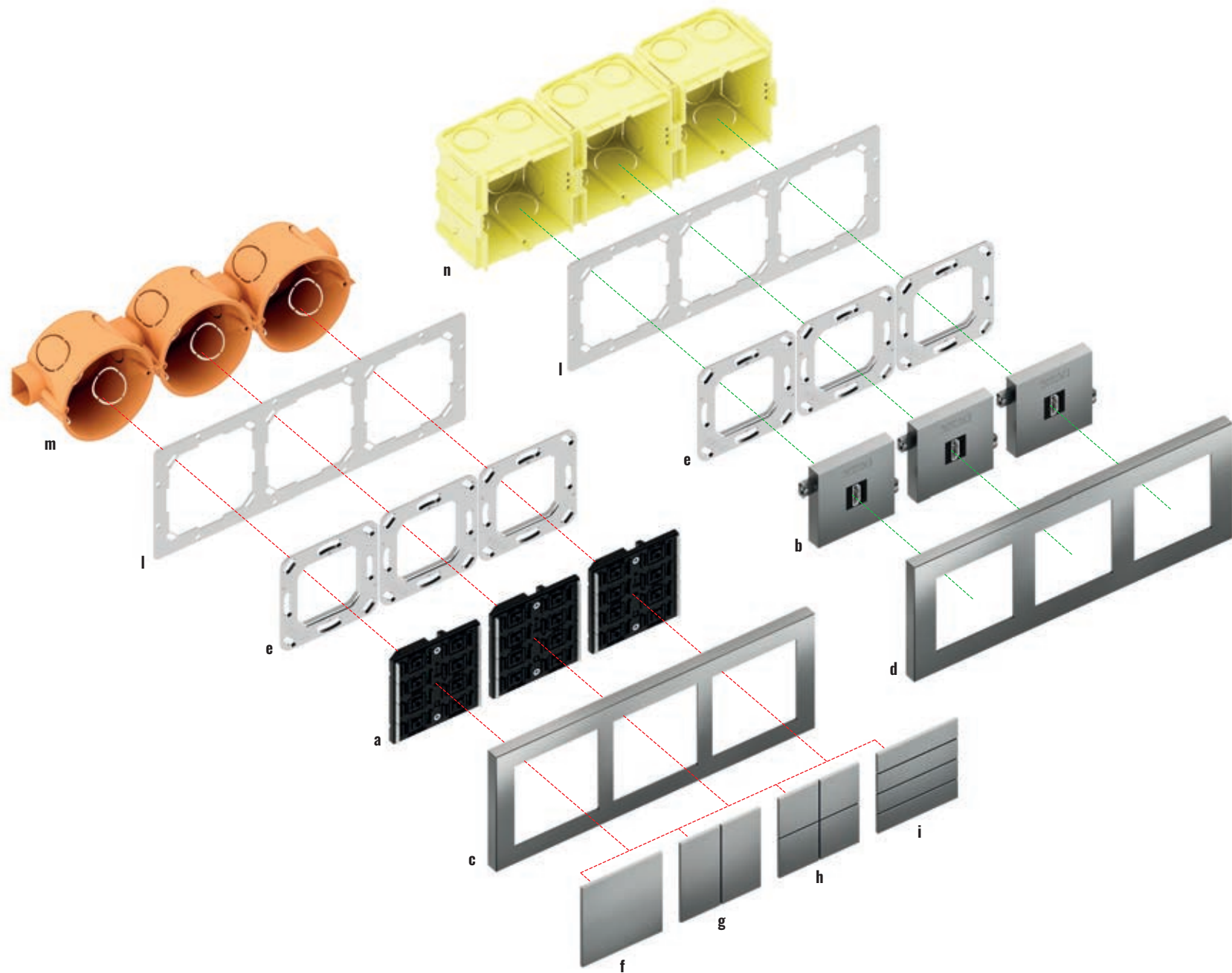

Keystone modules compatible with Ekinex civil series. Wide range of devices to integrate network systems, multimedia systems and antenna systems. The front covers can be declined in the various colours available, thanks to a special painting process that allows them to be chromatically matched to the other wall devices.

Keystone modules are compatible with Ekinex civil series and offer the possibility of numerous customizations, able to meet the most different needs. A wide range of devices is available to integrate network, multimedia and antenna systems. The standard dimensions allow an easy installation. They are completed with a square, double or triple plate with window dimension 55 x 55 mm, able to accommodate one or more modules. Covers are available in plastic material, in numerous color and finish variations. Plastic caps are available to cover unused spaces.

Triple installation with centre distance 71 mm (71 series)

Description	Code
a) Pushbutton 71 series	EK-E13-TP-... o EK-E23-TP-...
b) Keystone system (55 x 55 mm module)	EK-KS-...
c) Deep triple plate 71 series	EK-D3S-...
d) Deep triple plate 71 series	EK-D3P-...
e) Metal mounting support	EK-SMQ-71-1
f) Square rocker (1)	EK-T1Q-...
g) Rectangular vertical rockers (2)	EK-T2R-...

Description	Code
h) Square rockers (4)	EK-T4Q-...
i) Rectangular horizontal rockers (4)	EK-T4R-...
l) Triple plate adapter - Deep version*	EK-B71-1-NF
m) Single boxes for masonry walls	not delivered by Ekinex®
n) Single boxes for masonry walls	not delivered by Ekinex®

*) 60 x 60 mm window **) 55 x 55 mm window

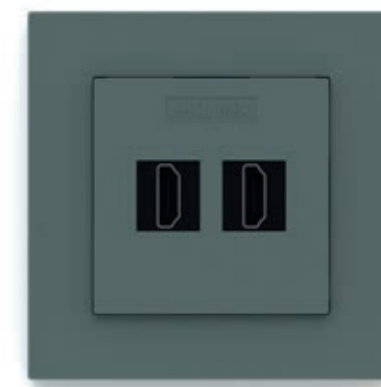

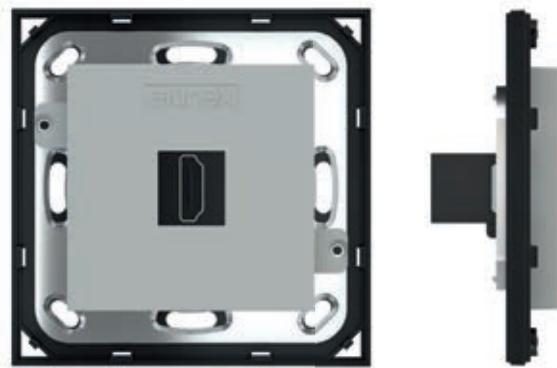

Keystone System

WALL-MOUNT DEVICES

Description

Keystone modules compatible with Ekinex civil series. Wide range of devices to integrate network systems, multimedia systems and antenna systems.

Main features

- Usage: indoor
- IP Protection: IP20
- Material: Plastic

Technical data

- Dimensions (WxDxH): approx. 29.7 x 21.9 x 17.4 mm
- Operating temperature -10° to +60°.
- Packaging temperature -40° to +70° C
- Permissible humidity 10 to 90
- Certificates: CE & RoHS

Delivery

Two pair of screws for installation.

Accessories

The following accessories are available to complete and to be ordered separately:

- Square and double frame Form or Flank version
- Square, double and triple plate with 55 x 55 mm window
- a plastic adapter
- a metal support for installation onto round or square mounting box (fixing holes 60 mm apart)

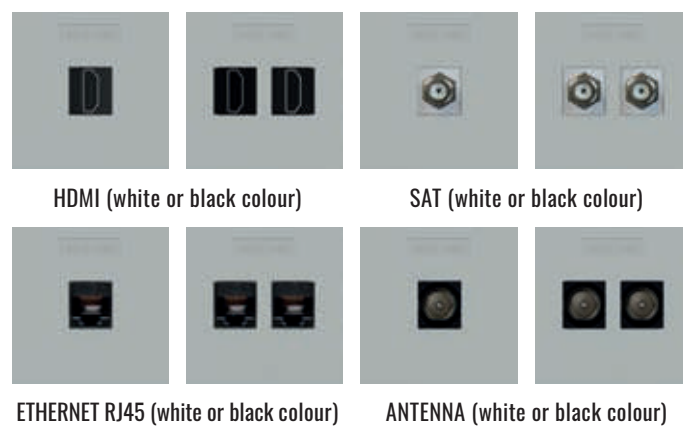

Dimensions [mm]

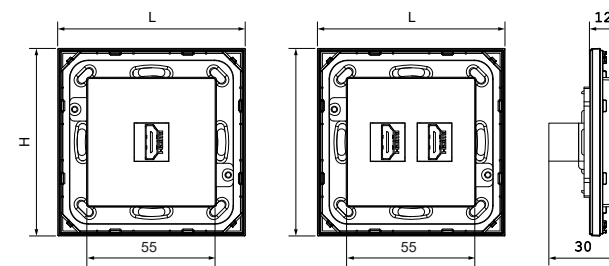

Mounting with frame: 81 x 77 (L x H)
Mounting without frame (NF): 80 x 80 (L x H)

Order information

Code	Type	Color	Code	Type	Color
EK-KSC-1K	1 connector cover	Raw White	EK-KSC-1K-...	1 connector cover	Painted
EK-KSC-2K	2 connectors cover	Raw White	EK-KSC-2K-...	2 connectors cover	Painted
EK-KSM-HDMI-WH	HDMI female/female connector	White	EK-KSM-RJ45-WH	RJ45 connector cat.6 UTP	White
EK-KSM-HDMI-BL		Black	EK-KSM-RJ45-BL		Black
EK-KSM-TVF-WH	TV-SAT coaxial socket F female connector	White	EK-KSM-TVM-WH	Coaxial TV socket IEC male connector	White
EK-KSM-TVF-BL		Black	EK-KSM-TVM-BL		Black
EK-KSM-PLUG-WH	Blind plug	White	EK-KSM-PLUG-BL	Blind plug	Black

Documentation

For more information see the technical documentation, download from www.ekinex.com





Accessories

WALL-MOUNT DEVICES

Ekinex has developed a series of accessories for the mounting of its KNX wall and panel mounting products such as: frames, rockers and plates, adapter frames, mounting brackets, templates, bus cables and clamps.

Available colour solutions

	Form	Flank	'NF	Deep	Surface	FF	71	20venti
	Frames		Plates			Rockers		
Plastic	•	•	•	•	-	•	•	•
Metal	•	•	•	•	•	•	•	-
Metal HT	-	-	-	•	•	•	•	-
Fenix NTM®	-	-	•	•	•	•	•	-

For more information see page 214



Rockers for pushbuttons 20venti series

WALL-MOUNT DEVICES

Description

Rockers for use as operation surface for pushbuttons of 20venti series. Rockers are available in several colour and material variations and are passive components.

Versions

- rectangular with 30 x 15 mm modularity

Main features

- In plastic material
- Snap-on mounting
- Customizable with symbols and text backlit by RGB LED

Order

Base-codes must be completed by adding extensions for material, colour and finishing (3 characters) plus symbols and text (3 characters).

Dimensions [mm]

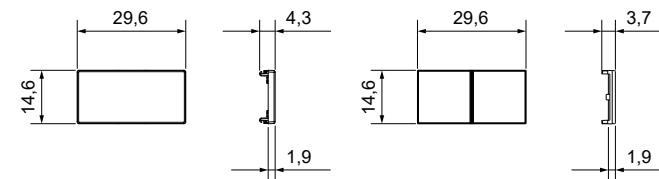

Order information

Code	Modularity * L x H [mm]	For use with	Package
EK-T4R-20-...	rectangular 30 x 15 symbol/text backlit RGB	pushbutton 20venti series	4 pcs.
EK-T4R-20-MA09	rectangular 30 x 15 status led backlit RGB		
EK-T2B-20-...	rectangular 30 x 15 for adjustments RGB		1 pcs.
EK-T8R-20-TR	rectangular 30 x 15 transparent		8 pcs.

*) The modularity indicated also takes into account the distance between the rockers and between rockers and light-guides and, therefore, differs slightly from the actual size of the single rockers

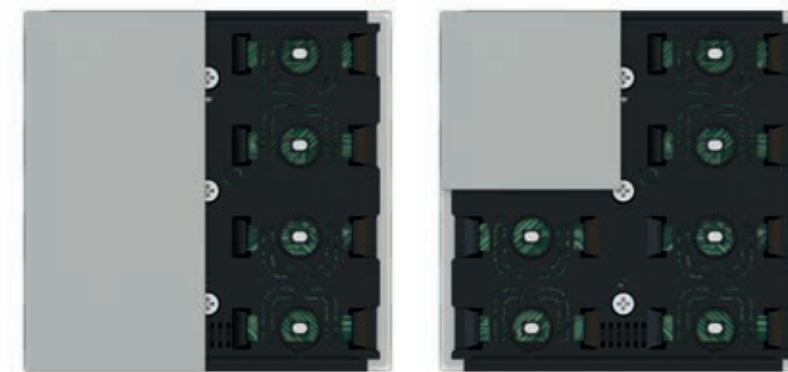

Rockers for 4-fold pushbuttons FF series

WALL-MOUNT DEVICES

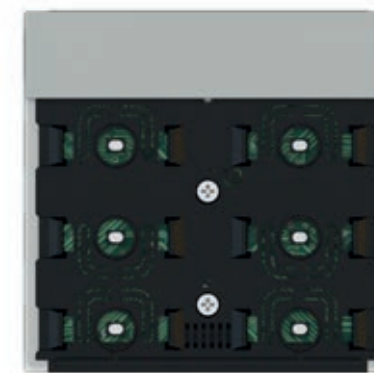

Description

Rockers for use as operation surface for 4-fold pushbuttons of FF series. They can perform two independent functions by acting on either its upper or lower zones (square and vertical rectangular versions) or on either its left or right zones (horizontal rectangular versions). Rockers are available in several colour and material variations and are passive components.

Versions

- square with 40 x 40 mm modularity
- horizontal rectangular with 80 x 20 mm modularity
- vertical rectangular with 40 x 80 mm modularity

Order information

Code	Modularity * L x H [mm]	For use with **	Package
EK-TQQ-...	square 40 x 40	4-fold pushbutton FF series	4 pcs.
EK-TRV-...	vertical rectangular 40 x 80		2 pcs.
EK-TRO-...	horizontal rectangular 80 x 20		4 pcs.

*) The modularity indicated also takes into account the distance between the rockers and between rockers and light guides and, therefore, differs slightly from the actual size of the single rockers
 **) The actual functioning as pushbutton with 2 or 4 channels depends on the configuration of the device parameters carried out with ETS



Main features

- In plastic material, aluminium, Metal HT or Fenix NTM®
- Snap-on mounting
- Customizable with symbols and text

Delivery

Delivery includes a tool for rockers removal.

Order

Base-codes must be completed by adding extensions for material, colour and finishing (3 characters) plus symbols and text (3 characters).

Dimensions [mm]

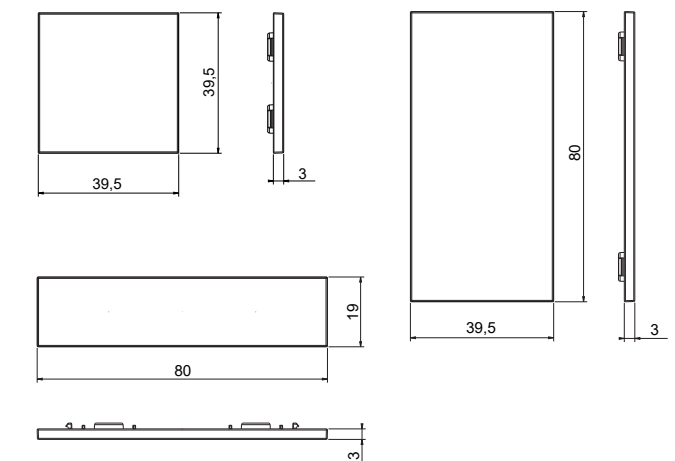



Rockers for 6-fold pushbuttons and Touch&See FF series

WALL-MOUNT DEVICES

Description

Rockers for use as operation surface for 6-fold pushbuttons and Touch&See with 2-fold pushbutton of FF series. They can perform two independent functions by pressing on either its upper or lower zones. Rockers are available in several colour and material variations and are passive components.

Versions

- square with 40 x 40 mm modularity

Main features

- In plastic material, aluminium, Metal HT or Fenix NTM®
- Snap-on mounting
- Customizable with symbols and text

Order information

Code	Modularity [mm]	For use with	Package
EK-TQQ-...	square 40 x 40	6-fold pushbutton of FF series Touch&See of FF series	4 pcs.



Delivery

Delivery includes a tool for rockers removal.

Order

Base-codes must be completed by adding extensions for material, colour and finishing (3 characters) plus symbols and text (3 characters).

Dimensions [mm]

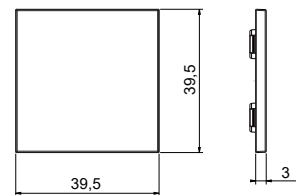

Set 2 rockers for room thermostats FF series

WALL-MOUNT DEVICES

Description

Set rockers for use as operation surface for room thermostats of FF series. They can perform two independent functions by acting on either its upper or lower zones. Rockers are available in several colour and material variations and are passive components.

Versions

- square with 40 x 40 mm modularity

Main features

- In plastic material, aluminium, Metal HT or Fenix NTM®
- Snap-on mounting
- Customized with symbols for room thermostat functions

Order information

Code	Modularity [mm]	For use with	Package.
EK-TQQ-...-EP2	square 40 x 40	room thermostats of FF series	2 pcs.



Delivery

Delivery includes a tool for rockers removal.

Order

Base-codes must be completed by adding extensions for material, colour and finishing (3 characters).

Dimensions [mm]

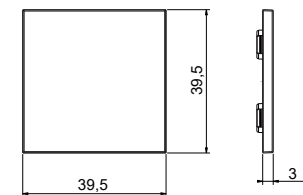

Rockers for 4-fold pushbuttons 71 series

WALL-MOUNT DEVICES



Description

Rockers for use as operation surface for pushbuttons of 71 series. They can perform two independent functions by acting on either its upper or lower zones (square and vertical rectangular versions) or on either its left or right zones (horizontal rectangular versions). Rockers are available in several colour and material variations and are passive components.

Versions

- square with 60 x 60 mm or 30 x 30 mm modularity
- rectangular with 30 x 60 mm or 60 x 15 mm modularity

Main features

- In plastic material, aluminium, Metal HT or Fenix NTM®
- Snap-on mounting
- Customizable with symbols and text

Order information

Code	Modularity * L x H [mm]	For use with **	Package
EK-T1Q-...	square 60 x 60	pushbuttons of 71 series	1 pcs.
EK-T2R-...	vertical rectangular 30 x 60		2 pcs.
EK-T4Q-...	square 30 x 30		4 pcs.
EK-T4R-...	horizontal rectangular 60 x 15		4 pcs.

*) The modularity indicated also takes into account the distance between the rockers and between rockers and light-guides and, therefore, differs slightly from the actual size of the single rockers
 **) The actual functioning as pushbutton with 1, 2 or 4 channels depends on the configuration of the device parameters carried out with ETS



Order

Base-codes must be completed by adding extensions for material, colour and finishing (3 characters) plus symbols and text (3 characters).

Note

Finishing off a 71 series pushbutton with a square rocker with 60 x 60 mm modularity does not allow the use of the integrated brightness sensor.

Dimensions [mm]

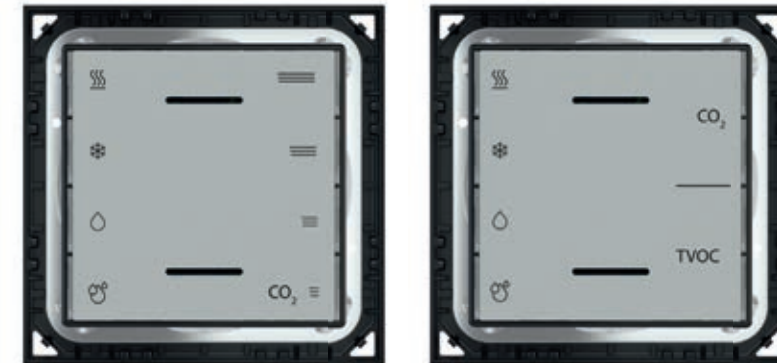
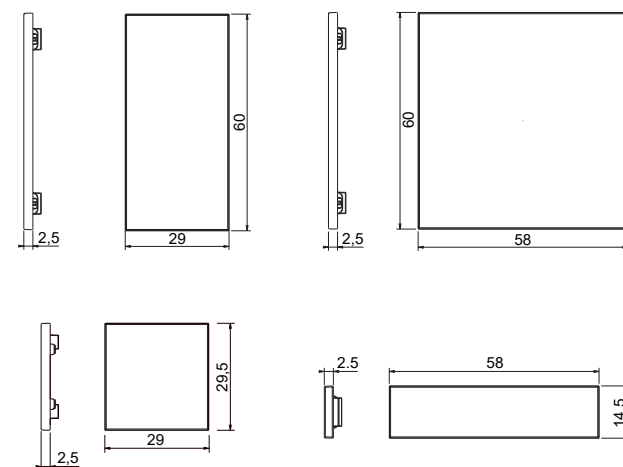

Full front cover for Multisensor

WALL-MOUNT DEVICES

Description

Front cover for Multisensor available in several colour and material variations.

Versions

- square with 60 x 60 mm modularity

Main features

- In plastic material, aluminium, Metal HT or Fenix NTM®
- Snap-on mounting

Order

Base-codes must be completed by adding extensions for material, colour and finishing (3 characters).

Dimensions [mm]

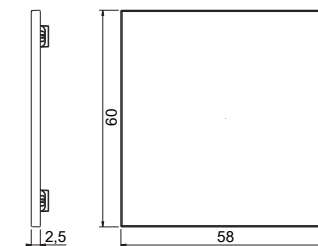

Order information

Code	Modularity * L x H [mm]	For use with	Package
EK-T1Q-...-ET2	square 60 x 60	Multisensor EK-ET3-TP	1 pcs.
EK-T1Q-...-ES2		Multisensor EK-ES3-TP	

*) The modularity indicated also takes into account the distance between the front cover and light-guides and, therefore, differs slightly from the actual size of the cover



Rockers removal accessory

WALL-MOUNT DEVICES



Description

New rockers removal accessory for wall-mounted devices FF and 71 series.

Order information

Code	For use with	Package
EK-AST-1	FF/71 series rockers removal	1 pcs.



Hole cover

WALL-MOUNT DEVICES

Description

Hole cover (55x55 mm).

Order information

Code	Modularity L x H [mm]	Package
EK-A55-...	square 55 x 55	1 pcs.

Thermoformed protection for Ekinex pushbuttons

WALL-MOUNT DEVICES



Description

Building site protection in transparent thermoformed plastic material for Ekinex® pushbuttons FF, 71, 20venti series. The use of the protection prevents soiling of the devices caused by painting. The reliefs in correspondence with each rocker allow the pushbutton to be operated even with the protection present.

Order information

Code	For use with	Package
EK-PTC-5-FF	devices of FF series	5 pcs.
EK-PTC-5-20-DE	devices of 20venti Deep series	5 pcs.
EK-PTC-5-71-DE	devices of 71 Deep series	5 pcs.
EK-PTC-5-20-SU	devices of 20venti Surface series	5 pcs.
EK-PTC-5-71-SU	devices of 71 Surface series	5 pcs.

Dimensions [mm] - FF series

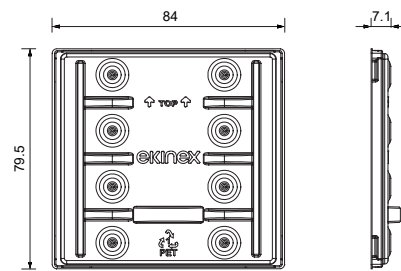

Dimensions [mm] - 71 Deep series

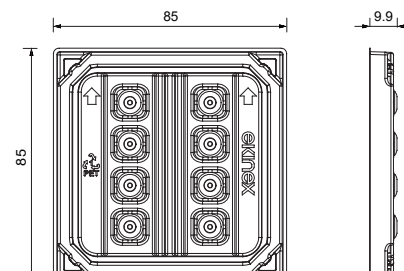

Dimensions [mm] - 20venti Deep series

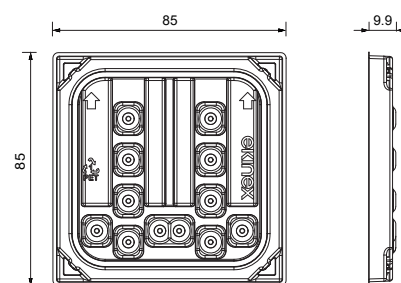

Dimensions [mm] - 71 Surface series

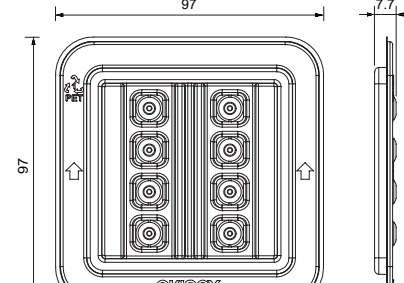

Dimensions [mm] - 20venti Surface series

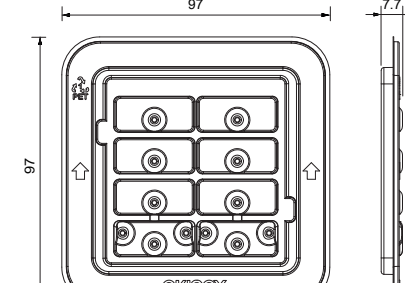

Square frame Form version

WALL-MOUNT DEVICES

Description

Square frame of Form version for finishing Ekinex® devices of FF and 71 series. Available in several colours and materials.

Main features

- In plastic material or aluminium
- Snap-on mounting

Order information

Code	Dimensions L x H x P [mm]	For use with	Package
EK-FOQ-...	86 x 86 x 8	devices of FF and 71 series	1 pcs.

Order

Base-codes (EK-FOQ) must be completed by adding extensions for material, colour and finishing (3 characters).

Dimensions [mm]

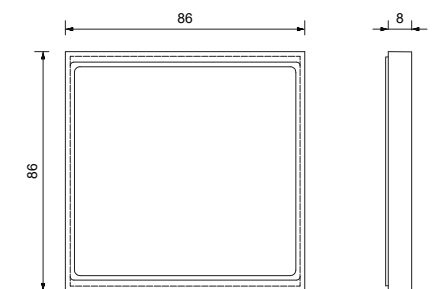

Rectangular frame Form version

WALL-MOUNT DEVICES

Description

Rectangular frame of Form version for finishing Ekinex® devices of FF and 71 series. Available in several colours and materials.

Main features

- In plastic material or aluminium
- Snap-on mounting

Order information

Code	Dimensions L x H x P [mm]	For use with	Package
EK-FOR-...	126 x 86 x 8	devices of FF and 71 series	1 pcs.

Order

Base-codes (EK-FOR) must be completed by adding extensions for material, colour and finishing (3 characters).

Dimensions [mm]

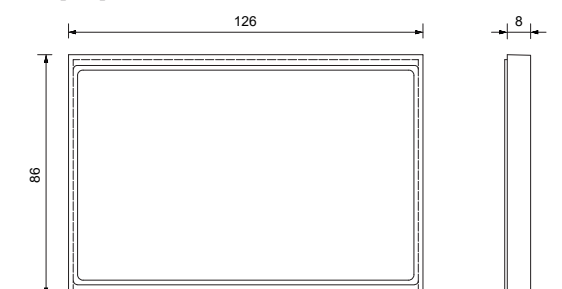



Square frame Flank version

WALL-MOUNT DEVICES

Description

Square frame of Flank version for finishing Ekinex® devices of FF and 71 series. Available in several colours and materials.

Main features

- In plastic material or aluminium
- Snap-on mounting

Order information

Code	Dimensions L x H x P [mm]	For use with	Package
EK-FLQ-...	94 x 80 x 8	Ekinex® devices of FF and 71 series	1 pcs.

Order

Base-codes (EK-FLQ) must be completed by adding extensions for material, colour and finishing (3 characters).

Dimensions [mm]

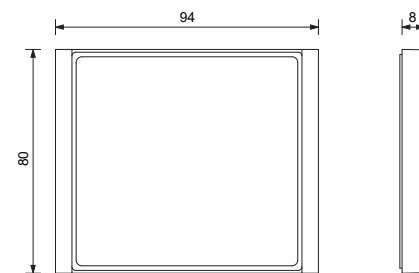

Double frame Form version

WALL-MOUNT DEVICES

Description

Double frame of Form version for finishing Ekinex® devices of 71 series. Available in several colours and materials.

Main features

- In plastic material or aluminium
- Snap-on mounting

Order information

Code	Dimensions L x H x P [mm]	For use with	Package
EK-F02-...	157 x 86 x 8	Ekinex® devices of 71 series	1 pcs.

Order

Base-codes (EK-F02) must be completed by adding extensions for material, colour and finishing (3 characters).

Dimensions [mm]

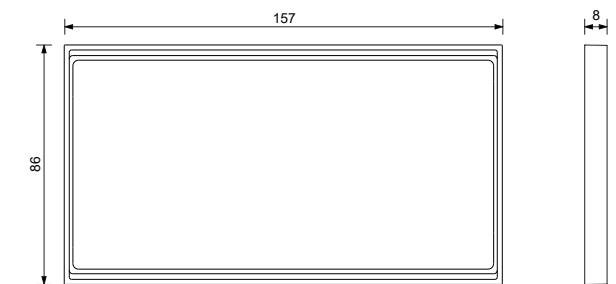

Rectangular frame Flank version

WALL-MOUNT DEVICES

Description

Rectangular frame of Flank version for finishing Ekinex® devices of FF and 71 series. Available in several colours and materials.

Main features

- In aluminium
- Snap-on mounting

Order information

Code	Dimensions L x H x P [mm]	For use with	Package
EK-FLR-...	135 x 80 x 8	Ekinex® devices of FF and 71 series	1 pcs.

Order

Base-codes (EK-FLR) must be completed by adding extensions for material, colour and finishing (3 characters).

Dimensions [mm]

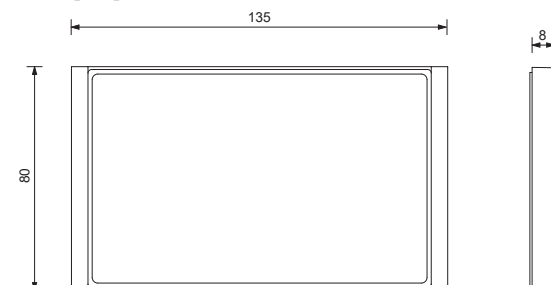

Double frame Flank version

WALL-MOUNT DEVICES

Description

Double frame of Flank version for finishing Ekinex® devices of 71 series. Available in several colours and materials.

Main features

- In plastic material or aluminium
- Snap-on mounting

Order information

Code	Dimensions L x H x P [mm]	For use with	Package
EK-FL2-...	165 x 80 x 8	Ekinex® devices of 71 series	1 pcs.

Order

Base-codes (EK-FL2) must be completed by adding extensions for material, colour and finishing (3 characters).

Dimensions [mm]

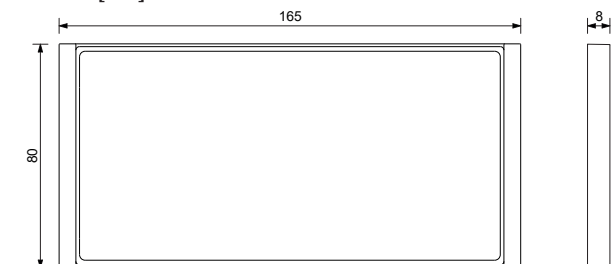



Square plate

WALL-MOUNT DEVICES

Description

Square plate for finishing Ekinex® devices of 71 series or market-standard flush-mounted inserts. Available in several colours and materials. To be used in combination with a square frame of the Form or Flank version. The plate can be also mounted without frame in combination with an adapter of the 'NF' version.

Main features

- In plastic material or aluminium or Fenix NTM®
- Snap-on mounting

Order information

Code	Window L x H [mm]	For use with*	Package
EK-PQP-...	45 x 45	standard flush-mounted inserts or Ekinex® devices	1 pcs.
EK-PQG-...	55 x 55		
EK-PQS-...	60 x 60	Ekinex® devices of 71 series	
EK-PQN-...	50 x 50	motion sensor	

Order

Base-codes must be completed by adding extensions for material, colour and finishing (3 characters).

Dimensions [mm]

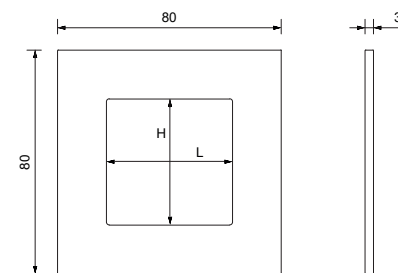

Adapter for square plate

WALL-MOUNT DEVICES



Description

Adapter for snap-on mounting of a square plate.

Main features

- Plastic material
- Mounting onto round or square mounting box with fixing holes 60 mm apart

Order information

Code	For use with	Side profile	Package
EK-TAQE-1	square plate with a Form or Flank frame	black	1 pcs.
EK-TAQE-1-NF	square plate without frame ('NF' version)	black	
EK-TAQE-1-NFW		white	
EK-TAQ-1	square plate with a Form or Flank frame (products not supplied by Ekinex)	black	1 pcs.
EK-TAQ-1-NF	square plate without frame ('NF' version) (products not supplied by Ekinex)	black	
EK-TAQ-1-NFW		white	



Rectangular plate

WALL-MOUNT DEVICES

Description

Rectangular plate for finishing market-standard flush-mounted inserts. Available in several colours and materials. To be used in combination with a rectangular frame of the Form or Flank version. The plate can be also mounted without frame in combination with an adapter of the 'NF' version.

Main features

- In plastic material or aluminium or Fenix NTM®
- Snap-on mounting

Order information

Code	Window L x H [mm]	For use with*	Package
EK-PRG-...	68 x 45	standard flush-mounted inserts	1 pcs.
EK-PRS	60 x 60	Ekinex® devices of 71 series	

Order

Base-codes must be completed by adding extensions for material, colour and finishing (3 characters).

Dimensions [mm]

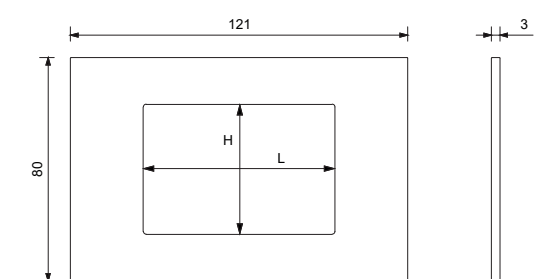

Adapter for rectangular plate

WALL-MOUNT DEVICES

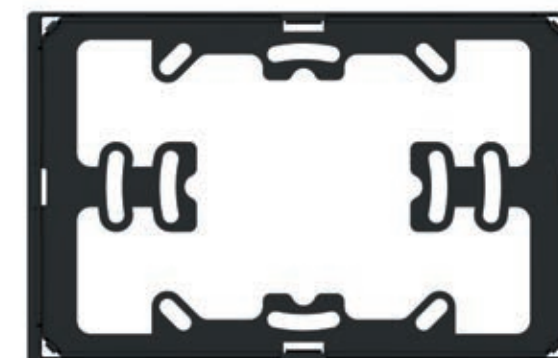

Description

Adapter for snap-on mounting of a rectangular plate.

Main features

- Plastic material
- Mounting onto round or square mounting box with fixing holes 60 mm apart or onto rectangular mounting box with fixing holes 83,5 mm apart

Order information

Code	For use with	Side profile	Package
EK-TAR-1	rectangular plate and Form or Flank frame	black	1 pcs.
EK-TAR-1-NF	rectangular plate without frame ('NF' version)	black	
EK-TAR-1-NFW		white	



Double plate

WALL-MOUNT DEVICES

Description

Double plate for finishing standard flush-mounting inserts and/or Ekinex® devices of 71 series. Available in several colours and materials. To be used in combination with a double frame of the Form or Flank version. The plate can be also mounted without frame in combination with an adapter of the 'NF' version.

Main features

- In plastic material or aluminium or Fenix NTM®
- Snap-on mounting

Order information

Code	Windows L x H [mm]	For use with*	Package
EK-P2E-...*	45 x 45 (2)	two Ekinex® devices installed 71 mm apart (devices of 71 series and/or flush-mounting inserts)	1 pcs.
EK-P2F-...*	45 x 45 (1), 60 x 60 (1)		
EK-P2P-...	55 x 55 (2)		
EK-P2G-...	55 x 55 (1), 60 x 60 (1)		
EK-P2S-...	60 x 60 (2)		

*) Not available in plastic

Order

Base-codes must be completed by adding extensions for material, colour and finishing (3 characters).

Dimensions [mm]

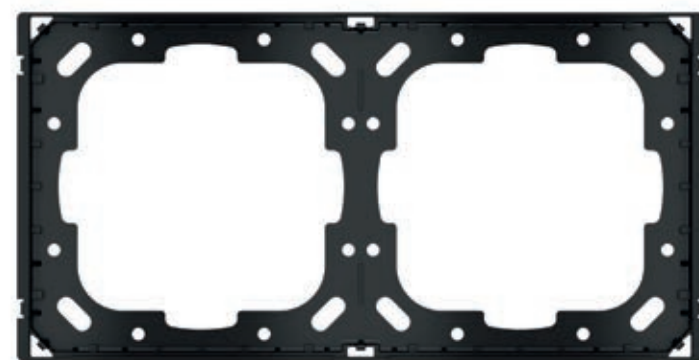
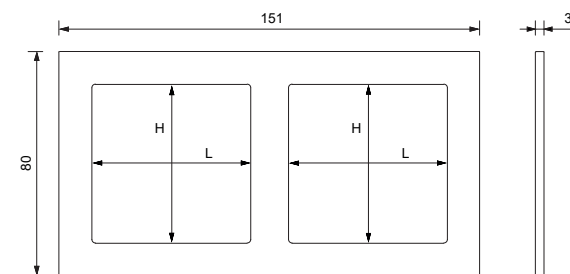

Description

Adapter for snap-on mounting of a double plate.

Main features

- In plastic material
- For mounting onto round modular flush-mounting boxes (71 mm apart)

Adapter for double plate

WALL-MOUNT DEVICES

Order information

Code	For use with	Side profile	Package
EK-A71E	double plate with a Form or Flank frame	black	1 pcs.
EK-A71E-1-NF	double plate of 71 series without frame ('NF' version)	black	
EK-A71E-1-NFW		white	
EK-A71	double plate with a Form or Flank frame (at least one product not supplied by Ekinex)	black	
EK-A71-1-NF	double plate of 71 series without frame ('NF' version) (at least one product not supplied by Ekinex)	black	
EK-A71-1-NFW		white	



Deep square plate

WALL-MOUNT DEVICES

Description

Deep version square plate for finishing Ekinex® devices of Signum, 20venti and 71 series or market-standard flush-mounted inserts. Available in several colours and materials.

Main features

- For use on round mounting box with fixing holes 60 mm apart
- In plastic material, aluminium, Metal HT or Fenix NTM®
- Snap-on mounting on adapter

Order information

Code	Window L x H [mm]	For use with	Package
EK-DQP-...	45 x 45	standard flush-mounted inserts or Ekinex® devices	1 pcs.
EK-DQG-...	55 x 55		
EK-DQT-...	30 x 60	Ekinex® devices of 20venti series (4 rockers)	
EK-DQS-...	60 x 60	Ekinex® devices of 20venti and 71 series	
EK-DQZ-...*	30 x 60	Ekinex® devices of Signum series	
EK-DQN-...	50 x 50	motion sensor	

*) Not available in plastic

Order

Base-codes must be completed by adding extensions for material, colour and finishing (3 characters).

Dimensions [mm]

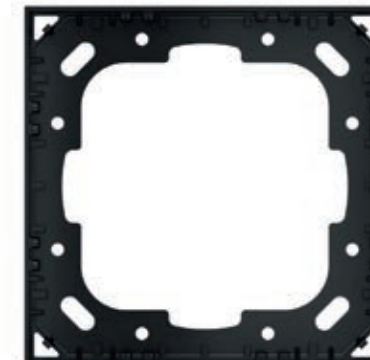
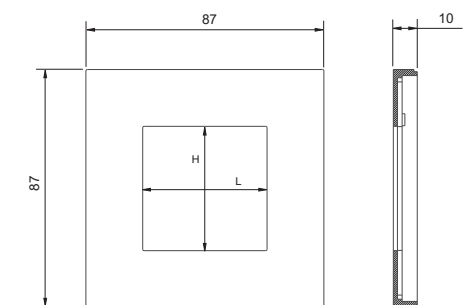

Description

Adapter for snap-on mounting of a Deep square plate.

Main features

- Plastic material
- Mounting onto round or square mounting box with fixing holes 60 mm apart

Adapter for Deep square plate

WALL-MOUNT DEVICES

Order information

Code	For use with	Side profile	Package
EK-TAQE-1-NF	Deep square plate	black	1 pcs.

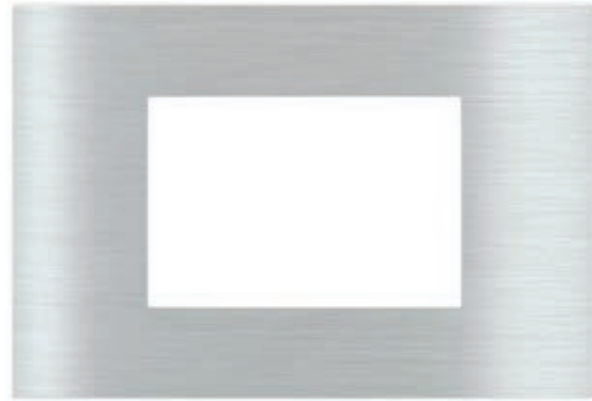

Deep rectangular plate

WALL-MOUNT DEVICES

Description

Deep version rectangular plate for finishing Ekinex® devices of 20venti and 71 series or market-standard flush-mounted inserts. Available in several colours and materials.

Main features

- Mounting onto rectangular 3 seater mounting box according to the Italian installation standard provided with fixing holes 83,5 mm apart
- In plastic material, aluminium, Metal HT or Fenix NTM®
- Snap-on mounting on adapter

Order information

Code	Window L x H [mm]	For use with	Package
EK-DRG-...	68 x 45	standard flush-mounted inserts	1 pcs.
EK-DRS-...	60 x 60	Ekinex® devices of 20venti and 71 series	

Order

Base-codes must be completed by adding extensions for material, colour and finishing (3 characters).

Dimensions [mm]

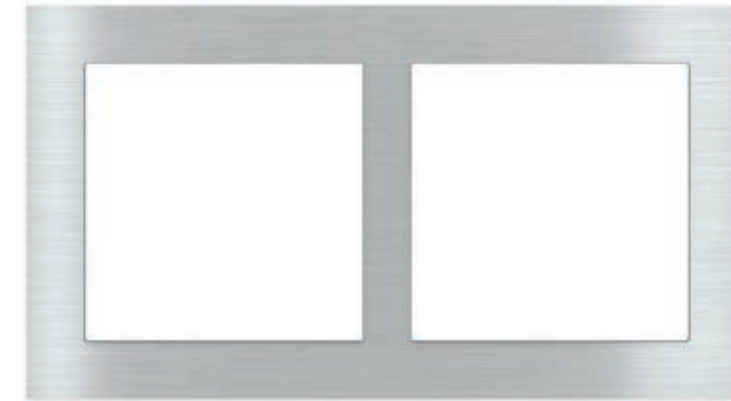
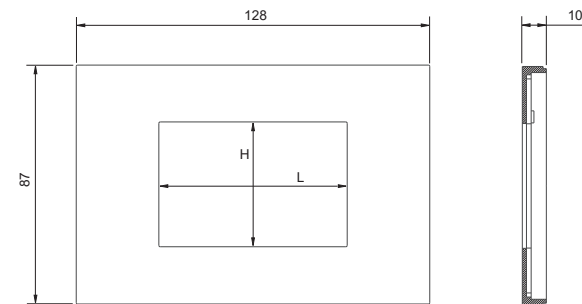

Deep double plate

WALL-MOUNT DEVICES

Description

Deep version double plate for finishing standard flush-mounting inserts and/or Ekinex® devices of 20venti and 71 series. Available in several colours and materials.

Main features

- For mounting onto mounting boxes with fixing holes 71 mm apart
- In plastic material, aluminium, Metal HT or Fenix NTM®
- Snap-on mounting on adapter

Order information

Code	Windows L x H [mm]	For use with	Package
EK-D2E	45 x 45 (2)		1 pcs.
EK-D2F	45 x 45 (1), 60 x 60 (1)	two Ekinex® devices installed 71 mm apart (devices of 20venti and 71 series and/or flush-mounting inserts)	
EK-D2P-...	55 x 55 (2)		
EK-D2G-...	55 x 55 (1), 60 x 60 (1)		
EK-D2S-...	60 x 60 (2)		

Order

Base-codes must be completed by adding extensions for material, colour and finishing (3 characters).

Dimensions [mm]

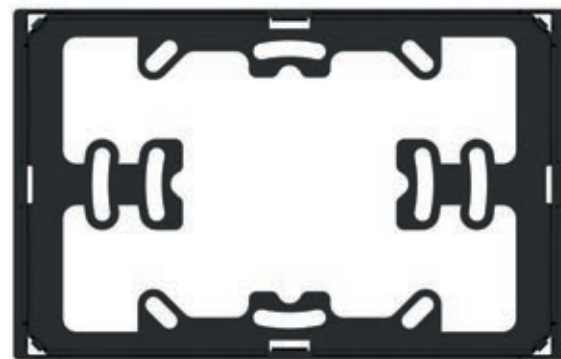
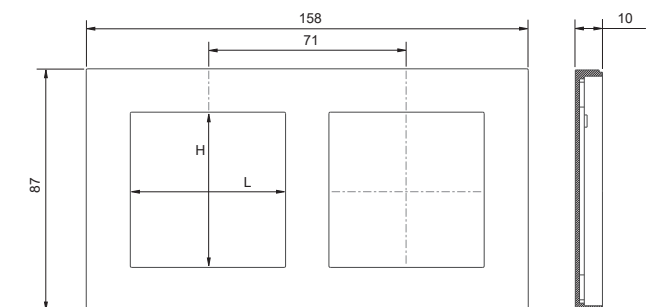

Adapter for Deep rectangular plate

WALL-MOUNT DEVICES

Description

Adapter for snap-on mounting of a Deep rectangular plate.

Main features

- Plastic material
- Mounting onto round or square mounting box with fixing holes 60 mm apart or onto rectangular mounting box with fixing holes 83,5 mm apart

Order information

Code	For use with	Side profile	Package
EK-TAR-1-NF	Deep rectangular plate	black	1 pcs.

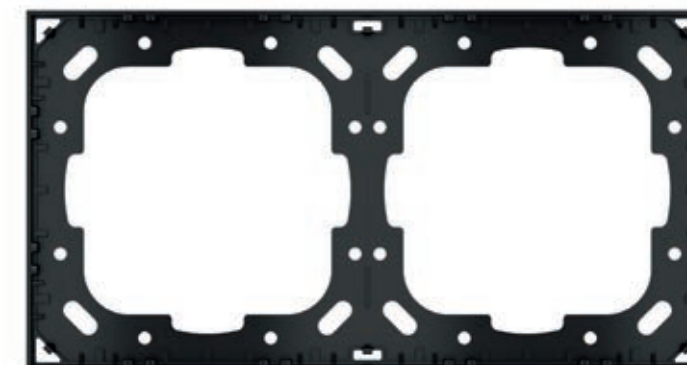

Adapter for Deep double plate

WALL-MOUNT DEVICES

Description

Adapter for snap-on mounting of a Deep double plate.

Main features

- In plastic material
- For mounting onto round modular flush-mounting boxes (71 mm apart)

Order information

Code	For use with	Side profile	Package
EK-A71E-1-NF	Deep double plate		1 pcs.
EK-A71-1-NF	double plate of 71 series without frame ('NF version') (at least one product not supplied by Ekinex)	black	

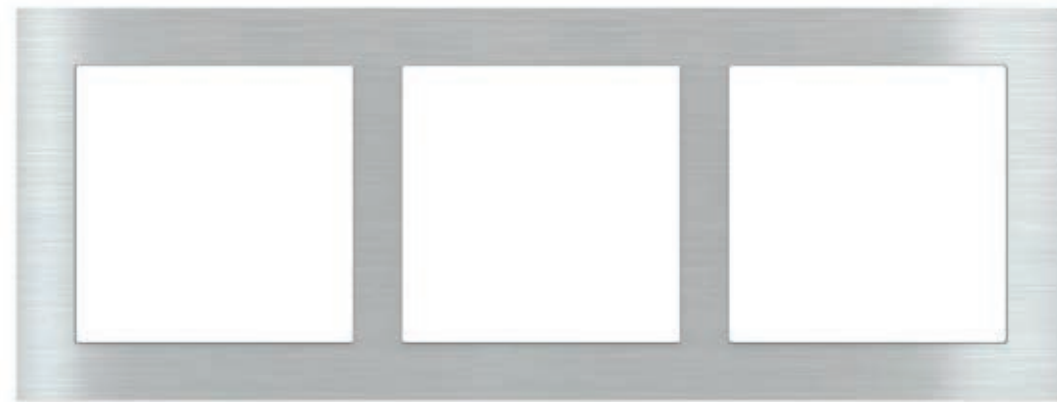

Deep triple plate

WALL-MOUNT DEVICES

Description

Deep version triple plate for finishing standard flush-mounting inserts and/or Ekinex® devices of 20venti and 71 series. Available in several colours and materials.

Main features

- For mounting onto mounting boxes with fixing holes 71 mm apart
- In aluminium, Metal HT or Fenix NTM®
- Snap-on mounting on adapter
- Customisation of windows on aluminium or Fenix NTM® plates on request

Order information

Code	Windows L x H [mm]	For use with	Package
EK-D3P-...	55 x 55 (3)	three Ekinex® devices installed 71 mm apart (devices of 20venti and 71 series and/or flush-mounting inserts)	1 pcs.
EK-D3G-...	60 x 60 (1) 55 x 55 (2)		
EK-D3X- XXX-...	XXX (4,5,6) Custom window*		

(*) 45 x 45 mm - 55 x 55 mm - 60 x 60 mm

Order

Base-codes must be completed by adding extensions for material, colour and finishing (3 characters).

Dimensions [mm]

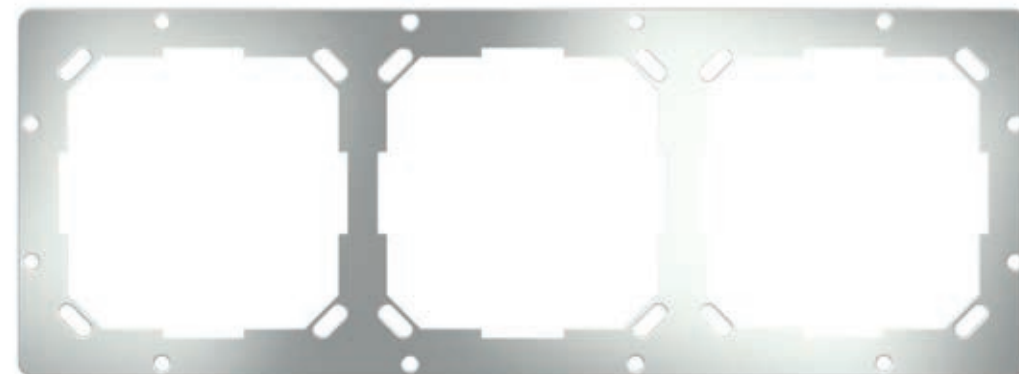
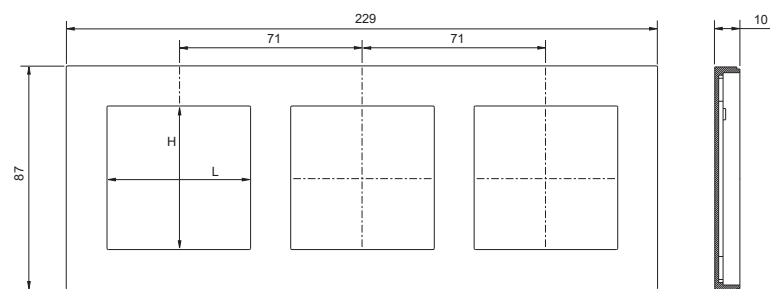

Adapter for Deep triple plate

WALL-MOUNT DEVICES

Description

Adapter for snap-on mounting of a Deep triple plate.

Main features

- In aluminium
- For mounting onto round modular flush-mounting boxes (71 mm apart)

Order information

Code	For use with	Side profile	Package
EK-B71-1-NF	Deep triple plate	black	1 pcs.



Surface square plate

WALL-MOUNT DEVICES

Description

Surface version square plate for finishing Ekinex® devices of 20venti and 71 series or market-standard flush-mounted inserts. Available in several colours and materials.

Main features

- For use on round mounting box with fixing holes 60 mm apart
- In aluminium, Metal HT or Fenix NTM®
- Snap-on mounting on adapter

Order information

Code	Window L x H [mm]	For use with	Package
EK-SQP-...	45 x 45	standard flush-mounted inserts or Ekinex® devices	1 pcs.
EK-SQG-...	55 x 55		
EK-SQT-...	30 x 60	Ekinex® devices of 20venti series (4 rockers)	1 pcs.
EK-SQS-...	60 x 60	Ekinex® devices of 20venti and 71 series	
EK-SQZ-...	30 x 60	Ekinex® devices of Signum series	
EK-SQN-...	50 x 50	motion sensor	

Order

Base-codes must be completed by adding extensions for material, colour and finishing (3 characters).

Dimensions [mm]

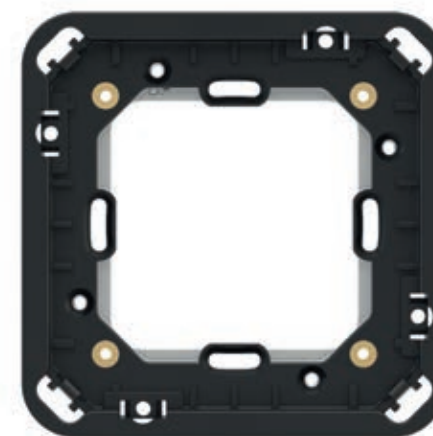
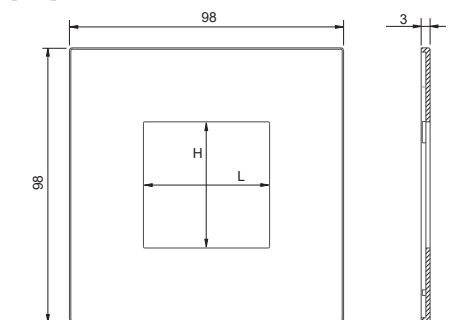

Adapter for Surface square plate

WALL-MOUNT DEVICES

Description

Adapter for mounting a square Surface plate.

Main features

- 1x plastic square Surface adapter frame
- 8x M3x6 countersunk flat head screws (EK-TAS-Q-W)
- 1x Surface square adjustment metal bracket with countersink (EK-TAS-Q-W)
- 4x guide inserts for Surface installation in plasterboard (EK-TAS-Q-N)
- 4x 44.5 mm long cavity wall anchor screws (EK-TAS-Q-N)
- 4x metal tabs (EK-TAS-Q-N)

- 4x M3x6 countersunk flat head screws with cross recess (EK-TAS-Q-N)
- 1x cardboard mounting template 86x86 mm (EK-TAS-Q-N)
- 2x 2.9x25 and 2.9x38 mm countersunk flat head cross recessed and self-tapping screws

Order information

Code	For use with	Side profile	Package
EK-TAS-Q-W	for mounting a double Surface plate on masonry walls	black	1 pcs.
EK-TAS-Q-N	for mounting a double Surface plate on plasterboard walls		

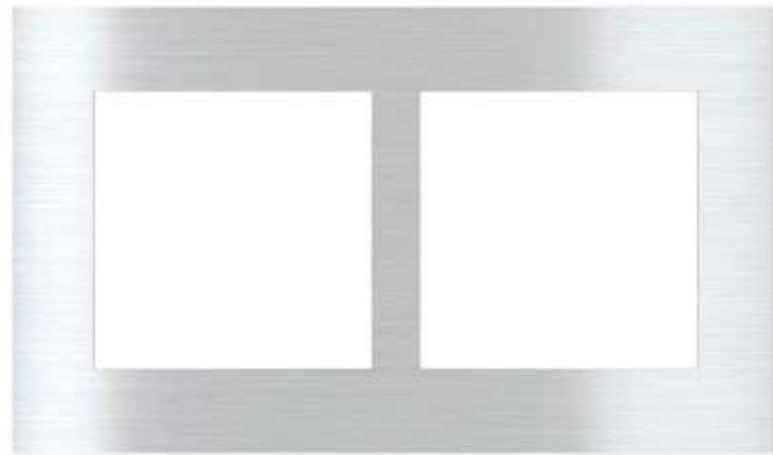

Surface double plate

WALL-MOUNT DEVICES

Description

Surface version double plate for finishing standard flush-mounting inserts and/or Ekinex® devices of 20venti and 71 series. Available in several colours and materials.

Main features

- For mounting onto mounting boxes with fixing holes 71 mm apart
- In aluminium, Metal HT or Fenix NTM®
- Snap-on mounting on adapter

Order information

Code	Windows L x H [mm]	For use with	Package
EK-S2E	45 x 45 (2)	two devices installed 71 mm apart (devices of 20venti and 71 series and/or flush-mounting inserts)	1 pcs.
EK-S2F	45 x 45 (1), 60 x 60 (1)		
EK-S2P-...	55 x 55 (2)		
EK-S2G-...	55 x 55 (1), 60 x 60 (1)		
EK-S2S-...	60 x 60 (2)		

Order

Base-codes must be completed by adding extensions for material, colour and finishing (3 characters).

Dimensions [mm]

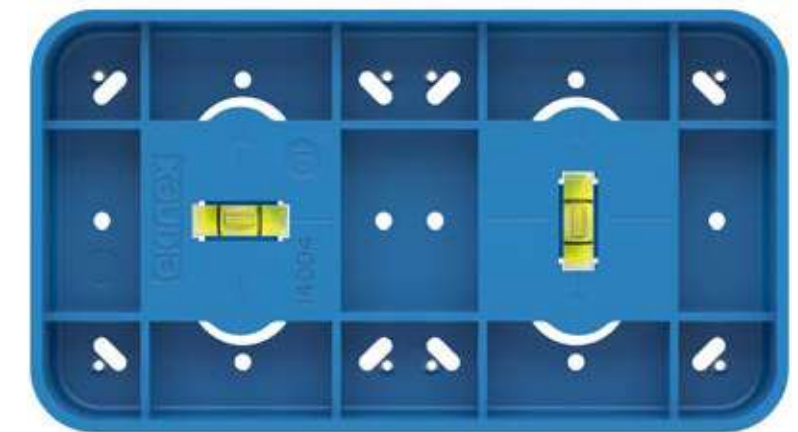
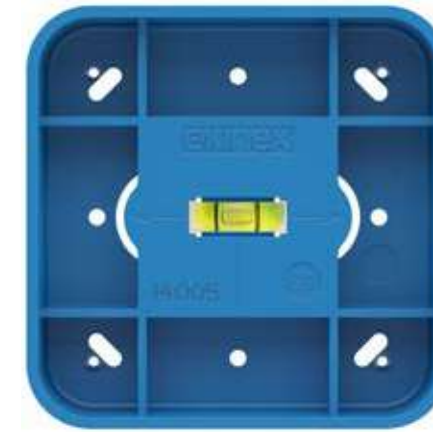
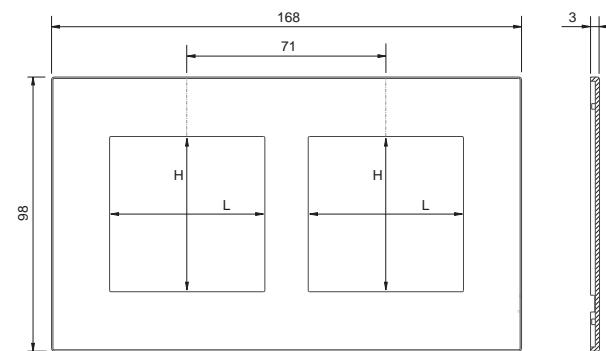

Template for Surface plates

WALL-MOUNT DEVICES

Description

Template for making holes during wall plastering in order to mount a Surface plate-adapter bundle.

Main features

- Plastic material
- With spirit level for perfect horizontal alignment
- Mounting onto round or square mounting box with fixing holes 60 mm apart
- Double template for flush-mounting boxes with centre distance 71 mm

Delivery

The template (EK-DDS-...) for mounting the Surface adapter-plate assembly must be ordered separately.

Order information

Code	Dimensions L x H x P [mm]	For use with	Package
EK-DSS-Q-W	87 x 87 x 10	Template for square plate	1 pcs.
EK-DSS-D-W	157 x 87 x 10	Template for double plate	

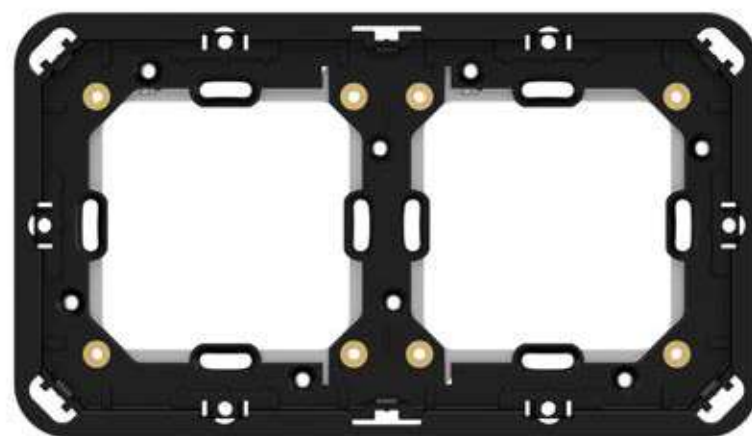

Adapter for Surface double plate

WALL-MOUNT DEVICES

Description

Adapter for mounting of a Surface double plate.

Main features

- 1x Surface square plastic adapter frame
- 8x M3x6 countersunk flat head screws (EK-TAS-D-W)
- 2x square Surface adjustment metal bracket with countersink (EK-TAS-D-W)
- 6x guide inserts for Surface installation in plasterboard (EK-TAS-D-N)
- 6x 44.5 mm long cavity wall anchor screws (EK-TAS-D-N)

- 6x metal tabs (EK-TAS-D-N)
- 8x M3x6 countersunk flat head screws with cross recess (EK-TAS-D-N)
- 1x cardboard mounting template 156x86 mm (EK-TAS-D-N)
- 4x 2.9x25 and 2.9x38 mm countersunk flat head screws with cross recess and self-tapping

Order information

Code	For use with	Side profile	Package
EK-TAS-D-W	for mounting a double Surface plate on masonry walls	black	1 pcs.
EK-TAS-D-N	for mounting a double Surface plate on plasterboard walls		

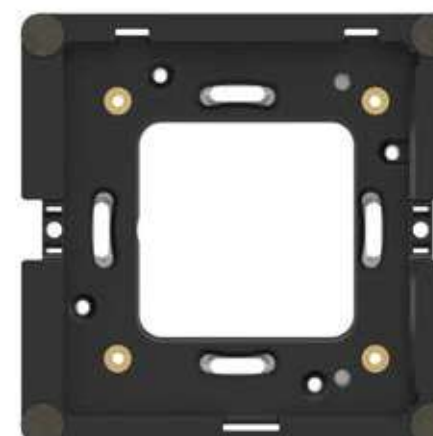

Adapter for Signum Surface square plate

WALL-MOUNT DEVICES

Description

Adapter for mounting a square Signum Surface plate.

Main features

- 1x plastic square Signum Surface adapter frame
- 8x M3x6 countersunk flat head screws (EK-TAS-V-W)
- 1x Surface square adjustment metal bracket with countersink (EK-TAS-V-W)
- 4x guide inserts for Surface installation in plasterboard (EK-TAS-V-N)
- 4x 44.5 mm long cavity wall anchor screws (EK-TAS-V-N)
- 4x metal tabs (EK-TAS-V-N)

- 4x M3x6 countersunk flat head screws with cross recess (EK-TAS-V-N)
- 1x cardboard mounting template 86x86 mm (EK-TAS-V-N)
- 2x 2.9x25 and 2.9x38 mm countersunk flat head cross recessed and self-tapping screws

Order information

Code	For use with	Side profile	Package
EK-TAS-V-W	for mounting a double Surface plate on masonry walls	black	1 pcs.
EK-TAS-V-N	for mounting a double Surface plate on plasterboard walls		

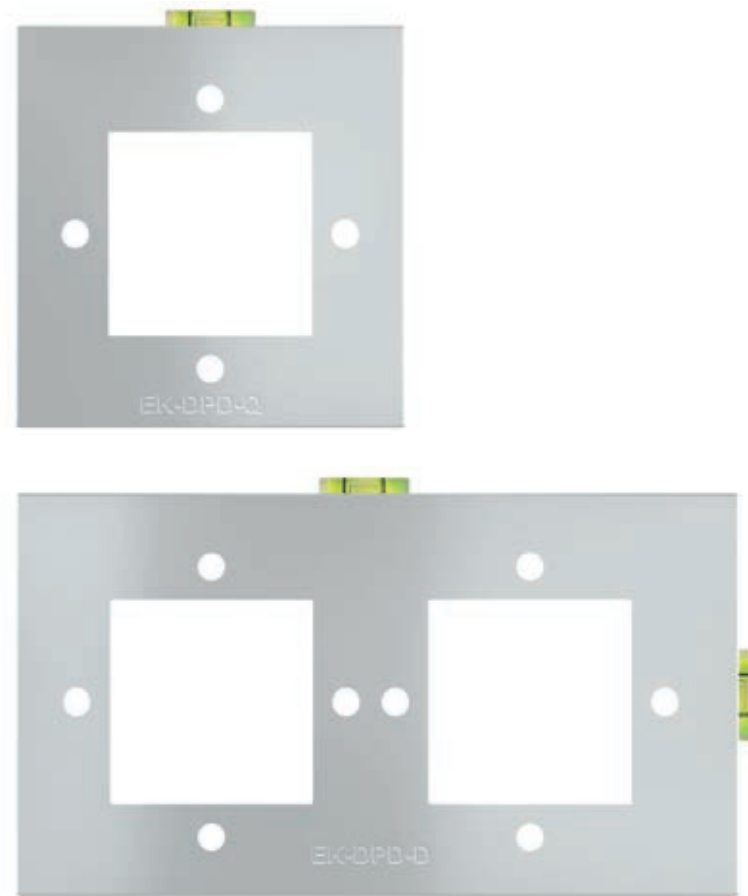

Templates for installation of civil series components on 'NF/Deep applications

WALL-MOUNT DEVICES

Description

Templates facilitating the placement (pre-assembly) of commercial civil series components on NF' and Deep applications. Mounting on 2-position box.

Main features

- Made of machined, unpainted aluminium
- With spirit level for perfect horizontal alignment
- Mounting on round or square flush-mounting box (hole spacing 60 mm)
- Double template for mounting on flush-mounting box with device centre distance 71 mm

Order information

Code	Dimensions L x H x P [mm]	For use with	Package
EK-DPD-Q	87 x 90 x 8.7	Template for square plate	1 pcs.
EK-DPD-D	160 x 90 x 9.7	Template for double plate	

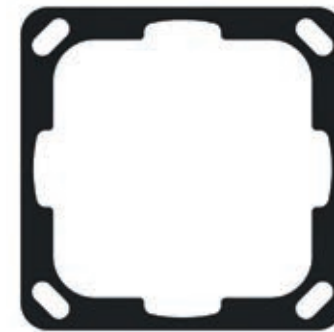

Square mounting support (for devices not supplied by Ekinex)

WALL-MOUNT DEVICES

Description

Square rubber mounting support for mounting devices or components not supplied by Ekinex.

Order information

Code	Dimensions L x H x P [mm]	For use with	Package
EK-TFC-1	69.5 x 69.5 x 2	devices not supplied by Ekinex	1 pcs..

Dimensions [mm]

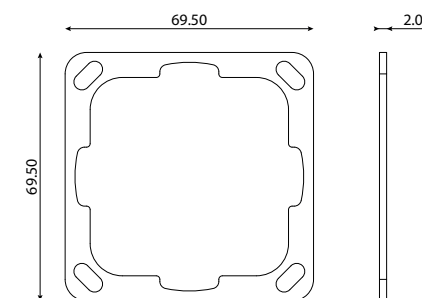

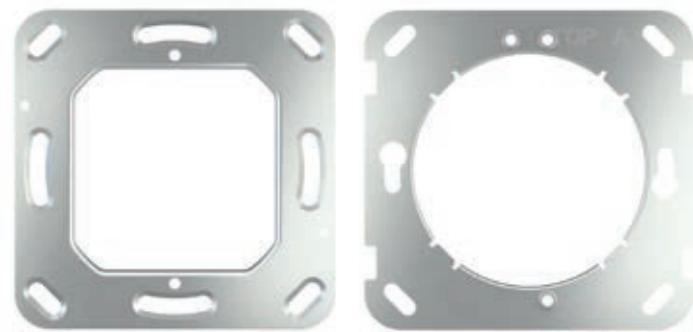

Square mounting support

WALL-MOUNT DEVICES

Description

Square metallic support for mounting Ekinex® devices onto round or square mounting boxes with fixing holes 60 mm apart.

Order information

Code	Dimensions L x H x P [mm]	For use with	Package
EK-SMQ-1	72 x 70 x 5	thermostats and Touch&See FF series	1 pcs.
EK-SMQ-71-1	70 x 70 x 4,5	devices of 20venti or 71 series and 4-fold pushbutton of FF series	
EK-SMQ-71-S	70 x 70 x 4,5	devices of Signum	

Dimensions [mm]

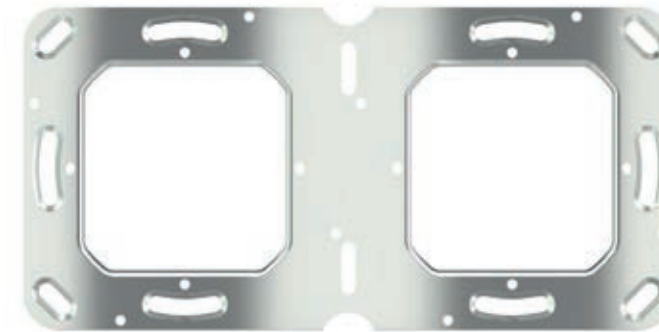
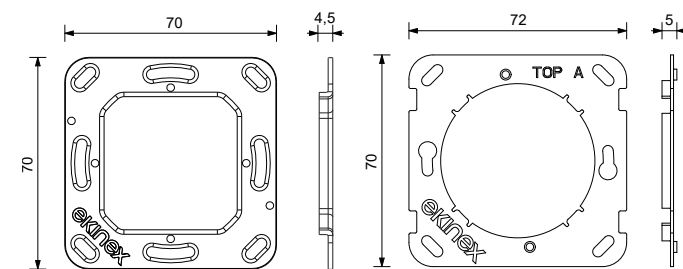

2-place mounting support

WALL-MOUNT DEVICES

Description

2-place metal support for mounting a 20venti and 71 series device on a 2-place flush-mount box (fixing holes with 71 mm spacing). Fixing screws included.

Order information

Code	Dimensions L x H x P [mm]	For use with	Package
EK-SM2-71-1	141 x 70 x 5	20venti and 71 series devices	1 pcs.

Dimensions [mm]

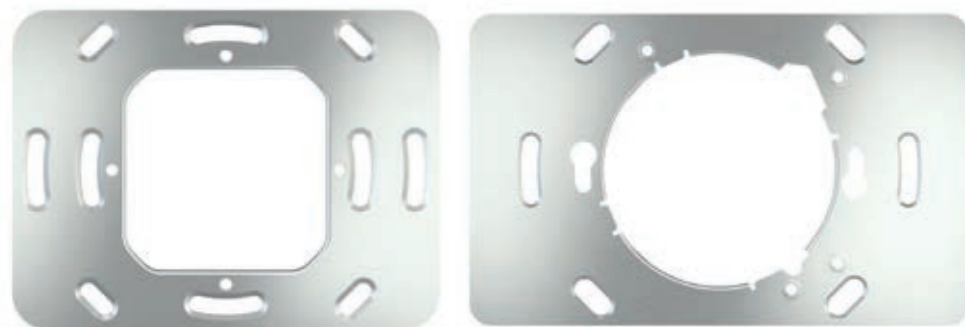
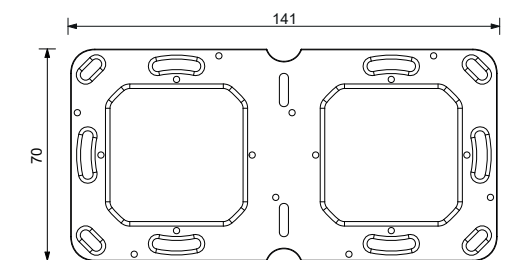

Rectangular mounting support

WALL-MOUNT DEVICES

Description

Rectangular metallic support for mounting Ekinex® devices onto round or square mounting boxes with fixing holes 60 mm apart or onto rectangular, 3-seater mounting box with fixing holes 85 mm apart.

Order information

Code	Dimensions L x H x P [mm]	For use with	Package
EK-SMR-1	110 x 68 x 5	Touch&See with 2-fold pushbutton of FF series	1 pcs.
EK-SMR-71-1	93,5 x 70 x 4,5	devices of 20venti or 71 series and 4/6-fold pushbutton of FF series	

Dimensions [mm]

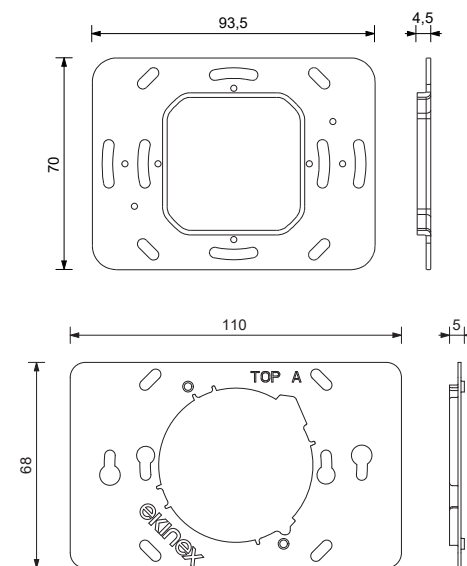

Template for side-by-side mounting of FF series with Form/Flank frames

WALL-MOUNT DEVICES

Dimensions [mm]

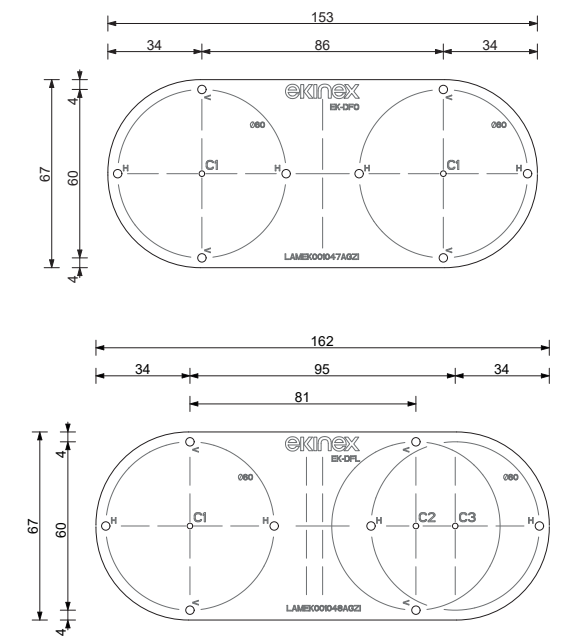

Description

Template for horizontal or vertical double-mounting of two Ekinex® devices of FF series with square frame of the Form and Flank version. Made of zinc-plated metal sheet, 1 mm thick. Employ depends on wall type (brick or movable walls).

Order information

Code	Frames	For use with	Package
EK-DFO	Form	2 devices of FF series completed with square Form frames	5 pcs.
EK-DFL	Flank	2 dispositivi serie FF completati con cornici quadrate Flank	5 pz.

Solutions for the Swiss market

WALL-MOUNT DEVICES



The following components are used for the Swiss market:

- Double plate with 60 x 60 mm windows that allows the side-by-side installation of an Ekinex® device from 20venti or 71 series and a power socket (Feller) with 60 x 60 mm modularity or two power sockets (Feller) with 60 x 60 mm modularity with 68 mm spacing.
- Double plate with 60 x 60 mm windows that allows two Ekinex® devices from 20venti or 71 series to be mounted side by side with a distance between centres of 71 mm.
- Square plate with 60 x 60 mm windows allowing the mounting of a power socket (Feller) with 60 x 60 mm modularity. Installation is only possible if the corresponding support (EK-TAQ-1-CH) is used.
- Single and double metal mounting supports for horizontal/vertical installation

The plate can be mounted without frame (NF or Deep) or with double frame Form version.

The double plate with 60 x 60 mm modularity and 68 mm spacing is available in aluminium or Fenix NTM®.

Installation can be done horizontally or vertically using the mounting supports.

Requirements for the flush mount box(es)

- Fixing holes in corner position

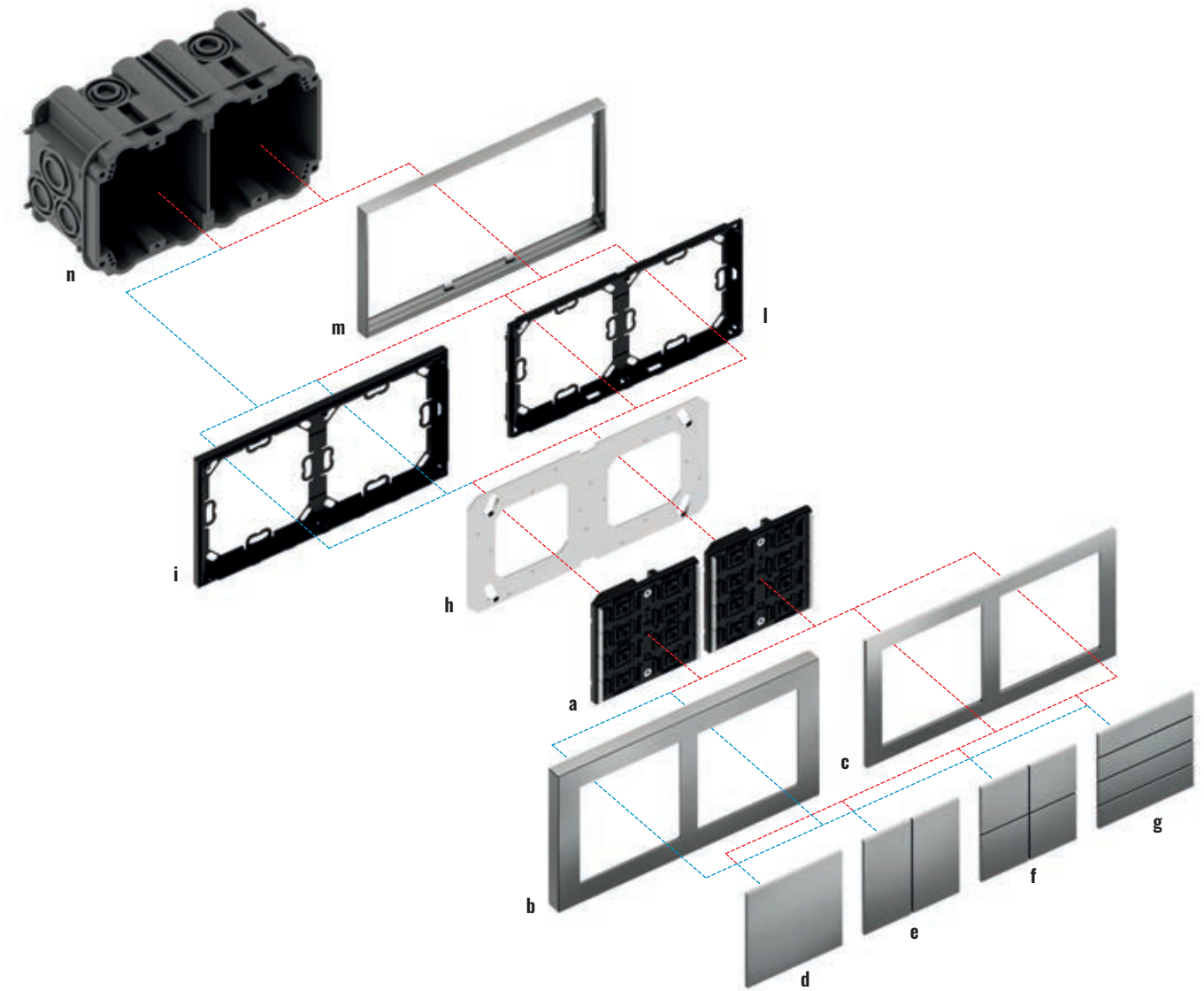

Double pushbutton installation 71 series

Description	Code
a) Pushbutton 71 series	EK-E13-TP-... o EK-E23-TP-...
b) Deep double plate*	EK-D2S-...
c) Double plate*	EK-P2S-...
d) Square rocker (1)	EK-T1Q-...
e) Rectangular vertical rockers (2)	EK-T2R-...
f) Square rockers (4)	EK-T4Q-...
g) Rectangular horizontal rockers (4)	EK-T4R-...
h) Metal mounting support**	EK-SM2-CHX

Description	Code
i) Double adapter for frame-free installation	EK-A71E-1-NF
j) Adapter for double plate with a Form or Flank frame	EK-A71E
m) Form version double frame	EK-F02-...
n) Double box for masonry walls (centre distance 60 mm)	not delivered by Ekinex®
*) 60 x 60 mm windows	
**) Available for horizontal or vertical mounting	

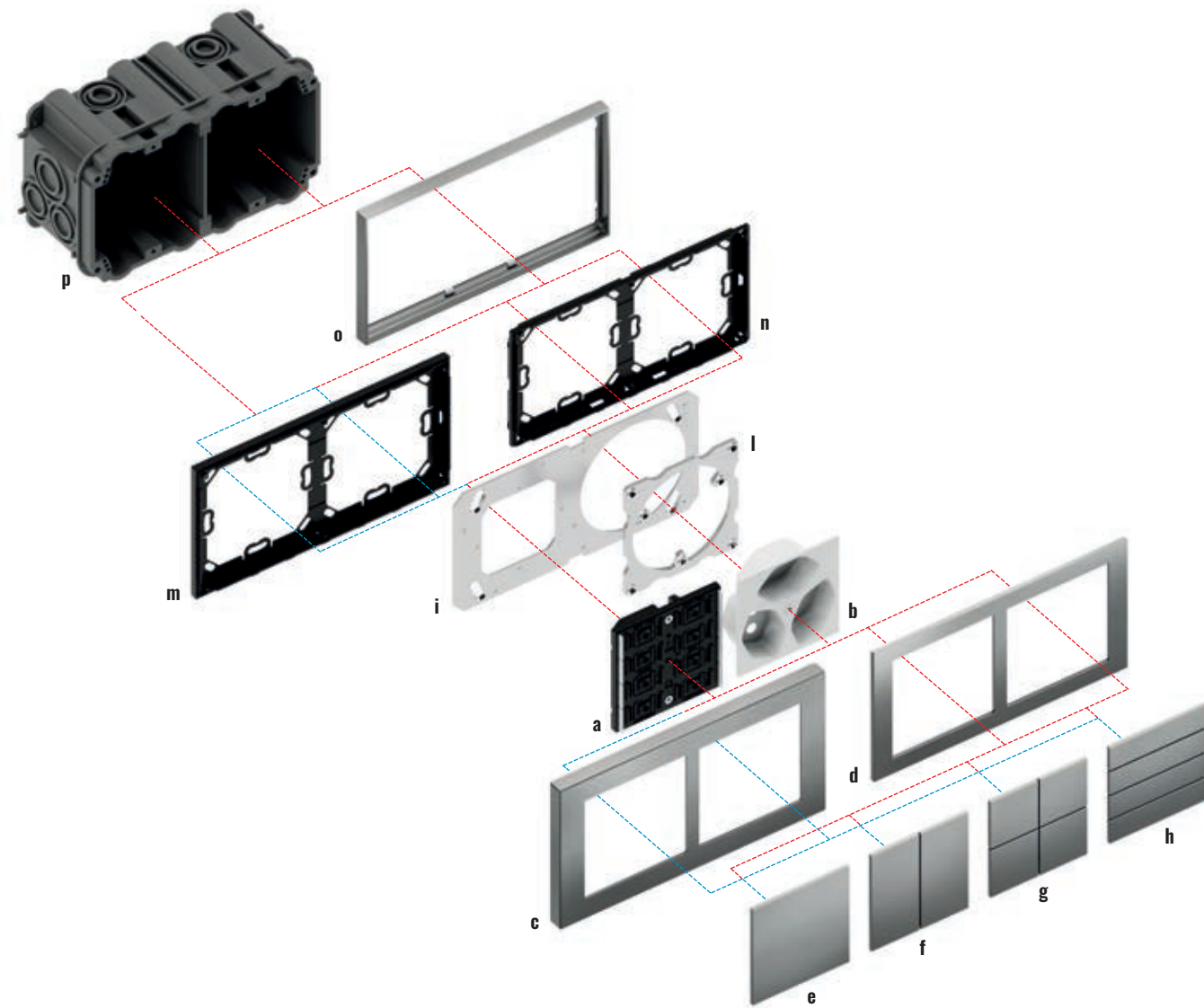

Double pushbutton installation 71 series + power socket (60 x 60 mm)

Description	Code
a) Pushbutton 71 series	EK-E13-TP-... or EK-E23-TP-...
b) Power socket 60 x 60 mm	not delivered by Ekinex®
c) Deep double plate*	EK-D2H-...
d) Double plate*	EK-P2H-...
e) Square rocker (1)	EK-T1Q-...
f) Rectangular vertical rockers (2)	EK-T2R-...
g) Square rockers (4)	EK-T4Q-...
h) Rectangular horizontal rockers (4)	EK-T4R-...
i) Metal mounting support**	EK-SM2-CHY

Description	Code
l) Metal mounting support**	EK-SM1-CHT
m) Double adapter for frame-free installation	EK-A71-1-NF
n) Adapter for double plate with a Form or Flank frame	EK-A71
o) Form version double frame	EK-FO2-...
p) Double box for masonry walls (centre distance 60 mm)	not delivered by Ekinex®
*) 60 x 60 mm windows	
**) Available for horizontal or vertical mounting	

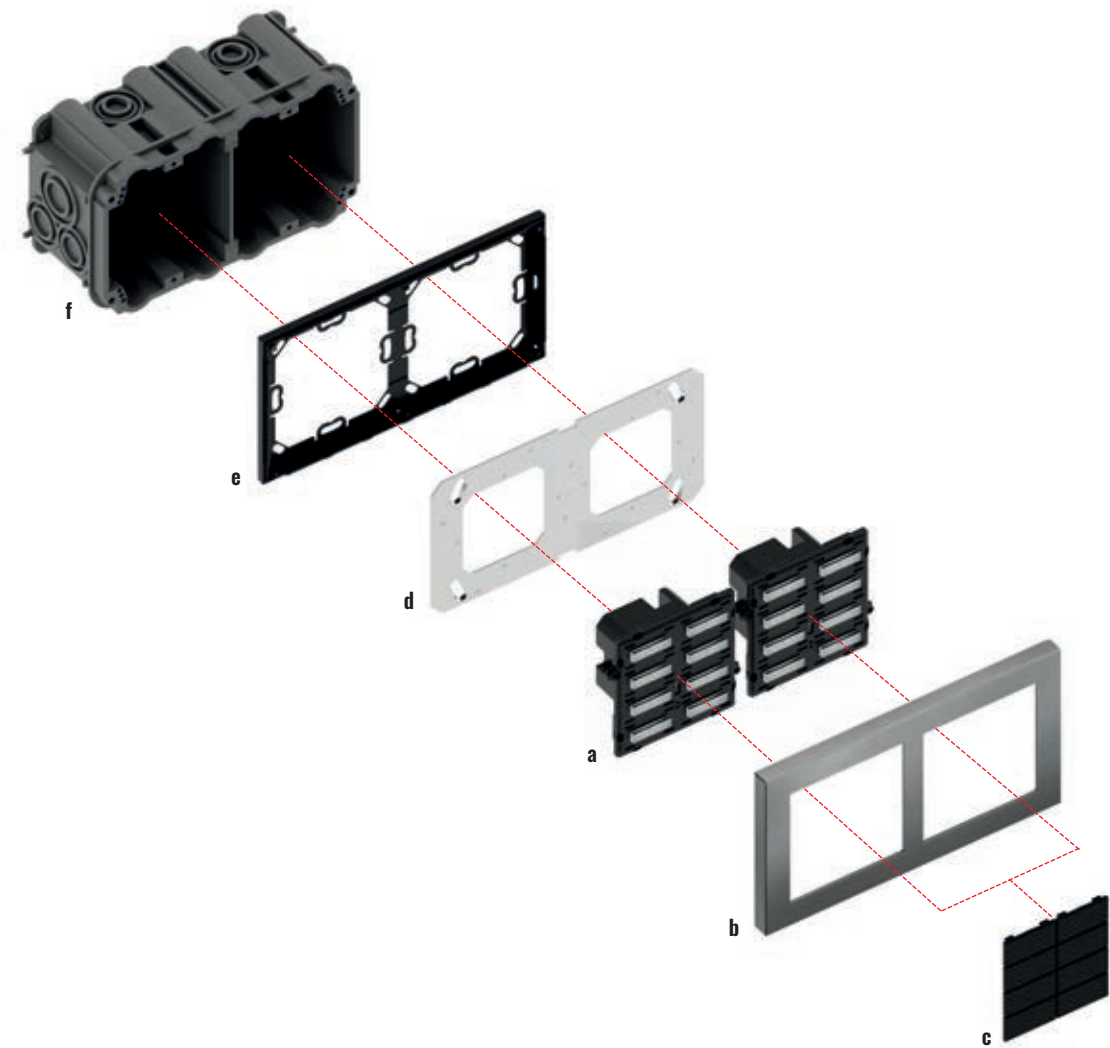

Double pushbutton installation 20venti series

Description	Code
a) Pushbutton 20venti series	EK-E2E-TP-8
b) Deep double plate*	EK-D2S-...
c) Rectangular horizontal rockers	EK-T4R-20-...
d) Metal mounting support**	EK-SM2-CHX

Description	Code
e) Double adapter for frame-free installation	EK-A71E-1-NF
f) Double box for masonry walls (centre distance 60 mm)	not delivered by Ekinex®
*) 60 x 60 mm windows	
**) Available for horizontal or vertical mounting	

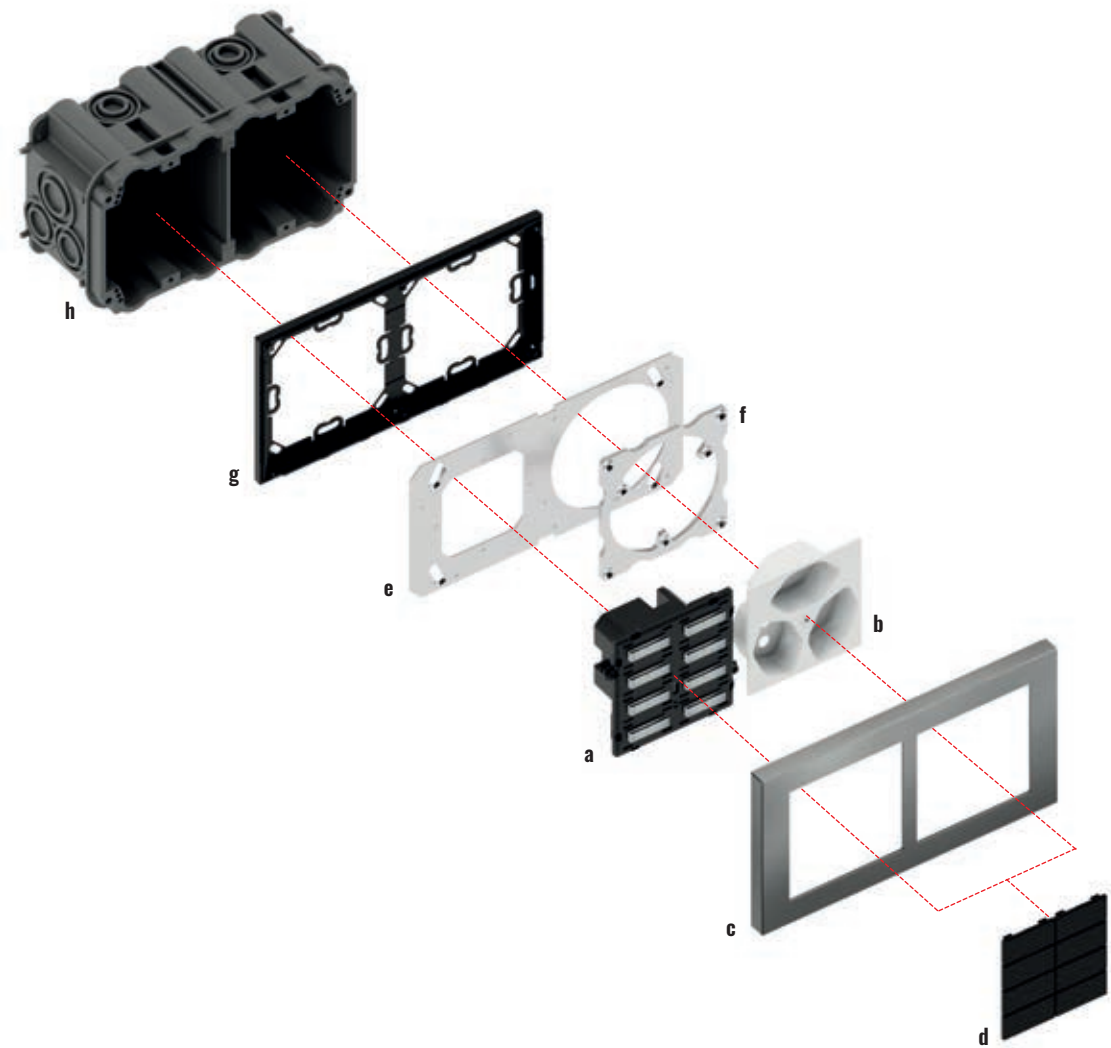

Double pushbutton installation 20venti series + power socket (60 x 60 mm)

Description	Code
a) Pushbutton 20venti series	EK-E2E-TP-8
b) Power socket 60 x 60 mm	not delivered by Ekinex®
c) Deep double plate*	EK-D2H-...
d) Rectangular horizontal rockers	EK-T4R-20-...
e) Metal mounting support**	EK-SM2-CHY

Description	Code
f) Metal mounting support**	EK-SM1-CHT
g) Double adapter for frame-free installation	EK-A71-1-NF
h) Double box for masonry walls (centre distance 60 mm)	not delivered by Ekinex®
*) 60 x 60 mm windows	
**) Available for horizontal or vertical mounting	

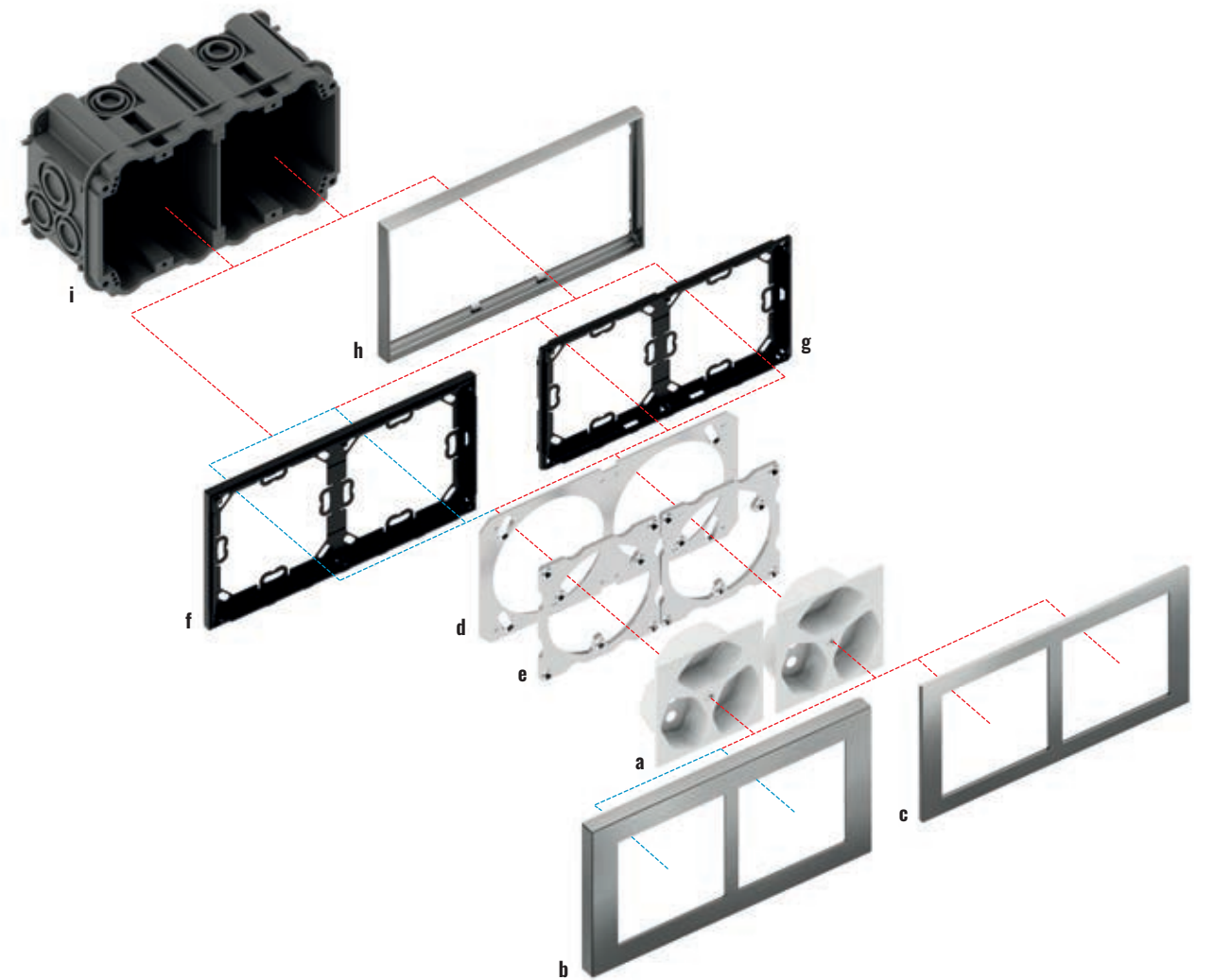

Double power sockets installation (60 x 60 mm)

Description	Code
a) Power socket 60 x 60 mm	not delivered by Ekinex®
b) Deep double plate*	EK-D2H-...
c) Double plate*	EK-P2H-...
d) Metal mounting support**	EK-SM2-CHZ
e) Metal mounting support**	EK-SM1-CHT
f) Double adapter for frame-free installation	EK-A71-1-NF

Description	Code
g) Adapter for double plate with a Form or Flank frame	EK-A71
h) Form version double frame	EK-F02-...
i) Double box for masonry walls (centre distance 60 mm)	not delivered by Ekinex®
*) 60 x 60 mm windows	
**) Available for horizontal or vertical mounting	

Mounting supports

WALL-MOUNT DEVICES

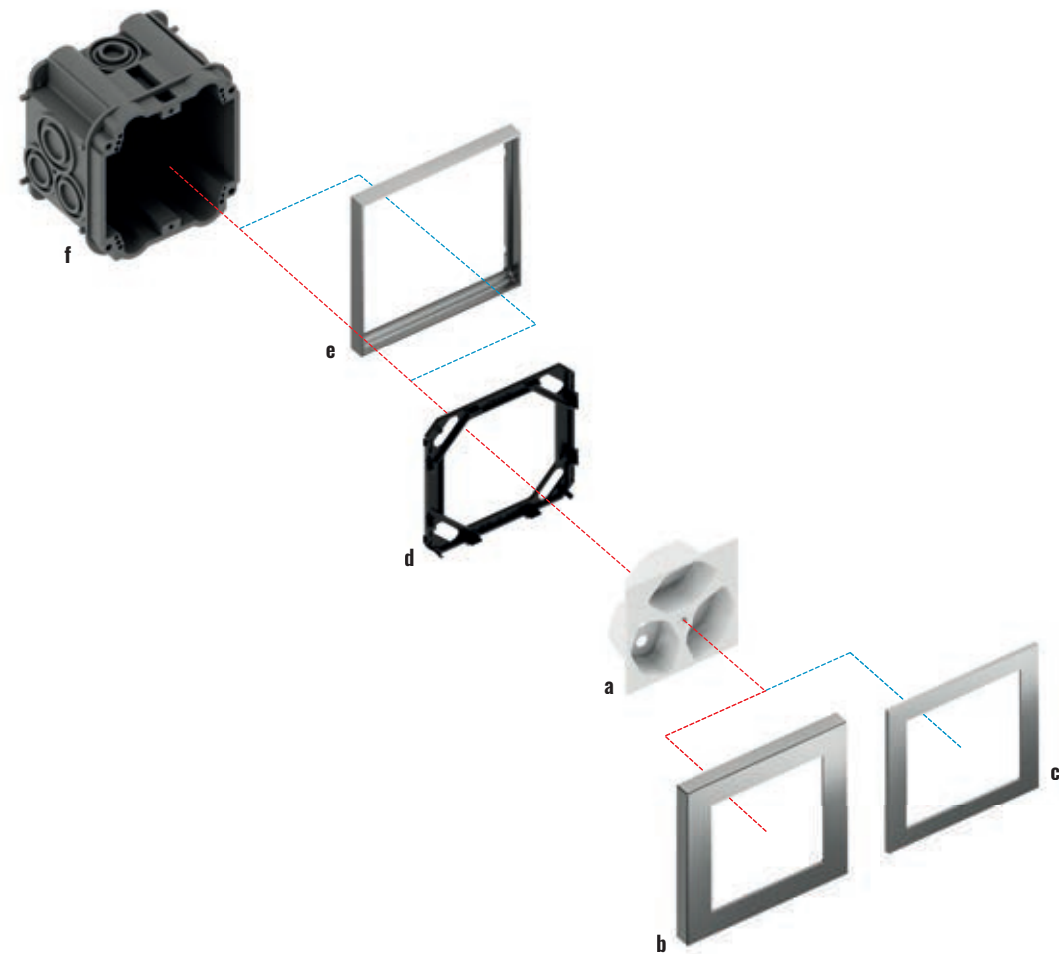

Power socket installation (60 x 60 mm)

Description	Code
a) Power socket 60 x 60 mm	not delivered by Ekinex®
b) Deep square plate*	EK-D2C-...
c) Square plate*	EK-P2C-...
d) Adapter for square plate	EK-TAQ-1-CH

Description	Code
e) Form version square frame	EK-FOQ-...
f) Double box for masonry walls (centre distance 60 mm)	not delivered by Ekinex®
*) 60 x 60 mm windows	

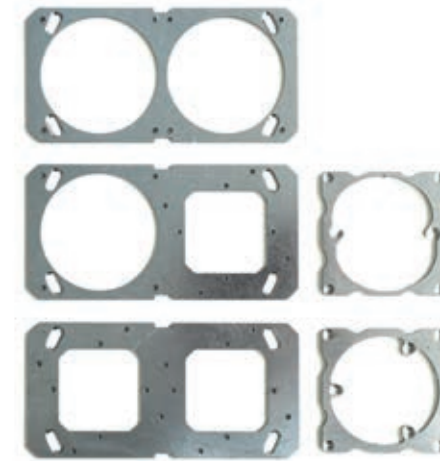

Single mounting supports

Single replacement metal support for mounting of single or triple socket (Feller). Fixing screws included.

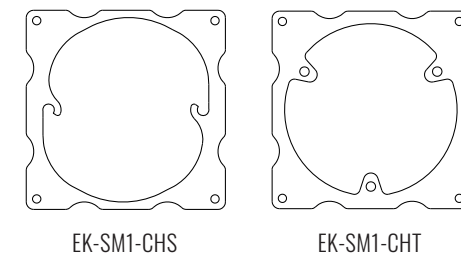

Dimensions [mm]

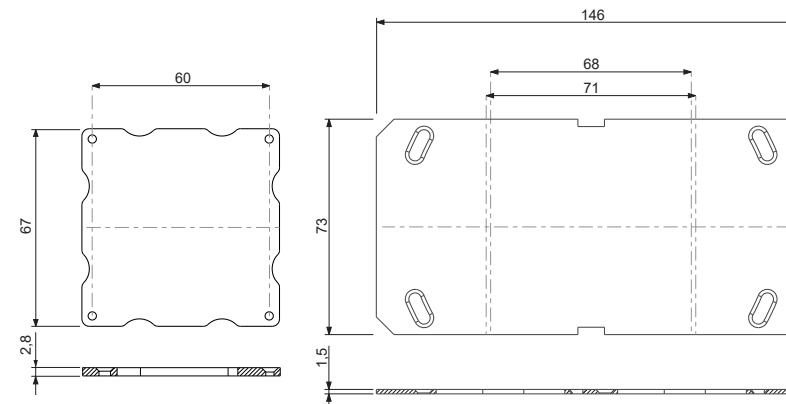

Double mounting supports (horizontal/vertical)

Double metal support for mounting two power sockets (Feller), one Ekinex® device from 20venti or 71 series and one power sockets (Feller), two Ekinex® devices from 20venti or 71 series. Fixing screws included.

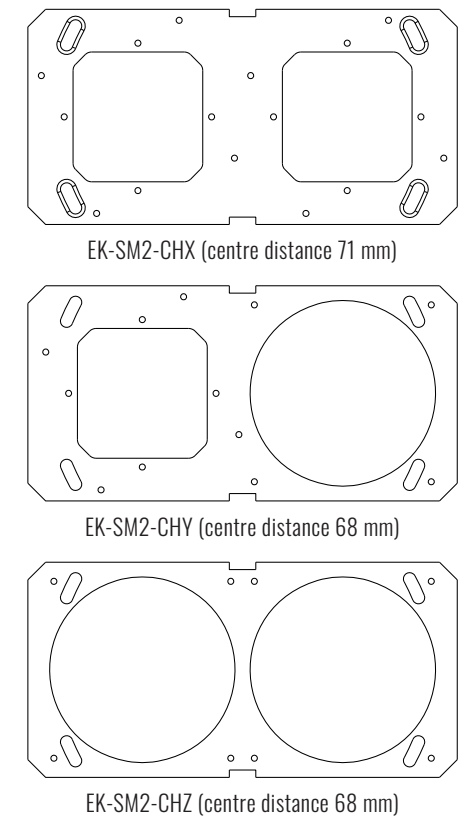

Order information

Code	Installation	Description
EK-SM1-CHS	single	Replacement metal support for (Feller 60 x 60 mm) single socket
EK-SM1-CHT		Replacement metal support for (Feller 60 x 60 mm) triple socket
EK-SM2-CHX	double horizontal/vertical	2 seats for Ekinex® 20venti or 71 series devices
EK-SM2-CHY		1 seat for Ekinex® 20venti or 71 series device 1 seat for 1 single socket (Feller 60 x 60 mm)
EK-SM2-CHZ		2 seats for sockets (Feller 60 x 60 mm)

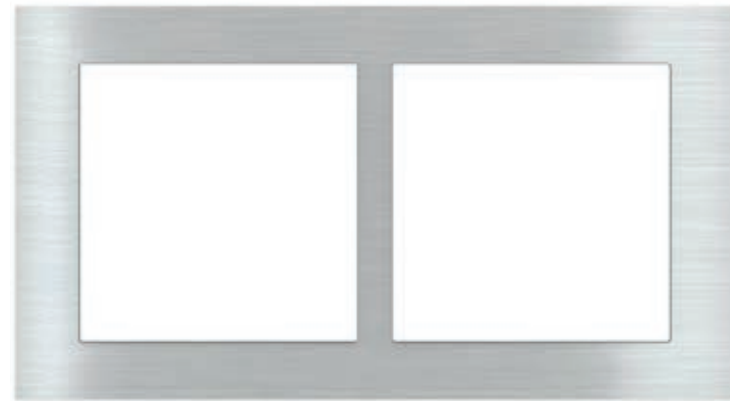

Double plate with 68 or 71 mm centre distance window

WALL-MOUNT DEVICES

Description

Double plate with 60 x 60 mm windows for mounting two power sockets (Feller) at 68 mm centre distance, an Ekinex® 20venti or 71 series device and a power socket (Feller) and for mounting two Ekinex® 20venti or 71 series devices at 71 mm centre distance. Round box components must be 60 x 60 mm in size.

Main features

- In aluminium, Metal HT or Fenix NTM®
- Snap-on mounting on adapter

Order information

Code	Windows L x H [mm]	For use with	Package
EK-P2H-... (NF)**	60 x 60	mounting with centre distance 68 mm	1 pcs.
EK-D2H-... (Deep)*			
EK-P2S-... (NF)	60 x 60	mounting with centre distance 71 mm	1 pcs.
EK-D2S-... (Deep)			

For mounting P2H and D2H: please order adapter separately (see next page).

*) Not available in Plastic

***) Not available in Plastic and Metal HT

Order

Base-codes must be completed by adding extensions for material, colour and finishing (3 characters).

Dimensions [mm]

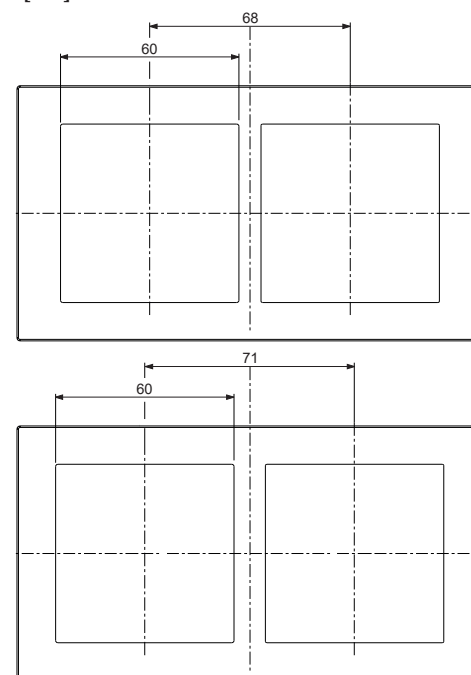

Description

Adapter for snap-on mounting of a square plate together with a power socket (Feller).

Main features

- In plastic material

Adapter for square plate and power socket (Feller)

WALL-MOUNT DEVICES

Order information

Code	For use with	Side profile	Package
EK-TAQ-1-CH	square plate with Form or Flank frame or without frame (*NF or Deep version) and a power socket (Feller)	black	1 pcs.

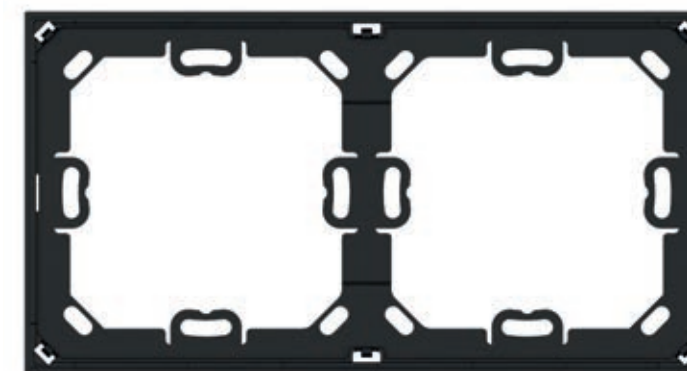

Description

Adapter for snap-on mounting of a double plate.

Main features

- In plastic material

Adapter for double plate

WALL-MOUNT DEVICES



Order information

Code	For use with	Side profile	Package
EK-A71	double plate with a Form or Flank frame	black	1 pcs.
EK-A71-1-NF	double plate of 71 series without frame (*NF version)		



Material and finishes

WALL-MOUNT DEVICES

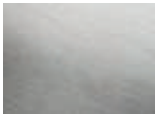
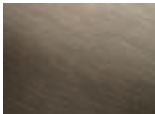
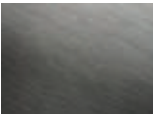
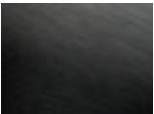

METAL HT (customisation of texts/symbols with laser marking)

			
CRO Chrome	GBM Black Metal	COP Copper coming soon	CHA Champagne
Plates Signum 20venti 71 Deep and Surface	Plates Signum 20venti 71 Deep and Surface	Plates Signum 20venti 71 Deep and Surface	Plates Signum 20venti 71 Deep and Surface
Rockers FF 71	Rockers FF 71	Rockers FF 71	Rockers FF 71







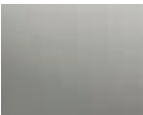

BRUSHED METAL (customisation of texts/symbols with laser marking)

				
GBQ Aluminium brushed finishing	GBR Nickel brushed finishing	GBS Titanium brushed finishing	GBU Carbon brushed finishing	GBB Brass brushed finishing
Frames FF-71 Form FF-71 Flank	Frames FF-71 Form FF-71 Flank	Frames FF-71 Form FF-71 Flank	Frames FF-71 Form FF-71 Flank	Frames FF-71 Form FF-71 Flank
Plates Signum 20venti 71	Plates Signum 20venti 71	Plates Signum 20venti 71	Plates Signum 20venti 71	Plates Signum 20venti 71
Rockers FF 71	Rockers FF 71	Rockers FF 71	Rockers FF 71	Rockers FF 71

PLASTIC (customisation of texts/symbols with UV printing)

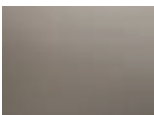
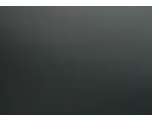
		
GAA White	GAE Intense black RAL 9005	GAG Silver metallic plastic
Frames FF-71 Form FF-71 Flank	Frames FF-71 Form FF-71 Flank	Frames FF-71 Form FF-71 Flank
Plates 20venti Deep 71 *NF and Deep	Plates 20venti Deep 71 *NF and Deep	Plates 20venti Deep 71 *NF and Deep
Rockers 20venti FF	Rockers 20venti FF	Rockers 20venti FF

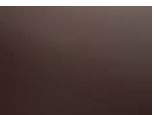
FENIX NTM® (customisation of texts/symbols with UV printing)

								
FBM White Malé	FBL Beige Luxor	FCO Beaver Ottawa	FGE Grey Efeso	FGL Grey London	FGB Grey Bromine	FVC Green Commodore	FCC Cocoa Orinoco	FNI Black Ingo
Plates Signum 20venti 71	Plates Signum 20venti 71	Plates Signum 20venti 71	Plates Signum 20venti 71	Plates Signum 20venti 71	Plates Signum 20venti 71	Plates Signum 20venti 71	Plates Signum 20venti 71	Plates Signum 20venti 71
Rockers FF 71	Rockers FF 71	Rockers FF 71	Rockers FF 71	Rockers FF 71	Rockers FF 71	Rockers FF 71	Rockers FF 71	Rockers FF 71

* ON REQUEST
The range finishes shown on the left are the result of a company stylistic choice. Additional finishes in Fenix NTM® and metal are also available upon request (non-standard processes may be subject to limitation).















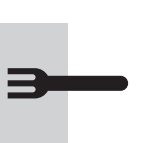

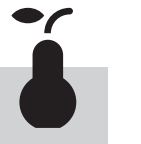

Ekinex chooses Fenix NTM®

WALL-MOUNT DEVICES

A super opaque nanotech material, is an innovative interior design product, that combines elegant aesthetic solutions with state-of-the-art technological performance.

Fenix NTM® is an innovative interior design product, that combines elegant aesthetic solutions with state-of-the-art technological performance. The external surface involves the use of nanotechnology and it is characterized by next generation acrylic resins, hardened and fixed with Electron Beam Curing process opening up new avenues in the field of interior design. With low light reflectivity, its surface is extremely opaque, anti-fingerprint and features a very pleasant soft touch.

More information:
ekinex.com/en/material-and-finishes/fenix-ntm.html

				
Low light reflectivity	Thermal healing of micro scratches	Anti-fingerprint	Soft touch	Resistance to scratches and abrasion
				
Resistance to dry heat	High resistance to acid solvents and household reagents	Enhanced anti-bacterial properties	Hygienic	Suitable for contact with food
				
Easy to clean	Mold-resistant	Antistatic	Hydro-repellent	Dimensional stability even at high temperature changes
				
Resistance to impact	Light fastness	Excellent intensity and colour depth	Rub resistance	Self-supporting (only for 10 and 12 mm)

Rockers for devices of 20venti, FF and 71 series can be customized with symbols from the library on the following pages. Upon request, it is also possible to customize rockers with symbols and text provided by the customer.

Symbols for rockers customization

WALL-MOUNT DEVICES

Square rockers

The code extension includes 3 characters identifying material, colour and finishing and 3 more characters identifying symbols. Within the last 3-character group, the first character identifies a double symbol, while the second and third characters identify a single symbol.

Single symbol

The single symbol is reproduced in the central part of the square rocker, centred both horizontally and vertically. If the second and third characters of the extension-code equal "0", the rocker has no single symbol.

Double symbol

The double symbol is reproduced in the upper and lower part of the square rocker, both centred horizontally. If the first character in the extension-code equals "0", the rocker has no double symbol.

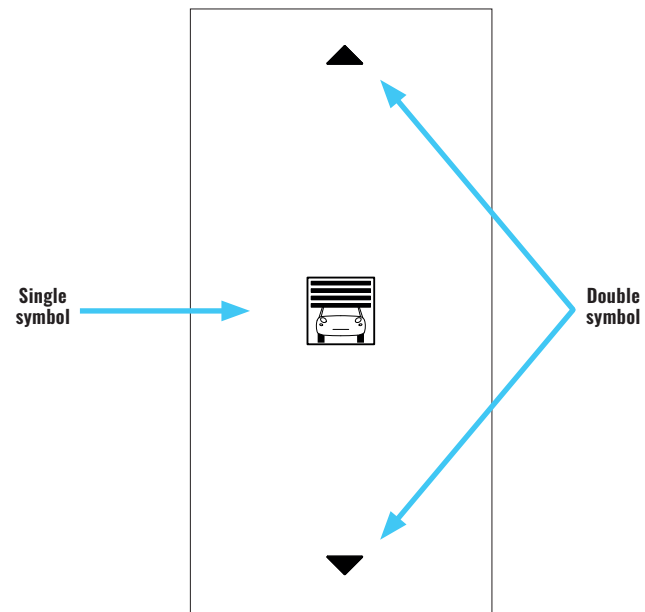
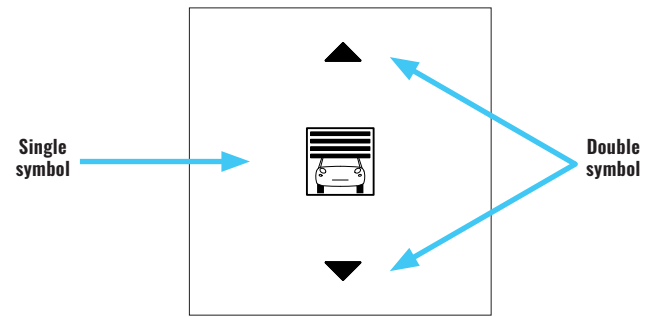

Vertical rectangular rockers

The code extension includes 3 characters identifying material, colour and finishing and 3 more characters identifying symbols. Within the last 3-character group, the first character identifies a double symbol, while the second and third characters identify a single symbol.

Single symbol

The single symbol is reproduced in the central part of the rectangular rocker, centred both horizontally and vertically. If the second and third characters of the extension-code equal "0", the rocker has no single symbol.

Double symbol

The double symbol is reproduced in the upper and lower part of the rectangular rocker, both centred horizontally. If the first character in the extension-code equals "0", the rocker has no double symbol.

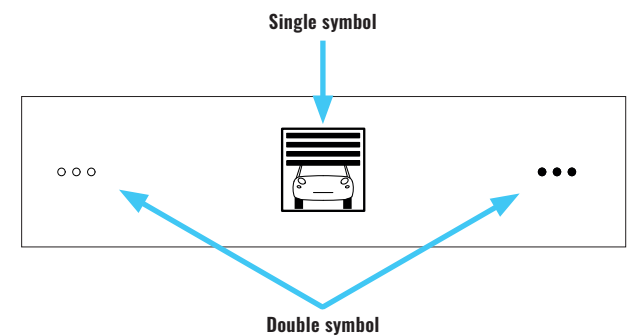

Horizontal rectangular rockers

The code extension includes 3 characters identifying material, colour and finishing and 3 more characters identifying symbols. Within the last 3-character group, the first character identifies a double symbol, while the second and third characters identify a single symbol.

Single symbol

The single symbol is reproduced in the central part of the rectangular rocker, centred both horizontally and vertically. If the second and third characters of the extension-code equal "0", the rocker has no single symbol.

Double symbol

The double symbol is reproduced on the left and right sides of the rectangular rocker, vertically centred. If the first character in the extension-code equals "0", the rocker has no double symbol.

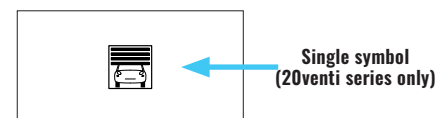

Single symbols



NS00 No symbol

Lighting

LI01 Dimming	LI02 Floor lamp	LI03 Wall lamp	LI04 Ceiling light pendant	LI05 Spotlight	LI06 Staircase lamp	LI07 Outdoor lighting	LI08 Ceiling light
LI09 Lighting scene	LI10 Wall lamp	LI11 Floor lamp On	LI12 Floor lamp Off	LI13 External light	LI14 General lamp	LI15 Spotlight pendant	LI16 Bulb light

Multimedia

MU01 Projector screen	MU02 Loudspeaker	MU03 Loudspeaker 2	MU04 Music On	MU05 Sound system	MU06 Sound system 2	MU07 Play	MU08 Stop
MU09 Pause	MU010 Rew	MU011 FFwd	MU012 TV	MU013 Wi-fi			

Health and care

HC01 Buzzer	HC02 Disabled	HC03 First aid	HC04 Disabled 2	HC05 WC Women	HC06 WC Man

Door and garage

D001 Garage open	D002 Gate	D003 Barrier	D004 Pedestrian entrance	D005 Roller, blind	D006 Internal curtain	D007 External curtain	D008 Door lock
D009 Unlock	D0010 Lock	D0011 Roof light windows open	D0012 Roof light window closed	D0013 External curtain 2	D0014 Garage closed	D0015 Garage open	D0016 Curtains open
D0017 Window closed	D0018 Window open	D0019 Roller, blind open	D0020 Roller, blind open (50%)	D0021 Roller, blind closed	D0022 Mosquito net	D0023 Curtain with embrasse	D0024 Door lock 2

Hotel

H001 Room service	H002 Service	H004 Make up room	H005 Hotel Card	H008 Do not disturb card	H008 Make up room 2	H009 Make up room 3	H010 Make up room 4

Energy

EN01 Power Off	EN02 Power On	EN03 Electric load	EN04 Portable electric load	EN05 Electric socket On/Off	EN06 Electric socket	EN07 Led socket
EN08 Car recharge	EN09 Recharge	EN010 Bicycle recharge	EN011 Washing machine	EN012 Dishwasher		

* Not available for 20venti series with backlit texts and symbols

Climate

CL01 Temperature	CL02 Temperature increase	CL03 Temperature reduction	CL04 Fan	CL05 Fan speed 1	CL06 Fan speed 2	CL07 Fan speed 3	CL08 Humidity
CL09 Radiator							

Scenarios

SC01 Comfort scenarios	SC02 External light scenarios	SC03 Manual scenarios	SC04 Night scenarios	SC05 Scenarios Off	SC06 Scenarios On	SC07 Roller opening scenarios	SC08 Roller closing scenarios
SC09 Curtains opening scenarios	SC10 Curtains closing scenarios	SC11 Party scenarios	SC12 Presence scenarios	SC13 Standby scenarios	SC14 Day scenarios On	SC15 Day scenarios Off	SC16 Presence
SC17 Presence 2	SC18 No presence scenarios	SC19 Irrigation scenarios	SC20 Clock				

Markers

MA01 Increment (full arrow)	MA02 Decrement (full arrow)	MA03 Increment (empty arrow)	MA04 Decrement (empty arrow)
MA05 Increment (simple arrow)	MA06 Decrement (simple arrow)	MA05 Increment (plus)	MA06 Decrement (minus)

Status Led (20venti)

MA09 Status Led

Note. For convenience, all the symbols in this page are shown as they appear on square rockers. The same symbols may also be requested for rectangular rockers. The symbols shown here can be replaced by customised symbols or text on request.

Double symbols

NS00 No symbol	DM01 Simple arrow	DM02 Arrow (empty)	DM03 Arrow (empty/full)	DM04 Arrow (full)	DM05 On/Off	DM06 Bullets (empty)	DM07 Bullets (empty/full)
DM08 On/Off (I/O)	DM09 Plus / minus	DM10 Speed 1	DM11 Speed 2	DM12 Speed 3	DM13 Triple bullets (empty/full)	DM14 Volume	
DM15 Triple bullets (empty/full)	DM16 On/Off	DM17 On/Off (I/O)	DM18 Plus / minus				
DM19 Simple arrow	DM20 Arrow (empty)	DM21 Volume	DM22 Bullets (empty/full)				
DM23 Arrow (empty/full)							

Customization with text

WALL-MOUNT DEVICES

Square rockers can be customized with text to be shown in the upper, central or lower areas. Texts must be specified at order time.

Text added to upper area only (max 12 characters)	Text added to lower area only (max. 12 characters)	Text added to both upper and lower areas (max. 12 chars each)	Text added to central area only (1 or 2 lines, max. 12 chars each)

Horizontal rectangular rockers can be customized by means of text in their central area.

Text added to central area only (1 or 2 lines, max. 12 chars each)	Text added to central area only (max. 11 chars each) 20venti series only

Vertical rectangular rockers can be customized with text to be shown in the upper, central or lower areas.

	Text added to upper area (max. 12 chars each)
	Text added to central area (1 or 2 lines, max. 12 chars each)
	Text added to lower area (max. 12 chars each)

How to order a rocker

Rockers for pushbuttons 20venti series

WALL-MOUNT DEVICES

Rockers for 4-fold pushbutton 20venti series.

The ordering code of a rocker is formed by a fixed part (EK-T) plus a variable part which represents modularity, material, colour, finishing and customization codes as shown in symbol library.

PLASTIC MATERIAL

Modularity	Colour	Code
	white	EK-T4R-20-GAA
rectangular backlit text/symbols (4 rockers 30 x 15 mm)	intense black RAL 9005	EK-T4R-20-GAE
	silver	EK-T4R-20-GAG
	white	EK-T2B-20-GAA
	intense black RAL 9005	EK-T2B-20-GAE
	silver	EK-T2B-20-GAG

METAL-EFFECT PAINTING

Modularity	Colour	Code
	aluminium	EK-T4R-20-GBQ
	nickel	EK-T4R-20-GBR
	titanium	EK-T4R-20-GBS
	carbon	EK-T4R-20-GBU
	brass	EK-T4R-20-GBB
	aluminium	EK-T2B-20-GBQ
	nickel	EK-T2B-20-GBR
	titanium	EK-T2B-20-GBS
	carbon	EK-T2B-20-GBU
	brass	EK-T2B-20-GBB

FENIX NTM®-EFFECT PAINTING

Modularity	Colour	Code
	malè white	EK-T4R-20-FBM
	beige luxor	EK-T4R-20-FBL
	beaver ottawa	EK-T4R-20-FCO
	cocoa orinoco	EK-T4R-20-FCC
	grey efeso	EK-T4R-20-FGE
	grey london	EK-T4R-20-FGL
	grey bromine	EK-T4R-20-FGB
	green commodore	EK-T4R-20-FVC
	black ingo	EK-T4R-20-FNI
		malè white
beige luxor		EK-T2B-20-FBL
beaver ottawa		EK-T2B-20-FCO
cocoa orinoco		EK-T2B-20-FCC
grey efeso		EK-T2B-20-FGE
grey london		EK-T2B-20-FGL
grey bromine		EK-T2B-20-FGB
green commodore		EK-T2B-20-FVC
black ingo		EK-T2B-20-FNI

Rockers for pushbuttons FF series

WALL-MOUNT DEVICES

Rockers for 4-fold pushbutton FF series.

The ordering code of a rocker is formed by a fixed part (EK-T) plus a variable part which represents modularity, material, colour, finishing and customization codes as shown in symbol library.

PLASTIC MATERIAL

Modularity	Colour	Finishing	Code
	white		EK-TQQ-GAA
	intense black RAL 9005		EK-TQQ-GAE
square	silver		EK-TQQ-GAG
	white	normal	EK-TRV-GAA
	intense black RAL 9005		EK-TRV-GAE
	silver		EK-TRV-GAG
rectangular (vertical)	white		EK-TRO-GAA
	intense black RAL 9005		EK-TRO-GAE
rectangular (horizontal)	white		EK-TRO-GAG
	intense black RAL 9005		EK-TRO-GAG

ALUMINIUM

Modularity	Colour	Finishing	Code
	aluminium		EK-TQQ-GBQ
	nickel		EK-TQQ-GBR
	titanium		EK-TQQ-GBS
	carbon		EK-TQQ-GBU
	brass		EK-TQQ-GBB
square	aluminium		EK-TRV-GBQ
	nickel	brushed	EK-TRV-GBR
	titanium		EK-TRV-GBS
	carbon		EK-TRV-GBU
	brass		EK-TRV-GBB
rectangular (vertical)	aluminium		
	nickel		EK-TRO-GBR
	titanium		EK-TRO-GBS
	carbon		EK-TRO-GBU
	brass		EK-TRO-GBB
rectangular (horizontal)	aluminium		EK-TRO-GBQ
	nickel		EK-TRO-GBR
	titanium		EK-TRO-GBS
	carbon		EK-TRO-GBU
	brass		EK-TRO-GBB

FENIX NTM®

Modularity	Colour	Code
	malè white	EK-TQQ-FBM
	beige luxor	EK-TQQ-FBL
	beaver ottawa	EK-TQQ-FCO
	cocoa orinoco	EK-TQQ-FCC
	grey efeso	EK-TQQ-FGE
	grey london	EK-TQQ-FGL
	grey bromine	EK-TQQ-FGB
	green commodore	EK-TQQ-FVC
	black ingo	EK-TQQ-FNI
	square	malè white
beige luxor		EK-TRV-FBL
beaver ottawa		EK-TRV-FCO
cocoa orinoco		EK-TRV-FCC
grey efeso		EK-TRV-FGE
grey london		EK-TRV-FGL
grey bromine		EK-TRV-FGB
green commodore		EK-TRV-FVC
black ingo		EK-TRV-FNI
rectangular vertical		malè white
	beige luxor	EK-TRO-FBL
	beaver ottawa	EK-TRO-FCO
	cocoa orinoco	EK-TRO-FCC
	grey efeso	EK-TRO-FGE
	grey london	EK-TRO-FGL
	grey bromine	EK-TRO-FGB
	green commodore	EK-TRO-FVC
	black ingo	EK-TRO-FNI
	rectangular horizontal	malè white
beige luxor		EK-TRO-FBL
beaver ottawa		EK-TRO-FCO
cocoa orinoco		EK-TRO-FCC
grey efeso		EK-TRO-FGE
grey london		EK-TRO-FGL
grey bromine		EK-TRO-FGB
green commodore		EK-TRO-FVC
black ingo		EK-TRO-FNI

METAL HT

Modularity	Colour	Finishing	Code
	Chrome	chrome plated	EK-TQQ-CRO
	Black Metal		EK-TQQ-CBM
	Copper		EK-TQQ-COP
	Champagne		EK-TQQ-CHA
square	Chrome		EK-TRV-CRO
rectangular (vertical)	Black Metal		EK-TRV-CBM
	Copper		EK-TRV-COP
	Champagne		EK-TRV-CHA
rectangular (horizontal)	Chrome		EK-TRO-CRO
	Black Metal		EK-TRO-CBM
	Copper		EK-TRO-COP
	Champagne		EK-TRO-CHA

Kit 2 rockers for room thermostats FF series

WALL-MOUNT DEVICES

PLASTIC MATERIAL

Modularity	Colour	Finishing	Code
	white	normal	EK-TQQ-GAA-EP2
	intense black RAL 9005		EK-TQQ-GAE-EP2
	silver		EK-TQQ-GAG-EP2
	square		

Note. The kit includes 2 rockers customized with symbols for the control of thermostats functions.

ALUMINIUM

Modularity	Colour	Finishing	Code
	aluminium	brushed	EK-TQQ-GBQ-EP2
	nickel		EK-TQQ-GBR-EP2
	titanium		EK-TQQ-GBS-EP2
	carbon		EK-TQQ-GBU-EP2
	brass		EK-TQQ-GBB-EP2
square			

Note. The kit includes 2 rockers customized with symbols for the control of thermostats functions.

METAL HT

Modularity	Colour	Finishing	Code
	Chrome	chrome plated	EK-TQQ-CRO-EP2
	Black Metal		EK-TQQ-CBM-EP2
	Copper		EK-TQQ-COP-EP2
	Champagne		EK-TQQ-CHA-EP2
square			

Note. The kit includes 2 rockers customized with symbols for the control of thermostats functions.

FENIX NTM®

Modularity	Colour	Code
	malè white	EK-TQQ-FBM-EP2
	beige luxor	EK-TQQ-FBL-EP2
	beaver ottawa	EK-TQQ-FCO-EP2
	cocoa orinoco	EK-TQQ-FCC-EP2
	grey efeso	EK-TQQ-FGE-EP2
	grey london	EK-TQQ-FGL-EP2
	grey bromine	EK-TQQ-FGB-EP2
	green commodore	EK-TQQ-FVC-EP2
	black ingo	EK-TQQ-FNI-EP2
	square	

Note. The kit includes 2 rockers customized with symbols for the control of thermostats functions.

Rockers for pushbuttons 71 series

WALL-MOUNT DEVICES

Rockers for 4-fold pushbutton 71 series.

The ordering code of a rocker is formed by a fixed part (EK-T) plus a variable part which represents modularity, material, colour, finishing and customization codes as shown in symbol library.

PLASTIC MATERIAL

Modularity	Colour	Finishing	Code
square (1 rocker 60 x 60 mm)	white	normal	EK-T1Q-GAA
	intense black RAL 9005		EK-T1Q-GAE
	silver		EK-T1Q-GAG
rectangular vertical (2 rockers 30 x 60 mm)	white		EK-T2R-GAA
	intense black RAL 9005		EK-T2R-GAE
	silver		EK-T2R-GAG
square (4 rockers 30 x 30 mm)	white	EK-T4Q-GAA	
	intense black RAL 9005	EK-T4Q-GAE	
	silver	EK-T4Q-GAG	
rectangular horizontal (4 rockers 60 x 15 mm)	white	EK-T4R-GAA	
	intense black RAL 9005	EK-T4R-GAE	
	silver	EK-T4R-GAG	

METAL

Modularity	Colour	Finishing	Code
square (1 rocker 60 x 60 mm)	aluminium		EK-T1Q-GBQ
	nickel		EK-T1Q-GBR
	titanium		EK-T1Q-GBS
	carbon		EK-T1Q-GBU
	brass		EK-T1Q-GBB
rectangular vertical (2 rockers 30 x 60 mm)	aluminium		EK-T2R-GBQ
	nickel		EK-T2R-GBR
	titanium		EK-T2R-GBS
	carbon		EK-T2R-GBU
	brass		EK-T2R-GBB
square (4 rockers 30 x 30 mm)	aluminium	brushed	EK-T4Q-GBQ
	nickel		EK-T4Q-GBR
	titanium		EK-T4Q-GBS
	carbon		EK-T4Q-GBU
	brass		EK-T4Q-GBB
rectangular horizontal (4 rockers 60 x 15 mm)	aluminium		EK-T4R-GBQ
	nickel		EK-T4R-GBR
	titanium		EK-T4R-GBS
	carbon		EK-T4R-GBU
	brass		EK-T4R-GBB

METAL HT

Modularity	Colour	Finishing	Code
square (1 rocker 60 x 60 mm)	Chrome		EK-T1Q-CRO
	Black Metal		EK-T1Q-CBM
	Copper		EK-T1Q-COP
	Champagne		EK-T1Q-CHA
rectangular vertical (2 rockers 30 x 60 mm)	Chrome		EK-T2R-CRO
	Black Metal		EK-T2R-CBM
	Copper		EK-T2R-COP
	Champagne		EK-T2R-CHA
square (4 rockers 30 x 30 mm)	Chrome	chrome plated	EK-T4Q-CRO
	Black Metal		EK-T4Q-CBM
	Copper		EK-T4Q-COP
	Champagne		EK-T4Q-CHA
rectangular horizontal (4 rockers 60 x 15 mm)	Chrome		EK-T4R-CRO
	Black Metal		EK-T4R-CBM
	Copper		EK-T4R-COP
	Champagne		EK-T4R-CHA

FENIX NTM®

Modularity	Colour	Code
square (1 rocker 60 x 60 mm)	malè white	EK-T1Q-FBM
	beige luxor	EK-T1Q-FBL
	beaver ottawa	EK-T1Q-FCO
	cocoa orinoco	EK-T1Q-FCC
	grey efeso	EK-T1Q-FGE
	grey london	EK-T1Q-FGL
	grey bromine	EK-T1Q-FGB
	green commodore	EK-T1Q-FVC
	black ingo	EK-T1Q-FNI
	rectangular vertical (2 rockers 30 x 60 mm)	malè white
beige luxor		EK-T2R-FBL
beaver ottawa		EK-T2R-FCO
cocoa orinoco		EK-T2R-FCC
grey efeso		EK-T2R-FGE
grey london		EK-T2R-FGL
grey bromine		EK-T2R-FGB
green commodore		EK-T2R-FVC
black ingo		EK-T2R-FNI
square (4 rockers 30 x 30 mm)		malè white
	beige luxor	EK-T4Q-FBL
	beaver ottawa	EK-T4Q-FCO
	cocoa orinoco	EK-T4Q-FCC
	grey efeso	EK-T4Q-FGE
	grey london	EK-T4Q-FGL
	grey bromine	EK-T4Q-FGB
	green commodore	EK-T4Q-FVC
	black ingo	EK-T4Q-FNI
	rectangular horizontal (4 rockers 60 x 15 mm)	malè white
beige luxor		EK-T4R-FBL
beaver ottawa		EK-T4R-FCO
cocoa orinoco		EK-T4R-FCC
grey efeso		EK-T4R-FGE
grey london		EK-T4R-FGL
grey bromine		EK-T4R-FGB
green commodore		EK-T4R-FVC
black ingo	EK-T4R-FNI	

How to order a front cover

Multisensors

WALL-MOUNT DEVICES

Front cover - Multisensors

The ordering code of a rocker is formed by a fixed part (EK-T) plus a variable part which represents modularity, material, colour, finishing and model.

PLASTIC MATERIAL

Modularity	Colour	Finishing	Code
 Front cover Multisensor (60 x 60 mm)	white	normal	EK-T1Q-GAA-ET2 EK-T1Q-GAA-ES2
	intense black RAL 9005		EK-T1Q-GAE-ET2 EK-T1Q-GAE-ES2
	silver		EK-T1Q-GAG-ET2 EK-T1Q-GAG-ES2

METAL

Modularity	Colour	Finishing	Code
 Front cover Multisensor (60 x 60 mm)	aluminium	brushed	EK-T1Q-GBQ-ET2 EK-T1Q-GBQ-ES2
	nickel		EK-T1Q-GBR-ET2 EK-T1Q-GBR-ES2
	titanium		EK-T1Q-GBS-ET2 EK-T1Q-GBS-ES2
	carbon		EK-T1Q-GBU-ET2 EK-T1Q-GBU-ES2
	brass		EK-T1Q-GBB-ET2 EK-T1Q-GBB-ES2

FENIX NTM®

Modularity	Colour	Finishing	Code
 Front cover Multisensor (60 x 60 mm)	malè white	EK-T1Q-FBM-ET2	EK-T1Q-FBM-ES2
	beige luxor	EK-T1Q-FBL-ET2	EK-T1Q-FBL-ES2
	beaver ottawa	EK-T1Q-FCO-ET2	EK-T1Q-FCO-ES2
	cocoa orinoco	EK-T1Q-FCC-ET2	EK-T1Q-FCC-ES2
	grey efeso	EK-T1Q-FGE-ET2	EK-T1Q-FGE-ES2
	grey london	EK-T1Q-FGL-ET2	EK-T1Q-FGL-ES2
	grey bromine	EK-T1Q-FGB-ET2	EK-T1Q-FGB-ES2
	green commodore	EK-T1Q-FVC-ET2	EK-T1Q-FVC-ES2
	black ingo	EK-T1Q-FNI-ET2	EK-T1Q-FNI-ES2

METAL HT

Modularity	Colour	Finishing	Code
 Front cover Multisensor (60 x 60 mm)	Chrome	chrome plated	EK-T1Q-CRO-ET2 EK-T1Q-CRO-ES2
	Black Metal		EK-T1Q-CBM-ET2 EK-T1Q-CBM-ES2
	Copper		EK-T1Q-COP-ET2 EK-T1Q-COP-ES2
	Champagne		EK-T1Q-CHA-ET2 EK-T1Q-CHA-ES2

Keystone system

WALL-MOUNT DEVICES

Keystone cover.

The ordering code of a rocker is formed by a fixed part (EK-KSC) plus a variable part which represents modularity, material, colour and finishing.

PLASTIC MATERIAL

Modularity	Colour	Code
 Keystone cover (55 x 55 mm)	white	EK-KSC-1-GAA EK-KSC-2-GAA
	intense black RAL 9005	EK-KSC-1-GAE EK-KSC-2-GAE
	silver	EK-KSC-1-GAG EK-KSC-2-GAG

METAL-EFFECT PAINTING

Modularity	Colour	Code
 Keystone cover (55 x 55 mm)	aluminium	EK-KSC-1-GBQ EK-KSC-2-GBQ
	nickel	EK-KSC-1-GBR EK-KSC-2-GBR
	titanium	EK-KSC-1-GBS EK-KSC-2-GBS
	carbon	EK-KSC-1-GBU EK-KSC-2-GBU
	brass	EK-KSC-1-GBB EK-KSC-2-GBB

METAL HT

Modularity	Colour	Finishing	Code
 Keystone cover (55 x 55 mm)	Chrome	chrome plated	EK-KSC-1-CRO EK-KSC-2-CRO
	Black Metal		EK-KSC-1-CBM EK-KSC-2-CBM
	Copper		EK-KSC-1-COP EK-KSC-2-COP
	Champagne		EK-KSC-1-CHA EK-KSC-2-CHA

FENIX NTM®-EFFECT PAINTING

Modularity	Colour	Code
 Keystone cover (55 x 55 mm)	malè white	EK-KSC-1-FBM EK-KSC-2-FBM
	beige luxor	EK-KSC-1-FBL EK-KSC-2-FBL
	beaver ottawa	EK-KSC-1-FCO EK-KSC-2-FCO
	cocoa orinoco	EK-KSC-1-FCC EK-KSC-2-FCC
	grey efeso	EK-KSC-1-FGE EK-KSC-2-FGE
	grey london	EK-KSC-1-FGL EK-KSC-2-FGL
	grey bromine	EK-KSC-1-FGB EK-KSC-2-FGB
	green commodore	EK-KSC-1-FVC EK-KSC-2-FVC
	black ingo	EK-KSC-1-FNI EK-KSC-2-FNI

Hole cover

WALL-MOUNT DEVICES

Hole cover.

The ordering code of a rocker is formed by a fixed part (EK-A55) plus a variable part which represents modularity, material, colour and finishing.

PLASTIC MATERIAL

Modularity	Colour	Code
 Hole cover (55 x 55 mm)	white	EK-A55-GAA
	intense black RAL 9005	EK-A55-GAE
	silver	EK-A55-GAG

METAL-EFFECT PAINTING

Modularity	Colour	Code
 Hole cover (55 x 55 mm)	aluminium	EK-A55-GBQ
	nickel	EK-A55-GBR
	titanium	EK-A55-GBS
	carbon	EK-A55-GBU
	brass	EK-A55-GBB

METAL HT

Modularity	Colour	Finishing	Code
 Hole cover (55 x 55 mm)	Chrome	chrome plated	EK-A55-CRO
	Black Metal		EK-A55-CBM
	Copper		EK-A55-COP
	Champagne		EK-A55-CHA

FENIX NTM®-EFFECT PAINTING

Modularity	Colour	Code
 Hole cover (55 x 55 mm)	malè white	EK-A55-FBM
	beige luxor	EK-A55-FBL
	beaver ottawa	EK-A55-FCO
	cocoa orinoco	EK-A55-FCC
	grey efeso	EK-A55-FGE
	grey london	EK-A55-FGL
	grey bromine	EK-A55-FGB
	green commodore	EK-A55-FVC
	black ingo	EK-A55-FNI

Power sockets

WALL-MOUNT DEVICES

PLASTIC MATERIAL

Version	Dimensions	Colour	Finishing	Code
Italian	55 x 55 mm	white	normal	EK-PSC-IT-GAA
		Intense black RAL 9005		EK-PSC-IT-GAE
		silver		EK-PSC-IT-GAG
UK	55 x 55 mm	white		EK-PSC-UK-GAA
		Intense black RAL 9005		EK-PSC-UK-GAE
		silver		EK-PSC-UK-GAG

METAL-EFFECT PAINTING

Version	Dimensions	Colour	Code
Italian	55 x 55 mm	aluminium	EK-PSC-IT-GBQ
		nickel	EK-PSC-IT-GBR
		titanium	EK-PSC-IT-GBS
		carbon	EK-PSC-IT-GBU
		brass	EK-PSC-IT-GBB
UK	55 x 55 mm	aluminium	EK-PSC-UK-GBQ
		nickel	EK-PSC-UK-GBR
		titanium	EK-PSC-UK-GBS
		carbon	EK-PSC-UK-GBU
		brass	EK-PSC-UK-GBB

METAL HT

Version	Dimensions	Colour	Code
Italian	55 x 55 mm	Chrome	EK-PSC-IT-CRO
		Black Metal	EK-PSC-IT-CBM
		Copper	EK-PSC-IT-COP
		Champagne	EK-PSC-IT-CHA
UK	55 x 55 mm	Chrome	EK-PSC-UK-CRO
		Black Metal	EK-PSC-UK-CBM
		Copper	EK-PSC-UK-COP
		Champagne	EK-PSC-UK-CHA

FENIX NTM®-EFFECT PAINTING

Version	Dimensions	Colour	Code		
Italian	55 x 55 mm	malè white	EK-PSC-IT-FBM		
		beige luxor	EK-PSC-IT-FBL		
		beaver ottawa	EK-PSC-IT-FCO		
		cocoa orinoco	EK-PSC-IT-FCC		
		grey efeso	EK-PSC-IT-FGE		
		grey london	EK-PSC-IT-FGL		
		grey bromine	EK-PSC-IT-FGB		
		green commodore	EK-PSC-IT-FVC		
		black ingo	EK-PSC-IT-FNI		
		UK	55 x 55 mm	malè white	EK-PSC-UK-FBM
				beige luxor	EK-PSC-UK-FBL
beaver ottawa	EK-PSC-UK-FCO				
cocoa orinoco	EK-PSC-UK-FCC				
grey efeso	EK-PSC-UK-FGE				
grey london	EK-PSC-UK-FGL				
grey bromine	EK-PSC-UK-FGB				
green commodore	EK-PSC-UK-FVC				
black ingo	EK-PSC-UK-FNI				

Power socket

The ordering code for the coloured cover of an electrical socket is formed by a fixed part (EK-PSC) and a variable part depending on the version (Italian or Schuko) and the colour. The ordering code for the power socket body only is EK-PWS-. (IT - DE - FR - UK).

PLASTIC MATERIAL

Version	Dimensions	Colour	Finishing	Code
Schuko	55 x 55 mm	white	normal	EK-PSC-DE-GAA
		Intense black RAL 9005		EK-PSC-DE-GAE
		silver		EK-PSC-DE-GAG
French	55 x 55 mm	white		EK-PSC-FR-GAA
		Intense black RAL 9005		EK-PSC-FR-GAE
		silver		EK-PSC-FR-GAG

METAL-EFFECT PAINTING

Version	Dimensions	Colour	Code
Schuko	55 x 55 mm	aluminium	EK-PSC-FR-GBQ
		nickel	EK-PSC-FR-GBR
		titanium	EK-PSC-FR-GBS
		carbon	EK-PSC-FR-GBU
		brass	EK-PSC-FR-GBB
French	55 x 55 mm	aluminium	EK-PSC-FR-GBQ
		nickel	EK-PSC-FR-GBR
		titanium	EK-PSC-FR-GBS
		carbon	EK-PSC-FR-GBU
		brass	EK-PSC-FR-GBB

METAL HT

Version	Dimensions	Colour	Code
Schuko	55 x 55 mm	Chrome	EK-PSC-DE-CRO
		Black Metal	EK-PSC-DE-CBM
		Copper	EK-PSC-DE-COP
		Champagne	EK-PSC-DE-CHA
French	55 x 55 mm	Chrome	EK-PSC-FR-CRO
		Black Metal	EK-PSC-FR-CBM
		Copper	EK-PSC-FR-COP
		Champagne	EK-PSC-FR-CHA

FENIX NTM®-EFFECT PAINTING

Version	Dimensions	Colour	Code		
Schuko	55 x 55 mm	malè white	EK-PSC-DE-FBM		
		beige luxor	EK-PSC-DE-FBL		
		beaver ottawa	EK-PSC-DE-FCO		
		cocoa orinoco	EK-PSC-DE-FCC		
		grey efeso	EK-PSC-DE-FGE		
		grey london	EK-PSC-DE-FGL		
		grey bromine	EK-PSC-DE-FGB		
		green commodore	EK-PSC-DE-FVC		
		black ingo	EK-PSC-DE-FNI		
		French	55 x 55 mm	malè white	EK-PSC-FR-FBM
				beige luxor	EK-PSC-FR-FBL
beaver ottawa	EK-PSC-FR-FCO				
cocoa orinoco	EK-PSC-FR-FCC				
grey efeso	EK-PSC-FR-FGE				
grey london	EK-PSC-FR-FGL				
grey bromine	EK-PSC-FR-FGB				
green commodore	EK-PSC-FR-FVC				
black ingo	EK-PSC-FR-FNI				

Power sockets USB

WALL-MOUNT DEVICES

PLASTIC MATERIAL

Version	Dimensions	Colour	Finishing	Code
Italian	55 x 55 mm	white	normal	EK-PSC-IT-USB-GAA
		Intense black RAL 9005		EK-PSC-IT-USB-GAE
		silver		EK-PSC-IT-USB-GAG
UK	55 x 55 mm	white		EK-PSC-UK-USB-GAA
		Intense black RAL 9005		EK-PSC-UK-USB-GAE
		silver		EK-PSC-UK-USB-GAG

METAL-EFFECT PAINTING

Version	Dimensions	Colour	Code
Italian	55 x 55 mm	aluminium	EK-PSC-IT-USB-GBQ
		nickel	EK-PSC-IT-USB-GBR
		titanium	EK-PSC-IT-USB-GBS
		carbon	EK-PSC-IT-USB-GBU
		brass	EK-PSC-IT-USB-GBB
UK	55 x 55 mm	aluminium	EK-PSC-UK-USB-GBQ
		nickel	EK-PSC-UK-USB-GBR
		titanium	EK-PSC-UK-USB-GBS
		carbon	EK-PSC-UK-USB-GBU
		brass	EK-PSC-UK-USB-GBB

METAL HT

Version	Dimensions	Colour	Code
Italian	55 x 55 mm	Chrome	EK-PSC-IT-USB-CRO
		Black Metal	EK-PSC-IT-USB-CBM
		Copper	EK-PSC-IT-USB-COP
		Champagne	EK-PSC-IT-USB-CHA
UK	55 x 55 mm	Chrome	EK-PSC-UK-USB-CRO
		Black Metal	EK-PSC-UK-USB-CBM
		Copper	EK-PSC-UK-USB-COP
		Champagne	EK-PSC-UK-USB-CHA

FENIX NTM®-EFFECT PAINTING

Version	Dimensions	Colour	Code		
Italian	55 x 55 mm	malè white	EK-PSC-IT-USB-FBM		
		beige luxor	EK-PSC-IT-USB-FBL		
		beaver ottawa	EK-PSC-IT-USB-FCO		
		cocoa orinoco	EK-PSC-IT-USB-FCC		
		grey efeso	EK-PSC-IT-USB-FGE		
		grey london	EK-PSC-IT-USB-FGL		
		grey bromine	EK-PSC-IT-USB-FGB		
		green commodore	EK-PSC-IT-USB-FVC		
		black ingo	EK-PSC-IT-USB-FNI		
		UK	55 x 55 mm	malè white	EK-PSC-UK-USB-FBM
				beige luxor	EK-PSC-UK-USB-FBL
beaver ottawa	EK-PSC-UK-USB-FCO				
cocoa orinoco	EK-PSC-UK-USB-FCC				
grey efeso	EK-PSC-UK-USB-FGE				
grey london	EK-PSC-UK-USB-FGL				
grey bromine	EK-PSC-UK-USB-FGB				
green commodore	EK-PSC-UK-USB-FVC				
black ingo	EK-PSC-UK-USB-FNI				

Power socket USB A/C

The ordering code for the coloured cover of an electrical socket is formed by a fixed part (EK-PSC) and a variable part depending on the version (Italian or Schuko) and the colour. The ordering code for the power socket USB body only is EK-PWS-.-USB (IT - DE - FR - UK).

PLASTIC MATERIAL

Version	Dimensions	Colour	Finishing	Code
Schuko	55 x 55 mm	white	normal	EK-PSC-DE-USB-GAA
		Intense black RAL 9005		EK-PSC-DE-USB-GAE
		silver		EK-PSC-DE-USB-GAG
French	55 x 55 mm	white		EK-PSC-FR-USB-GAA
		Intense black RAL 9005		EK-PSC-FR-USB-GAE
		silver		EK-PSC-FR-USB-GAG

METAL-EFFECT PAINTING

Version	Dimensions	Colour	Code
Schuko	55 x 55 mm	aluminium	EK-PSC-DE-USB-GBQ
		nickel	EK-PSC-DE-USB-GBR
		titanium	EK-PSC-DE-USB-GBS
		carbon	EK-PSC-DE-USB-GBU
		brass	EK-PSC-DE-USB-GBB
French	55 x 55 mm	aluminium	EK-PSC-FR-USB-GBQ
		nickel	EK-PSC-FR-USB-GBR
		titanium	EK-PSC-FR-USB-GBS
		carbon	EK-PSC-FR-USB-GBU
		brass	EK-PSC-FR-USB-GBB

METAL HT

Version	Dimensions	Colour	Code
Schuko	55 x 55 mm	Chrome	EK-PSC-DE-USB-CRO
		Black Metal	EK-PSC-DE-USB-CBM
		Copper	EK-PSC-DE-USB-COP
		Champagne	EK-PSC-DE-USB-CHA
French	55 x 55 mm	Chrome	EK-PSC-FR-USB-CRO
		Black Metal	EK-PSC-FR-USB-CBM
		Copper	EK-PSC-FR-USB-COP
		Champagne	EK-PSC-FR-USB-CHA

FENIX NTM®-EFFECT PAINTING

Version	Dimensions	Colour	Code		
Schuko	55 x 55 mm	malè white	EK-PSC-DE-USB-FBM		
		beige luxor	EK-PSC-DE-USB-FBL		
		beaver ottawa	EK-PSC-DE-USB-FCO		
		cocoa orinoco	EK-PSC-DE-USB-FCC		
		grey efeso	EK-PSC-DE-USB-FGE		
		grey london	EK-PSC-DE-USB-FGL		
		grey bromine	EK-PSC-DE-USB-FGB		
		green commodore	EK-PSC-DE-USB-FVC		
		black ingo	EK-PSC-DE-USB-FNI		
		French	55 x 55 mm	malè white	EK-PSC-FR-USB-FBM
				beige luxor	EK-PSC-FR-USB-FBL
beaver ottawa	EK-PSC-FR-USB-FCO				
cocoa orinoco	EK-PSC-FR-USB-FCC				
grey efeso	EK-PSC-FR-USB-FGE				
grey london	EK-PSC-FR-USB-FGL				
grey bromine	EK-PSC-FR-USB-FGB				
green commodore	EK-PSC-FR-USB-FVC				
black ingo	EK-PSC-FR-USB-FNI				



How to order a frame

WALL-MOUNT DEVICES



Form and Flank frames for devices of FF and 71 series.

The ordering number of a frame includes a fixed part (EK-) and a variable part which depends on the series (Form or Flank), shape (square, rectangular or double), material, colour and finishing.

PLASTIC MATERIAL

Series	Modularity	Colour	Finishing	Code
FF - 71	 square	white	normal	EK-FOQ-GAA
		intense black RAL 9005		EK-FOQ-GAE
		silver		EK-FOQ-GAG
	 rectangular	white		EK-FOR-GAA
		intense black RAL 9005		EK-FOR-GAE
		silver		EK-FOR-GAG
	 double	white		EK-FO2-GAA
		intense black RAL 9005		EK-FO2-GAB
		silver		EK-FO2-GAD

METAL

Series	Modularity	Colour	Finishing	Code
FF - 71	 square	aluminium	brushed	EK-FOQ-GBQ
		nickel		EK-FOQ-GBR
		titanium		EK-FOQ-GBS
		carbon		EK-FOQ-GBU
		brass		EK-FOQ-GBB
	 rectangular	aluminium		EK-FOR-GBQ
		nickel		EK-FOR-GBR
		titanium		EK-FOR-GBS
		carbon		EK-FOR-GBU
		brass		EK-FOR-GBB
	 double	aluminium		EK-FO2-GBQ
		nickel		EK-FO2-GBR
		titanium		EK-FO2-GBS
		carbon		EK-FO2-GBU
		brass		EK-FO2-GBB



Frame Form version

WALL-MOUNT DEVICES

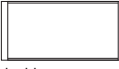
PLASTIC MATERIAL

Series	Modularity	Colour	Finishing	Code
FF - 71	 square	white	normal	EK-FLQ-GAA
		intense black RAL 9005		EK-FLQ-GAE
		silver		EK-FLQ-GAG
	 double	white		EK-FL2-GAA
		intense black RAL 9005		EK-FL2-GAE
		silver		EK-FL2-GAG

METAL

Series	Modularity	Colour	Finishing	Code
FF - 71	 square	aluminium	brushed	EK-FLQ-GBQ
		nickel		EK-FLQ-GBR
		titanium		EK-FLQ-GBS
		carbon		EK-FLQ-GBU
		brass		EK-FLQ-GBB
	 rectangular	aluminium		EK-FLR-GBQ
		nickel		EK-FLR-GBR
		titanium		EK-FLR-GBS
		carbon		EK-FLR-GBU
		brass		EK-FLR-GBB
	 double	aluminium		EK-FL2-GBQ
		nickel		EK-FL2-GBR
		titanium		EK-FL2-GBS
		carbon		EK-FL2-GBU
		brass		EK-FL2-GBB

Frame Flank version

WALL-MOUNT DEVICES

How to order a plate

WALL-MOUNT DEVICES

Plates for devices of 71 series and flush-mounting inserts.

The ordering code of a plate consists of a fixed part (EK-P) and a variable part depending on shape (square or rectangular), window size (small or large), material, colour and finishing.

FENIX NTM®

Series	Window	Colour	Code	
FF - 71	45 x 45 mm	malè white	EK-PQP-FBM	
		beige luxor	EK-PQP-FBL	
		beaver ottawa	EK-PQP-FCO	
		cocoa orinoco	EK-PQP-FCC	
		grey efeso	EK-PQP-FGE	
		grey london	EK-PQP-FGL	
	55 x 55 mm	grey bromine	EK-PQP-FGB	
		green commodore	EK-PQP-FVC	
		black ingo	EK-PQP-FNI	
		malè white	EK-PQG-FBM	
		beige luxor	EK-PQG-FBL	
		beaver ottawa	EK-PQG-FCO	
60 x 60 mm	cocoa orinoco	grey efeso	EK-PQG-FCC	
		grey london	EK-PQG-FGL	
		grey bromine	EK-PQG-FGB	
		green commodore	EK-PQG-FVC	
		black ingo	EK-PQG-FNI	
		malè white	EK-PQS-FBM	
	Movement sensor	50 x 50 mm	beige luxor	EK-PQS-FBL
			beaver ottawa	EK-PQS-FCO
			cocoa orinoco	EK-PQS-FCC
			grey efeso	EK-PQS-FGE
			grey london	EK-PQS-FGL
			grey bromine	EK-PQS-FGB
Movement sensor	50 x 50 mm	green commodore	EK-PQS-FVC	
		black ingo	EK-PQS-FNI	
		malè white	EK-PQN-FBM	
		beige luxor	EK-PQN-FBL	
		beaver ottawa	EK-PQN-FCO	
		cocoa orinoco	EK-PQN-FCC	
	50 x 50 mm	grey efeso	EK-PQN-FGE	
		grey london	EK-PQN-FGL	
		grey bromine	EK-PQN-FGB	
		green commodore	EK-PQN-FVC	
		black ingo	EK-PQN-FNI	

Square plate

WALL-MOUNT DEVICES

METAL

Series	Window	Colour	Finishing	Code
FF - 71	45 x 45 mm	aluminium	brushed	EK-PQP-GBQ
		nickel		EK-PQP-GBR
		titanium		EK-PQP-GBS
		carbon		EK-PQP-GBU
		brass		EK-PQP-GBB
		aluminium		EK-PQG-GBQ
	55 x 55 mm	nickel	EK-PQG-GBR	
		titanium	EK-PQG-GBS	
		carbon	EK-PQG-GBU	
		brass	EK-PQG-GBB	
		aluminium	EK-PQS-GBQ	
		nickel	EK-PQS-GBR	
	60 x 60 mm	titanium	EK-PQS-GBS	
		carbon	EK-PQS-GBU	
		brass	EK-PQS-GBB	
		aluminium	EK-PQN-GBQ	
		nickel	EK-PQN-GBR	
		titanium	EK-PQN-GBS	
Movement sensor	50 x 50 mm	carbon	EK-PQN-GBU	
		brass	EK-PQN-GBB	

PLASTIC MATERIAL

Series	Window	Colour	Finishing	Code
FF - 71	45 x 45 mm	white	normal	EK-PQP-GAA
		intense black RAL 9005		EK-PQP-GAE
		silver		EK-PQP-GAG
	55 x 55 mm	white	EK-PQG-GAA	
		intense black RAL 9005	EK-PQG-GAE	
		silver	EK-PQG-GAG	
	60 x 60 mm	white	EK-PQS-GAA	
		intense black RAL 9005	EK-PQS-GAE	
		silver	EK-PQS-GAG	
	Movement sensor	50 x 50 mm	white	EK-PQN-GAA
			intense black RAL 9005	EK-PQN-GAE
			silver	EK-PQN-GAG

PLASTIC MATERIAL

Series	Window	Colour	Finishing	Code
FF - 71	68 x 45 mm	white	normal	EK-PRG-GAA
		intense black RAL 9005		EK-PRG-GAE
		silver		EK-PRG-GAG
	60 x 60 mm	white		EK-PRS-GAA
		intense black RAL 9005		EK-PRS-GAE
		silver		EK-PRS-GAG

FENIX NTM®

Series	Window	Colour	Code
FF - 71	68 x 45 mm	malè white	EK-PRG-FBM
		beige luxor	EK-PRG-FBL
		beaver ottawa	EK-PRG-FCO
		cocoa orinoco	EK-PRG-FCC
		grey efeso	EK-PRG-FGE
		grey london	EK-PRG-FGL
	60 x 60 mm	grey bromine	EK-PRG-FGB
		green commodore	EK-PRG-FVC
		black ingo	EK-PRG-FNI
		malè white	EK-PRS-FBM
		beige luxor	EK-PRS-FBL
		beaver ottawa	EK-PRS-FCO
60 x 60 mm	cocoa orinoco	EK-PRS-FCC	
	grey efeso	EK-PRS-FGE	
	grey london	EK-PRS-FGL	
	grey bromine	EK-PRS-FGB	
	green commodore	EK-PRS-FVC	
	black ingo	EK-PRS-FNI	

Rectangular plate

WALL-MOUNT DEVICES

METAL

Series	Window	Colour	Finishing	Code
FF - 71	68 x 45 mm	aluminium	brushed	EK-PRG-GBQ
		nickel		EK-PRG-GBR
		titanium		EK-PRG-GBS
		carbon		EK-PRG-GBU
		brass		EK-PRG-GBB
		aluminium		EK-PRS-GBQ
	60 x 60 mm	nickel	EK-PRS-GBR	
		titanium	EK-PRS-GBS	
		carbon	EK-PRS-GBU	
		brass	EK-PRS-GBB	

Double plate

WALL-MOUNT DEVICES

PLASTIC MATERIAL

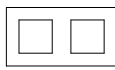
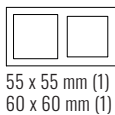
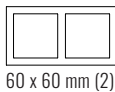
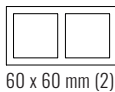
Series	Window	Colour	Finishing	Code
FF - 71	 55 x 55 mm (2)	white	normal	EK-P2P-GAA
		intense black RAL 9005		EK-P2P-GAE
		silver		EK-P2P-GAG
	 55 x 55 mm (1) 60 x 60 mm (1)	white		EK-P2G-GAA
		intense black RAL 9005		EK-P2G-GAE
		silver		EK-P2G-GAG
	 60 x 60 mm (2)	white		EK-P2S-GAA
		intense black RAL 9005		EK-P2S-GAE
		silver		EK-P2S-GAG
	 60 x 60 mm (2) swiss market	white		EK-P2H-GAA
		intense black RAL 9005		EK-P2H-GAE
		silver		EK-P2H-GAG

METAL

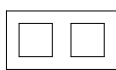
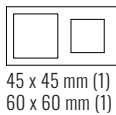
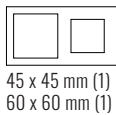
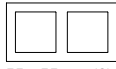
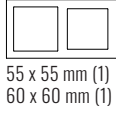
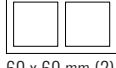
Series	Window	Colour	Finishing	Code	
FF - 71	 45 x 45 mm (2)	aluminium	brushed	EK-P2E-GBQ	
		nickel		EK-P2E-GBR	
		titanium		EK-P2E-GBS	
		 45 x 45 mm (1) 60 x 60 mm (1)		carbon	EK-P2E-GBU
				brass	EK-P2E-GBB
				aluminium	EK-P2F-GBQ
	 45 x 45 mm (1) 60 x 60 mm (1)	nickel		EK-P2F-GBR	
		titanium		EK-P2F-GBS	
		carbon		EK-P2F-GBU	
		brass		EK-P2F-GBB	
		aluminium		EK-P2P-GBQ	
		nickel		EK-P2P-GBR	
	 55 x 55 mm (2)	titanium		EK-P2P-GBS	
		carbon		EK-P2P-GBU	
		brass		EK-P2P-GBB	
		aluminium		EK-P2G-GBQ	
		nickel		EK-P2G-GBR	
		titanium		EK-P2G-GBS	
	 55 x 55 mm (1) 60 x 60 mm (1)	carbon		EK-P2G-GBU	
		brass		EK-P2G-GBB	
		aluminium		EK-P2S-GBQ	
		nickel		EK-P2S-GBR	
		titanium		EK-P2S-GBS	
		carbon		EK-P2S-GBU	
	 60 x 60 mm (2)	brass		EK-P2S-GBB	
		aluminium		EK-P2H-GBQ	
		nickel		EK-P2H-GBR	
		titanium		EK-P2H-GBS	
		carbon		EK-P2H-GBU	
		brass		EK-P2H-GBB	

Double plate

WALL-MOUNT DEVICES

FENIX NTM®

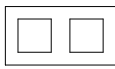
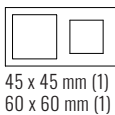
Series	Window	Colour	Code
FF - 71	 45 x 45 mm (2)	malè white	EK-P2E-FBM
		beige luxor	EK-P2E-FBL
		beaver ottawa	EK-P2E-FCO
		cocoa orinoco	EK-P2E-FCC
		grey efeso	EK-P2E-FGE
		grey london	EK-P2E-FGL
		grey bromine	EK-P2E-FGB
		green commodore	EK-P2E-FVC
		black ingo	EK-P2E-FNI
		malè white	EK-P2F-FBM
		beige luxor	EK-P2F-FBL
		beaver ottawa	EK-P2F-FCO
	 45 x 45 mm (1) 60 x 60 mm (1)	cocoa orinoco	EK-P2F-FCC
		grey efeso	EK-P2F-FGE
		grey london	EK-P2F-FGL
		grey bromine	EK-P2F-FGB
		green commodore	EK-P2F-FVC
		black ingo	EK-P2F-FNI
		malè white	EK-P2P-FBM
		beige luxor	EK-P2P-FBL
		beaver ottawa	EK-P2P-FCO
		cocoa orinoco	EK-P2P-FCC
		grey efeso	EK-P2P-FGE
		grey london	EK-P2P-FGL
grey bromine	EK-P2P-FGB		
green commodore	EK-P2P-FVC		
black ingo	EK-P2P-FNI		

FENIX NTM®

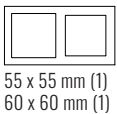
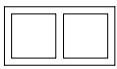
Series	Window	Colour	Code
FF - 71	 55 x 55 mm (1) 60 x 60 mm (1)	malè white	EK-P2G-FBM
		beige luxor	EK-P2G-FBL
		beaver ottawa	EK-P2G-FCO
		cocoa orinoco	EK-P2G-FCC
		grey efeso	EK-P2G-FGE
		grey london	EK-P2G-FGL
		grey bromine	EK-P2G-FGB
		green commodore	EK-P2G-FVC
		black ingo	EK-P2G-FNI
		malè white	EK-P2S-FBM
		beige luxor	EK-P2S-FBL
		beaver ottawa	EK-P2S-FCO
	 60 x 60 mm (2)	cocoa orinoco	EK-P2S-FCC
		grey efeso	EK-P2S-FGE
		grey london	EK-P2S-FGL
		grey bromine	EK-P2S-FGB
		green commodore	EK-P2S-FVC
		black ingo	EK-P2S-FNI
		malè white	EK-P2H-FBM
		beige luxor	EK-P2H-FBL
		beaver ottawa	EK-P2H-FCO
		cocoa orinoco	EK-P2H-FCC
		grey efeso	EK-P2H-FGE
		grey london	EK-P2H-FGL
grey bromine	EK-P2H-FGB		
green commodore	EK-P2H-FVC		
black ingo	EK-P2H-FNI		

How to order a Deep plate





WALL-MOUNT DEVICES

Deep plates for devices of Signum, 20venti and 71 series. The ordering code of a Deep plate consists of a fixed part (EK-D) and a variable part depending on shape (square or rectangular), window size (small or large), material, colour and finishing.







Deep square plate

WALL-MOUNT DEVICES





PLASTIC MATERIAL

Series	Window	Colour	Finishing	Code
20venti (4 rockers)	 30 x 60 mm	white	normal	EK-DQT-GAA
		intense black RAL 9005		EK-DQT-GAE
		silver		EK-DQT-GAG
20venti FF 71	 45 x 45 mm	white	EK-DQP-GAA	
		intense black RAL 9005	EK-DQP-GAE	
		silver	EK-DQP-GAG	
20venti FF 71	 55 x 55 mm	white	EK-DQG-GAA	
		intense black RAL 9005	EK-DQG-GAE	
		silver	EK-DQG-GAG	
Movement sensor	 60 x 60 mm	white	EK-DQS-GAA	
		intense black RAL 9005	EK-DQS-GAE	
		silver	EK-DQS-GAG	
Movement sensor	 50 x 50 mm	white	EK-DQN-GAA	
		intense black RAL 9005	EK-DQN-GAE	
		silver	EK-DQN-GAG	

METAL

Series	Window	Colour	Finishing	Code	
Signum	 30 x 60 mm	aluminium	normal	EK-DQZ-GBQ	
		nickel		EK-DQZ-GBR	
		titanium		EK-DQZ-GBS	
		carbon		EK-DQZ-GBU	
		brass		EK-DQZ-GBB	
20venti (4 rockers)	 30 x 60 mm	aluminium	normal	EK-DQT-GBQ	
		nickel		EK-DQT-GBR	
		titanium		EK-DQT-GBS	
		carbon		EK-DQT-GBU	
		brass		EK-DQT-GBB	
20venti FF 71	 45 x 45 mm	aluminium	brushed	EK-DQP-GBQ	
		nickel		EK-DQP-GBR	
		titanium		EK-DQP-GBS	
		carbon		EK-DQP-GBU	
		brass		EK-DQP-GBB	
	20venti FF 71	 55 x 55 mm		aluminium	EK-DQG-GBQ
				nickel	EK-DQG-GBR
				titanium	EK-DQG-GBS
				carbon	EK-DQG-GBU
				brass	EK-DQG-GBB
Movement sensor	 60 x 60 mm	aluminium	brushed	EK-DQS-GBQ	
		nickel		EK-DQS-GBR	
		titanium		EK-DQS-GBS	
		carbon		EK-DQS-GBU	
		brass		EK-DQS-GBB	
	Movement sensor	 50 x 50 mm		aluminium	EK-DQN-GBQ
				nickel	EK-DQN-GBR
				titanium	EK-DQN-GBS
				carbon	EK-DQN-GBU
				brass	EK-DQN-GBB







METAL HT

Series	Window	Colour	Finishing	Code
Signum	 30 x 60 mm	Chrome	normal	EK-DQZ-CRO
		Black Metal		EK-DQZ-CBM
		Copper		EK-DQZ-COP
		Champagne		EK-DQZ-CHA
20venti (4 rockers)	 30 x 60 mm	Chrome	normal	EK-DQT-CRO
		Black Metal		EK-DQT-CBM
		Copper		EK-DQT-COP
		Champagne		EK-DQT-CHA
20venti FF 71	 45 x 45 mm	Chrome	chrome plated	EK-DQP-CRO
		Black Metal		EK-DQP-CBM
		Copper		EK-DQP-COP
		Champagne		EK-DQP-CHA
20venti FF 71	 55 x 55 mm	Chrome	normal	EK-DQG-CRO
		Black Metal		EK-DQG-CBM
		Copper		EK-DQG-COP
		Champagne		EK-DQG-CHA
20venti FF 71	 60 x 60 mm	Chrome	normal	EK-DQS-CRO
		Black Metal		EK-DQS-CBM
		Copper		EK-DQS-COP
		Champagne		EK-DQS-CHA

Deep square plate

WALL-MOUNT DEVICES

FENIX NTM®

Series	Window	Colour	Code
Signum	 30 x 60 mm	malè white	EK-DQZ-FBM
		beige luxor	EK-DQZ-FBL
		beaver ottawa	EK-DQZ-FCO
		cocoa orinoco	EK-DQZ-FCC
		grey efeso	EK-DQZ-FGE
		grey london	EK-DQZ-FGL
		grey bromine	EK-DQZ-FGB
		green commodore	EK-DQZ-FVC
		black ingo	EK-DQZ-FNI
		20venti (4 rockers)	 30 x 60 mm
beige luxor	EK-DQT-FBL		
beaver ottawa	EK-DQT-FCO		
cocoa orinoco	EK-DQT-FCC		
grey efeso	EK-DQT-FGE		
grey london	EK-DQT-FGL		
grey bromine	EK-DQT-FGB		
green commodore	EK-DQT-FVC		
black ingo	EK-DQT-FNI		
20venti FF 71	 45 x 45 mm		
		beige luxor	EK-DQP-FBL
		beaver ottawa	EK-DQP-FCO
		cocoa orinoco	EK-DQP-FCC
		grey efeso	EK-DQP-FGE
		grey london	EK-DQP-FGL
		grey bromine	EK-DQP-FGB
		green commodore	EK-DQP-FVC
		black ingo	EK-DQP-FNI
		20venti FF 71	 55 x 55 mm
beige luxor	EK-DQG-FBL		
beaver ottawa	EK-DQG-FCO		
cocoa orinoco	EK-DQG-FCC		
grey efeso	EK-DQG-FGE		
grey london	EK-DQG-FGL		
grey bromine	EK-DQG-FGB		
green commodore	EK-DQG-FVC		
black ingo	EK-DQG-FNI		
Movement sensor	 60 x 60 mm		
		beige luxor	EK-DQS-FBL
		beaver ottawa	EK-DQS-FCO
		cocoa orinoco	EK-DQS-FCC
		grey efeso	EK-DQS-FGE
		grey london	EK-DQS-FGL
		grey bromine	EK-DQS-FGB
		green commodore	EK-DQS-FVC
		black ingo	EK-DQS-FNI
		Movement sensor	 50 x 50 mm
beige luxor	EK-DQN-FBL		
beaver ottawa	EK-DQN-FCO		
cocoa orinoco	EK-DQN-FCC		
grey efeso	EK-DQN-FGE		
grey london	EK-DQN-FGL		
grey bromine	EK-DQN-FGB		
green commodore	EK-DQN-FVC		
black ingo	EK-DQN-FNI		

Deep rectangular plate

WALL-MOUNT DEVICES

PLASTIC MATERIAL

Series	Window	Colour	Finishing	Code
20venti FF 71	68 x 45 mm	white	normal	EK-DRG-GAA
		intense black RAL 9005		EK-DRG-GAE
		silver		EK-DRG-GAG
	60 x 60 mm	white		EK-DRS-GAA
		intense black RAL 9005		EK-DRS-GAE
		silver		EK-DRS-GAG

FENIX NTM®

Series	Window	Colour	Code
20venti FF 71	68 x 45 mm	malè white	EK-DRG-FBM
		beige luxor	EK-DRG-FBL
		beaver ottawa	EK-DRG-FCO
		cocoa orinoco	EK-DRG-FCC
		grey efeso	EK-DRG-FGE
		grey london	EK-DRG-FGL
		grey bromine	EK-DRG-FGB
		green commodore	EK-DRG-FVC
		black ingo	EK-DRG-FNI
		malè white	EK-DRS-FBM
		beige luxor	EK-DRS-FBL
		beaver ottawa	EK-DRS-FCO
	60 x 60 mm	cocoa orinoco	EK-DRS-FCC
		grey efeso	EK-DRS-FGE
		grey london	EK-DRS-FGL
		grey bromine	EK-DRS-FGB
		green commodore	EK-DRS-FVC
		black ingo	EK-DRS-FNI

METAL

Series	Window	Colour	Finishing	Code
20venti FF 71	68 x 45 mm	aluminium	brushed	EK-DRG-GBQ
		nickel		EK-DRG-GBR
		titanium		EK-DRG-GBS
		carbon		EK-DRG-GBU
		brass		EK-DRG-GBB
		aluminium		EK-DRS-GBQ
	60 x 60 mm	nickel		EK-DRS-GBR
		titanium		EK-DRS-GBS
		carbon		EK-DRS-GBU
		brass		EK-DRS-GBB

METAL HT

Series	Window	Colour	Finishing	Code
20venti FF 71	68 x 45 mm	Chrome	chrome plated	EK-DRG-CRO
		Black Metal		EK-DRG-CBM
		Copper		EK-DRG-COP
		Champagne		EK-DRG-CHA
		Chrome		EK-DRS-CRO
		Black Metal		EK-DRS-CBM
	60 x 60 mm	Copper		EK-DRS-COP
		Champagne		EK-DRS-CHA

Deep double plate

WALL-MOUNT DEVICES

PLASTIC MATERIAL

Series	Window	Colour	Finishing	Code
20venti FF 71	55 x 55 mm (2)	white	normal	EK-D2P-GAA
		intense black RAL 9005		EK-D2P-GAE
		silver		EK-D2P-GAG
	45 x 45 mm (1) 60 x 60 mm (1)	white		EK-D2F-GAA
		intense black RAL 9005		EK-D2F-GAE
		silver		EK-D2F-GAG
	55 x 55 mm (1) 60 x 60 mm (1)	white		EK-D2G-GAA
		intense black RAL 9005		EK-D2G-GAE
		silver		EK-D2G-GAG
	60 x 60 mm (2)	white		EK-D2S-GAA
		intense black RAL 9005		EK-D2S-GAE
		silver		EK-D2S-GAG
	60 x 60 mm (2) swiss market	white		EK-D2H-GAA
		intense black RAL 9005		EK-D2H-GAE
		silver		EK-D2H-GAG





METAL

Series	Window	Colour	Finishing	Code
FF - 71	45 x 45 mm (2)	aluminium	brushed	EK-D2E-GBQ
		nickel		EK-D2E-GBR
		titanium		EK-D2E-GBS
		carbon		EK-D2E-GBU
		brass		EK-D2E-GBB
		aluminium		EK-D2F-GBQ
	45 x 45 mm (1) 60 x 60 mm (1)	nickel		EK-D2F-GBR
		titanium		EK-D2F-GBS
		carbon		EK-D2F-GBU
		brass		EK-D2F-GBB
		aluminium		EK-D2P-GBQ
		55 x 55 mm (2)		nickel
	titanium			EK-D2P-GBS
	carbon			EK-D2P-GBU
	brass			EK-D2P-GBB
	aluminium			EK-D2G-GBQ
	55 x 55 mm (1) 60 x 60 mm (1)			nickel
		titanium		EK-D2G-GBS
		carbon		EK-D2G-GBU
		brass		EK-D2G-GBB
		aluminium		EK-D2S-GBQ
		60 x 60 mm (2)		nickel
	titanium			EK-D2S-GBS
	carbon			EK-D2S-GBU
brass	EK-D2S-GBB			
aluminium	EK-D2H-GBQ			
60 x 60 mm (2) swiss market	nickel		EK-D2H-GBR	
	titanium	EK-D2H-GBS		
	carbon	EK-D2H-GBU		
	brass	EK-D2H-GBB		

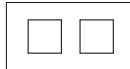
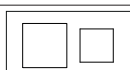

Deep double plate

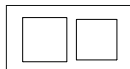
WALL-MOUNT DEVICES

METAL HT

Series	Window	Colour	Finishing	Code
20venti FF 71		Chrome	chrome plated	EK-D2E-CRO
		Black Metal		EK-D2E-CBM
	Copper	EK-D2E-COP		
	Champagne	EK-D2E-CHA		
		Chrome		EK-D2F-CRO
		Black Metal		EK-D2F-CBM
	Copper	EK-D2F-COP		
	Champagne	EK-D2F-CHA		
		Chrome		EK-D2P-CRO
		Black Metal		EK-D2P-CBM
	Copper	EK-D2P-COP		
	Champagne	EK-D2P-CHA		
		Chrome		EK-D2G-CRO
		Black Metal		EK-D2G-CBM
Copper	EK-D2G-COP			
Champagne	EK-D2G-CHA			
	Chrome	EK-D2S-CRO		
	Black Metal	EK-D2S-CBM		
Copper	EK-D2S-COP			
Champagne	EK-D2S-CHA			
	Chrome	EK-D2H-CRO		
	Black Metal	EK-D2H-CBM		
Copper	EK-D2H-COP			
Champagne	EK-D2H-CHA			

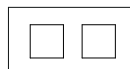
FENIX NTM®

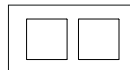
Series	Window	Colour	Code
20venti FF 71		malè white	EK-D2E-FBM
		beige luxor	EK-D2E-FBL
	beaver ottawa	EK-D2E-FCO	
	cocoa orinoco	EK-D2E-FCC	
	grey efeso	EK-D2E-FGE	
	grey london	EK-D2E-FGL	
	grey bromine	EK-D2E-FGB	
	green commodore	EK-D2E-FVC	
	black ingo	EK-D2E-FNI	
	malè white	EK-D2F-FBM	
	beige luxor	EK-D2F-FBL	
	beaver ottawa	EK-D2F-FCO	
	cocoa orinoco	EK-D2F-FCC	
	grey efeso	EK-D2F-FGE	
grey london	EK-D2F-FGL		
grey bromine	EK-D2F-FGB		
green commodore	EK-D2F-FVC		
black ingo	EK-D2F-FNI		
20venti FF 71		malè white	EK-D2P-FBM
		beige luxor	EK-D2P-FBL
	beaver ottawa	EK-D2P-FCO	
	cocoa orinoco	EK-D2P-FCC	
	grey efeso	EK-D2P-FGE	
	grey london	EK-D2P-FGL	
	grey bromine	EK-D2P-FGB	
	green commodore	EK-D2P-FVC	
	black ingo	EK-D2P-FNI	
	malè white	EK-D2G-FBM	
	beige luxor	EK-D2G-FBL	
	beaver ottawa	EK-D2G-FCO	
	cocoa orinoco	EK-D2G-FCC	
	grey efeso	EK-D2G-FGE	
grey london	EK-D2G-FGL		
grey bromine	EK-D2G-FGB		
green commodore	EK-D2G-FVC		
black ingo	EK-D2G-FNI		
20venti FF 71		malè white	EK-D2S-FBM
		beige luxor	EK-D2S-FBL
	beaver ottawa	EK-D2S-FCO	
	cocoa orinoco	EK-D2S-FCC	
	grey efeso	EK-D2S-FGE	
	grey london	EK-D2S-FGL	
	grey bromine	EK-D2S-FGB	
	green commodore	EK-D2S-FVC	
	black ingo	EK-D2S-FNI	
	malè white	EK-D2H-FBM	
	beige luxor	EK-D2H-FBL	
	beaver ottawa	EK-D2H-FCO	
	cocoa orinoco	EK-D2H-FCC	
	grey efeso	EK-D2H-FGE	
grey london	EK-D2H-FGL		
grey bromine	EK-D2H-FGB		
green commodore	EK-D2H-FVC		
black ingo	EK-D2H-FNI		

ALUMINIUM

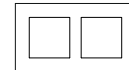
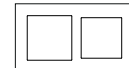
Series	Window	Colour	Finishing	Code
20venti FF 71		aluminium	brushed	EK-D3P-GBQ
		nickel		EK-D3P-GBR
	titanium	EK-D3P-GBS		
	carbon	EK-D3P-GBU		
		brass		EK-D3P-GBB
		aluminium		EK-D3G-GBQ
	nickel	EK-D3G-GBR		
	titanium	EK-D3G-GBS		
	carbon	EK-D3G-GBU		
	brass	EK-D3G-GBB		

METAL HT

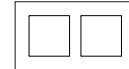
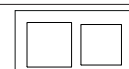
Series	Window	Colour	Finishing	Code
20venti FF 71		Chrome	chrome plated	EK-D3P-CRO
		Black Metal		EK-D3P-CBM
	Copper	EK-D3P-COP		
	Champagne	EK-D3P-CHA		
		Chrome		EK-D3G-CRO
		Black Metal		EK-D3G-CBM
	Copper	EK-D3G-COP		
	Champagne	EK-D3G-CHA		

Deep triple plate

WALL-MOUNT DEVICES

FENIX NTM®

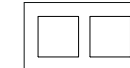
Series	Window	Colour	Code
20venti FF 71		malè white	EK-D3P-FBM
		beige luxor	EK-D3P-FBL
	beaver ottawa	EK-D3P-FCO	
	cocoa orinoco	EK-D3P-FCC	
	grey efeso	EK-D3P-FGE	
	grey london	EK-D3P-FGL	
	grey bromine	EK-D3P-FGB	
	green commodore	EK-D3P-FVC	
	black ingo	EK-D3P-FNI	
	malè white	EK-D3G-FBM	
	beige luxor	EK-D3G-FBL	
	beaver ottawa	EK-D3G-FCO	
	cocoa orinoco	EK-D3G-FCC	
	grey efeso	EK-D3G-FGE	
grey london	EK-D3G-FGL		
grey bromine	EK-D3G-FGB		
green commodore	EK-D3G-FVC		
black ingo	EK-D3G-FNI		

How to order a Surface plate







WALL-MOUNT DEVICES

Surface plates for devices of 20venti, 71 series and flush-mounting inserts. The ordering code of a Surface plate consists of a fixed part (EK-S) and a variable part depending on shape (square or rectangular), window size (small or large), material, colour and finishing.





Surface square plate

WALL-MOUNT DEVICES

METAL

Series	Window	Colour	Finishing	Code
Signum		aluminium		EK-SQZ-GBQ
		nickel		EK-SQZ-GBR
		titanium		EK-SQZ-GBS
		carbon		EK-SQZ-GBU
		brass		EK-SQZ-GBB
20venti (4 rockers)		aluminium		EK-SQT-GBQ
		nickel		EK-SQT-GBR
		titanium		EK-SQT-GBS
		carbon		EK-SQT-GBU
		brass		EK-SQT-GBB
		aluminium	brushed	EK-SQP-GBQ
		nickel		EK-SQP-GBR
		titanium		EK-SQP-GBS
		carbon		EK-SQP-GBU
		brass		EK-SQP-GBB
20venti FF 71		aluminium		EK-SQG-GBQ
		nickel		EK-SQG-GBR
		titanium		EK-SQG-GBS
		carbon		EK-SQG-GBU
		brass		EK-SQG-GBB
		aluminium		EK-SQS-GBQ
		nickel		EK-SQS-GBR
		titanium		EK-SQS-GBS
		carbon		EK-SQS-GBU
		brass		EK-SQS-GBB
Movement sensor		aluminium		EK-SQN-GBQ
		nickel		EK-SQN-GBR
		titanium		EK-SQN-GBS
		carbon		EK-SQN-GBU
		brass		EK-SQN-GBB

METAL HT

Series	Window	Colour	Finishing	Code
Signum		Chrome		EK-SQZ-CRO
		Black Metal		EK-SQZ-CBM
		Copper		EK-SQZ-COP
		Champagne		EK-SQZ-CHA
20venti (4 rockers)		Chrome		EK-SQT-CRO
		Black Metal		EK-SQT-CBM
		Copper		EK-SQT-COP
		Champagne		EK-SQT-CHA
		Chrome	chrome plated	EK-SQP-CRO
		Black Metal		EK-SQP-CBM
		Copper		EK-SQP-COP
		Champagne		EK-SQP-CHA
20venti FF 71		Chrome		EK-SQG-CRO
		Black Metal		EK-SQG-CBM
		Copper		EK-SQG-COP
		Champagne		EK-SQG-CHA
		Chrome		EK-SQS-CRO
		Black Metal		EK-SQS-CBM
		Copper		EK-SQS-COP
		Champagne		EK-SQS-CHA



Surface square plate

WALL-MOUNT DEVICES

FENIX NTM®

Series	Window	Colour	Code
Signum		malè white	EK-SQZ-FBM
		beige luxor	EK-SQZ-FBL
		beaver ottawa	EK-SQZ-FCO
		cocoa orinoco	EK-SQZ-FCC
		grey efeso	EK-SQZ-FGE
		grey london	EK-SQZ-FGL
		grey bromine	EK-SQZ-FGB
		green commodore	EK-SQZ-FVC
		black ingo	EK-SQZ-FNI
		malè white	EK-SQT-FBM
		beige luxor	EK-SQT-FBL
		beaver ottawa	EK-SQT-FCO
		cocoa orinoco	EK-SQT-FCC
		grey efeso	EK-SQT-FGE
grey london	EK-SQT-FGL		
grey bromine	EK-SQT-FGB		
green commodore	EK-SQT-FVC		
black ingo	EK-SQT-FNI		

20venti (4 rockers)
30 x 60 mm

Series	Window	Colour	Code
20venti FF 71		malè white	EK-SQP-FBM
		beige luxor	EK-SQP-FBL
		beaver ottawa	EK-SQP-FCO
		cocoa orinoco	EK-SQP-FCC
		grey efeso	EK-SQP-FGE
		grey london	EK-SQP-FGL
		grey bromine	EK-SQP-FGB
		green commodore	EK-SQP-FVC
		black ingo	EK-SQP-FNI
		malè white	EK-SQG-FBM
		beige luxor	EK-SQG-FBL
		beaver ottawa	EK-SQG-FCO
		cocoa orinoco	EK-SQG-FCC
		grey efeso	EK-SQG-FGE
grey london	EK-SQG-FGL		
grey bromine	EK-SQG-FGB		
green commodore	EK-SQG-FVC		
black ingo	EK-SQG-FNI		
Movement sensor		malè white	EK-SQN-FBM
		beige luxor	EK-SQN-FBL
		beaver ottawa	EK-SQN-FCO
		cocoa orinoco	EK-SQN-FCC
		grey efeso	EK-SQN-FGE
		grey london	EK-SQN-FGL
		grey bromine	EK-SQN-FGB
		green commodore	EK-SQN-FVC
		black ingo	EK-SQN-FNI
		malè white	EK-SQS-FBM
		beige luxor	EK-SQS-FBL
		beaver ottawa	EK-SQS-FCO
		cocoa orinoco	EK-SQS-FCC
		grey efeso	EK-SQS-FGE
grey london	EK-SQS-FGL		
grey bromine	EK-SQS-FGB		
green commodore	EK-SQS-FVC		
black ingo	EK-SQS-FNI		

55 x 55 mm



60 x 60 mm

50 x 50 mm

Surface double plate

WALL-MOUNT DEVICES

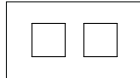
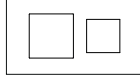
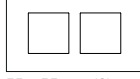
METAL

Series	Window	Colour	Finishing	Code
20venti FF 71		aluminium		EK-S2E-GBQ
		nickel		EK-S2E-GBR
		titanium		EK-S2E-GBS
		carbon		EK-S2E-GBU
		brass		EK-S2E-GBB
		aluminium		EK-S2F-GBQ
		nickel		EK-S2F-GBR
		titanium		EK-S2F-GBS
		carbon		EK-S2F-GBU
		brass		EK-S2F-GBB
		aluminium		EK-S2P-GBQ
			nickel	brushed
titanium	EK-S2P-GBS			
carbon	EK-S2P-GBU			
brass	EK-S2P-GBB			
aluminium	EK-S2G-GBQ			
	nickel		EK-S2G-GBR	
	titanium	EK-S2G-GBS		
	carbon	EK-S2G-GBU		
	brass	EK-S2G-GBB		
	aluminium	EK-S2S-GBQ		
		nickel	EK-S2S-GBR	
titanium		EK-S2S-GBS		
carbon		EK-S2S-GBU		
brass		EK-S2S-GBB		

METAL HT

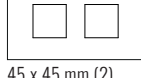
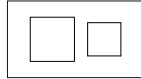
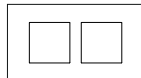
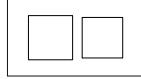
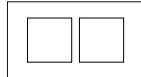
Series	Window	Colour	Finishing	Code
20venti FF 71		Chrome		EK-S2E-CRO
		Black Metal		EK-S2E-CBM
		Copper		EK-S2E-COP
		Champagne		EK-S2E-CHA
		Chrome		EK-S2F-CRO
		Black Metal		EK-S2F-CBM
		Copper		EK-S2F-COP
		Champagne		EK-S2F-GBB
		Chrome	chrome plated	EK-S2P-CRO
		Black Metal		EK-S2P-CBM
		Copper		EK-S2P-COP
		Champagne		EK-S2P-CHA
	Chrome	EK-S2G-CRO		
	Black Metal	EK-S2G-CBM		
	Copper	EK-S2G-COP		
	Champagne	EK-S2G-CHA		
	Chrome	EK-S2S-CRO		
	Black Metal	EK-S2S-CBM		
	Copper	EK-S2S-COP		
	Champagne	EK-S2S-GBB		

FENIX NTM®

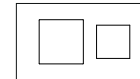
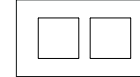
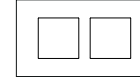
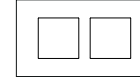
Series	Window	Colour	Code
20venti FF 71		malè white	EK-S2E-FBM
		beige luxor	EK-S2E-FBL
		beaver ottawa	EK-S2E-FCO
		cocoa orinoco	EK-S2E-FCC
		grey efeso	EK-S2E-FGE
		grey london	EK-S2E-FGL
		grey bromine	EK-S2E-FGB
		green commodore	EK-S2E-FVC
		black ingo	EK-S2E-FNI
		malè white	EK-S2F-FBM
		beige luxor	EK-S2F-FBL
		beaver ottawa	EK-S2F-FCO
	cocoa orinoco	EK-S2F-FCC	
	grey efeso	EK-S2F-FGE	
	grey london	EK-S2F-FGL	
	grey bromine	EK-S2F-FGB	
	green commodore	EK-S2F-FVC	
	black ingo	EK-S2F-FNI	
	malè white	EK-S2P-FBM	
	beige luxor	EK-S2P-FBL	
	beaver ottawa	EK-S2P-FCO	
	cocoa orinoco	EK-S2P-FCC	
	grey efeso	EK-S2P-FGE	
	grey london	EK-S2P-FGL	
	grey bromine	EK-S2P-FGB	
	green commodore	EK-S2P-FVC	
	black ingo	EK-S2P-FNI	

Surface double plate

WALL-MOUNT DEVICES

FENIX NTM®

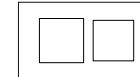
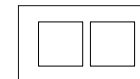
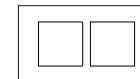
Series	Window	Colour	Code
20venti FF 71		malè white	EK-S2G-FBM
		beige luxor	EK-S2G-FBL
		beaver ottawa	EK-S2G-FCO
		cocoa orinoco	EK-S2G-FCC
		grey efeso	EK-S2G-FGE
		grey london	EK-S2G-FGL
		grey bromine	EK-S2G-FGB
		green commodore	EK-S2G-FVC
		black ingo	EK-S2G-FNI
		malè white	EK-S2S-FBM
		beige luxor	EK-S2S-FBL
		beaver ottawa	EK-S2S-FCO
	cocoa orinoco	EK-S2S-FCC	
	grey efeso	EK-S2S-FGE	
	grey london	EK-S2S-FGL	
	grey bromine	EK-S2S-FGB	
	green commodore	EK-S2S-FVC	
	black ingo	EK-S2S-FNI	



DIN-RAIL MOUNT MODULES

Power supplies	250
System devices	253
Universal interface	258
Inputs	266
I/O Modules	273
Dimmer	276
Thermal regulation and PLC	287
Gateway	295
Metering	308



Power supply units

DIN-RAIL MOUNT MODULES

	EK-AB1-TP 640 mA bus power supply	EK-AG1-TP 640 mA bus power supply with 30 Vdc auxiliary output	EK-AM1-TP 1280 mA bus power supply
Max. number of KNX devices that can be connected on KNX bus supply line	64	64	256
Reset of the connected bus line through pushbutton	•	•	•
LED for output voltage on KNX bus	•	•	•
LED for overload / short circuit on KNX bus	•	•	•
Integrated decoupling choke	•	•	•
Power supply 230 Vac	•	•	•
Power supply 176 - 280 Vdc	-	-	•
Output for auxiliary power supply 30 Vdc	-	•	•
Mounting on standard 35 mm rail (EN 60715)	•	•	•

System devices

DIN-RAIL MOUNT MODULES

	EK-TM1-TP Time / astronomical digital switch	EK-BD1-TP USB interface	EK-BA1-TP Line / area coupler	EK-IE1-SEC-TP IP secure interface	EK-IF1-SEC-TP IP secure router
Suppress device configuration on the sub line	-	-	•	•	•
Enable or disable filtering of group messages and suppress device oriented messages	-	-	•	•	•
Trace the traffic on the sub line and reduced number of retransmissions	-	-	•	•	•
Function pushbutton	•	-	•	•	•
Status LED for KNX bus line	-	•	•	•	•
Status LED for Ethernet	-	-	-	•	•
Mounting on standard 35 mm rail (EN 60715)	•	•	•	•	•
Plug in program	•	-	•	•	•
Programming pushbutton	-	•	-	•	•
Connection of a PC or laptop to the KNX bus system	-	-	-	•	•
Secure features	-	-	-	•	•
Time programming (daily, weekly, monthly or yearly) or astronomical	•	-	-	-	-
Control of 9 channels on bus	•	-	-	-	-
Channel 1 can be replicated on the relay on board	•	-	-	-	-
LCD-display	•	-	-	-	-
Backup battery	•	-	-	-	-
Connection of an optional GPS module	•	-	-	-	-



Description

The Ekinex® 640 mA KNX bus power supply supplies and monitors the 30 Vdc voltage required by the KNX bus for operation. An integrated choke provides for decoupling power supply and bus line. On a bus line powered by a 640 mA power supply unit may be connected a maximum of 64 bus devices. Output is protected from overload and short-circuit. The EK-AG1-TP version is provided with an additional 30 Vdc output can be used as auxiliary power supply for other devices requiring SELV voltage (Safety Extra Low Voltage). The total current provided by the two outputs (KNX bus line and auxiliary power supply) cannot exceed 640 mA. The device supports short network voltage interruptions (max. 200 ms).

Main features

- Plastic casing
- Connection to bus line with KNX terminal block
- Connection of auxiliary output with dedicated terminal block (only EK-AG1-TP)
- Connection of 230 Vac power supply with screw terminals
- Classification climatic 3K5 and mechanical 3M2 (according to EN 50491-2)
- Pollution degree 2 (according to IEC 60664-1)
- Safety class II
- Installation on 35 mm rail (according to EN 60715)
- 4 modular units (1 MU = 18 mm)
- IP20 protection grade (installed device)
- Weight 150 g (EK-AB1-TP), 165 g (EK-AG1-TP)

Order information

Code	Version	Package
EK-AB1-TP		1 pcs.
EK-AG1-TP	with 30 Vdc auxiliary output	1 pcs.

640 mA bus power supply

POWER SUPPLY UNITS

Technical data

- Input voltage: 230 Vac, 50/60 Hz
- Power absorption 22 W
- Loss < 3 W
- Output voltage (KNX bus): 30 Vdc
- Output voltage (auxiliary output): 30 Vdc (only EK-AG1-TP)
- Nominal current (output total): 640 mA
- Buffer time: 200 ms

Delivery

Delivery includes one terminal blocks for connection to the bus: the EK-AG1-TP version is delivered with a second terminal block for connection to the auxiliary output.

Dimensions [mm]

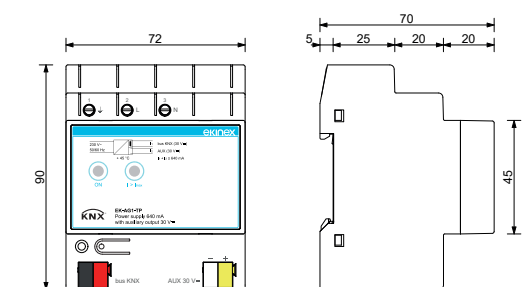

Terminal block for auxiliary output (white/yellow) only on EK-AG1-TP version

Configuration and commissioning

Not necessary

Documentation

For more information see the technical documentation, download from www.ekinex.com



EK-AB1-TP EK-AG1-TP



1280 mA bus power supply

POWER SUPPLY UNITS

Description

The Ekinex® EK-AM1-TP power supply produces and monitors the 30 Vdc voltage required for operation of the KNX bus system. A coil integrated in the device decouples the power supply from the bus line. The output has overload and short-circuit protection. It has an additional 30 Vdc output that can be used for auxiliary supply of other SELV devices. The total current provided by the two outputs (KNX bus line and auxiliary power supply) cannot exceed 1280 mA. The device is capable of supporting short mains voltage interruptions (max. 200 ms).

Main features

- Plastic housing
- Connection to bus line via KNX terminal
- Auxiliary power connection via dedicated screw terminals
- Power supply connection via screw terminals
- Degree of protection IP 20 (device installed)
- Climatic classification 3K5 and mechanical classification 3M2 (according to EN 50491-2)
- Pollution degree 2 (according to IEC 60664-1)
- Safety class I
- Mounting on 35 mm profile rail (according to EN 60715)
- Device with 4 modular units (1 UM = 18 mm)
- Weight 320 g

Technical data

- Supply voltage 230 Vac, 50/60 Hz
- Power consumption 39 W
- Losses < 3 W
- Voltage on bus line: 30 Vdc +1/-2 Vdc SELV
- Voltage on auxiliary output: 30 Vdc
- Nominal current: 1280 mA
- Buffer time: 200 ms

Delivery

Delivery includes one terminal blocks for connection to the bus.

Dimensions [mm]

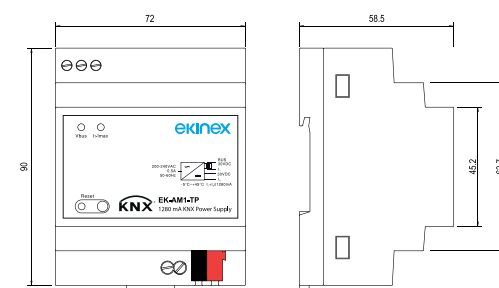

Order information

Code	Package
EK-AM1-TP	1 pcs.



Documentation

For more information see the technical documentation, download from www.ekinex.com



Time / astronomical digital switch

SYSTEM DEVICES

Description

The EK-TM1-TP electronic digital time switch is a KNX device for the management over time of the electrical devices. It allows time programming (periodicity: daily, weekly or annual) or astronomical programming. The device can pilot 9 different channels on KNX bus. The relay on the device replicates the channel 1 programming. Each channel can be associated with a different programming (time or astronomical). It is possible to connect via bus the EK-GPS-1 module (to be ordered separately), that captures the time and the position through the satellite system, ensuring a greater accuracy over time. The backup battery keeps the settings even in case of power failure and can be replaced through the cover (sealable).

Main features

- Plastic casing
- LCD with backlight (active only with AC power supply)
- Password lockable keyboard
- 450 storable programs (900 events) divisible on 9 channels
- Daily/weekly/monthly/yearly + astronomical programming
- On/off, pulse, holiday, random, night (astronomical) programmes
- Programming resolution 1 minute
- Actions type 1B
- Automatic update of daylight saving time (configurable)
- Connection to bus line with KNX terminal block
- Screw terminal blocks for connecting 230 Vac, output and GPS module
- Lithium backup battery: 3V, CR14250 type (5-years life, replaceable)
- Reinforced insulation between accessible parts (front) and all the other terminals
- Protection degree IP20 (device installed)
- Mounting on 35 mm standard DIN-rail (according to EN 60715)
- 3 modular units (1 UM = 18 mm)

Technical data

- Power supply: 115 ÷ 230 Vac (-15% ÷ +10%) 50/60 Hz
- Power consumption: 7 VA (2.6 W)

Output

- 1 monostable switching relay 16(10) A at 250 Vac

Delivery

Delivery includes a terminal block for connection to the bus. The optional module EK-GPS-1 has to be ordered separately.

Dimensions [mm]

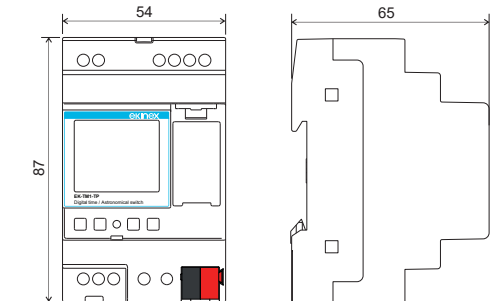

Order information

Code	Package
EK-TM1-TP	1 pcs.
EK-GPS-1	



Configuration and commissioning

By means of ETS5 software or later versions
Application program: **APEKTM1TP##.knxprod**
(## = version, downloadable from www.ekinex.com)



Documentation

For more information see the technical documentation, download from www.ekinex.com



EK-TM1-TP EK-GPS-1



USB interface

SYSTEM DEVICES

Description

The Ekinex® USB interface EK-BD1-TP allows a bidirectional data connection between a PC and a KNX bus system. The device handles the addressing, parameter setting, display, protocol management and diagnosis of KNX bus devices. The device integrates a KNX bus communication module and is realized for mounting on a standard 35 mm DIN-rail.

Main features

- Plastic casing
- LEDs indicators for data transmission on USB and KNX bus status
- Connection to bus line with KNX terminal block
- Connection to PC with USB type B connector
- Installation on 35 mm rail (according to EN 60715)
- 2 modular units (1 MU = 18 mm)
- IP20 protection degree (installed device)
- Weight 100 g

Technical data

- Power supply (bus side): 30 Vdc SELV, current consumption: max. 10 mA
- Power supply (PC side): from USB, current consumption: max. 20 mA

Delivery

Delivery includes a terminal block for connection to the bus.

Dimensions [mm]

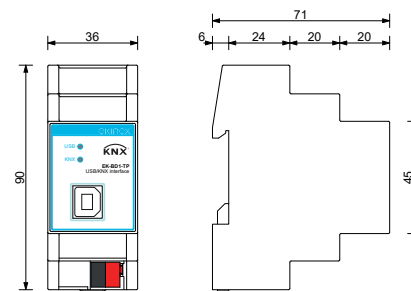

Line / area coupler

SYSTEM DEVICES

Description

The Ekinex® line / area coupler EK-BA1-TP can be used as a line coupler to connect a secondary line to a main line, as an area coupler to connect a main line to a backbone line or as a repeater. The device assures galvanic insulation between the two connected lines and filters the traffic based on installation position or on filter tables in case of group-oriented communications. The frontal LEDs indicate the status of each bus line and facilitate the tracing of communication problems due to bus load or to re-transmission on both lines. The device integrates a KNX bus communication module and is realized for mounting on a standard 35 mm DIN-rail.

Main features

- Plastic casing
- Frontal programming pushbutton and LED
- LEDs indicators for status of KNX bus lines
- Pushbutton for activating special functions
- Connection to bus lines with KNX terminal blocks
- Installation on 35 mm rail (according to EN 60715)
- 2 modular units (1 MU = 18 mm)
- IP20 protection degree (installed device)
- Weight 100 g

Technical data

- 30 Vdc power supply by KNX bus
- Current consumption (from main bus line) ca.10 mA

Functions

- Suppress device configuration on the sub line
- Enable or disable filtering of group messages
- Suppress device oriented messages
- Trace the traffic on the sub line
- Reduced number of retransmissions

Delivery

Delivery includes two terminal blocks for connection to the bus lines.

Dimensions [mm]

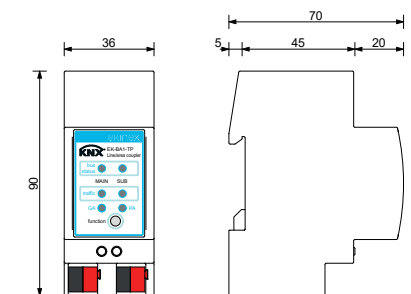

Order information

Code	Package
EK-BD1-TP	1 pcs.



Configuration and commissioning

Not necessary; the application program **APEKBD1TP#.#.vd4** (download from www.ekinex.com) is available for an ETS project.



Documentation

For more information see the technical documentation, download from www.ekinex.com



Order information

Code	Package
EK-BA1-TP	1 pcs.



Configuration and commissioning

By means of ETS5 software or later versions
Application program **APEKBA1TP#.#.vd4** (download from www.ekinex.com)



Documentation

For more information see the technical documentation, download from www.ekinex.com





IP secure interface

SYSTEM DEVICES

Description

The Ekinex® EK-IE1-SEC-TP IP interface realises a bidirectional data connection between a PC or laptop and a KNX bus system via a LAN network. The IP interface supports the tunnelling protocol and allows addressing, parameter setting, visualisation, protocolling and diagnosis of KNX bus devices via ETS. The device has an integrated KNX bus communication module and is designed for mounting on a 35 mm profile rail. The power supply is supplied via the KNX bus. As a secure interface, the device prevents unauthorised access to the system.

Main features

- Plastic housing
- Programming button and LED on the front panel
- LEDs for status and data traffic indication on bus line and Ethernet network
- Buttons for activating special functions
- Connection to bus line via KNX terminal
- Connection to Ethernet network via RJ45 connector
- Mounting on 35 mm profile rail (in accordance with EN 60715)
- Device from 1 modular unit (1 UM = 18 mm)
- IP20 degree of protection (device installed)
- Support of KNX secure technology, can be activated via ETS®.

Technical data

- Power supplied via KNX bus (21-30 Vdc)
- Current consumption 20 mA from KNX bus
- Up to 8 KNXnet/IP connections simultaneously
- Operating temperature: - 5 ... + 45°C
- Relative humidity: 5-93% non-condensing

Delivery

Delivery includes a terminal block for connection to the bus.

Dimensions [mm]

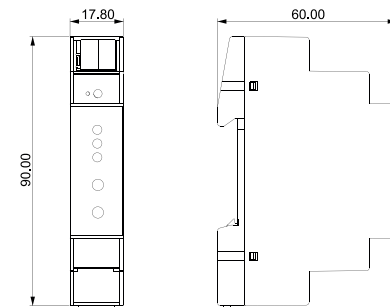

Order information

Code	Package
EK-IE1-SEC-TP	1 pcs.



Configuration and commissioning

By means of ETS5 software or later versions
Application programs **APEKIE1SECTP##.knxprod** (download from www.ekinex.com)



Documentation

For more information see the technical documentation, download from www.ekinex.com



IP secure router

SYSTEM DEVICES

Description

The Ekinex® EK-IF1-SEC-TP IP router realises a bi-directional data connection between a PC or laptop and a KNX bus system via a LAN. The IP interface supports the tunnelling protocol and allows addressing, parameter setting, visualisation, protocolling and diagnosis of KNX bus devices via ETS. A line/area coupler function is also integrated in the IP router; telegrams can be exchanged between KNX TP bus lines via the device via a backbone over TCP/IP. The device has an integrated KNX bus communication module and is designed for 35 mm profile rail mounting. The power supply is supplied via the KNX bus.

Main features

- Plastic housing
- Programming button and LED on the front
- LEDs for status and data traffic signalling on bus line and Ethernet network
- Buttons for activating special functions
- Connection to bus line via KNX terminal
- Connection to Ethernet network via RJ45 connector
- Mounting on 35 mm profile rail (in accordance with EN 60715)
- Device from 1 modular unit (1 UM = 18 mm)
- IP20 degree of protection (device installed)
- Support of KNX secure technology, can be activated via ETS®
- KNX line/area coupler functionality

Technical data

- Power supplied via KNX bus (21-30 Vdc)
- Current consumption 20 mA from KNX bus
- Up to 8 KNXnet/IP connections simultaneously
- Extended filter table for main groups 0..31
- Operating temperature: - 5 ... + 45°C
- Relative humidity: 5-93% non condensing

Delivery

Delivery includes a terminal block for connection to the bus.

Dimensions [mm]

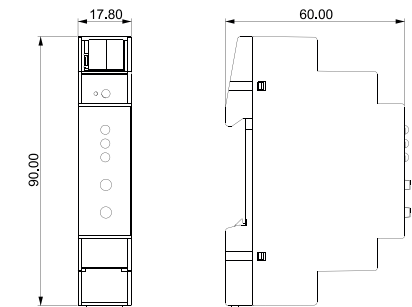

Order information

Code	Package
EK-IF1-SEC-TP	1 pcs.



Configuration and commissioning

By means of ETS5 software or later versions
Application programs **APEKIF1SECTP##.knxprod** (download from www.ekinex.com)



Documentation

For more information see the technical documentation, download from www.ekinex.com



Universal interfaces

RAIL AND FLUSH-MOUNTING DEVICES

EK-LM2-TP 4 IN | EK-CC2-TP 2 IN / 2 OUT | EK-CD2-TP 4 IN / 4 OUT | EK-CG2-TP 4 IN conf. AI for NTC probes or DI / 4 OUT | EK-CE2-TP 4 IN conf. / 2 OUT relay 5A | EK-CF2-TP for load monitoring and control

	EK-LM2-TP 4 IN	EK-CC2-TP 2 IN / 2 OUT	EK-CD2-TP 4 IN / 4 OUT	EK-CG2-TP 4 IN conf. AI for NTC probes or DI / 4 OUT	EK-CE2-TP 4 IN conf. / 2 OUT relay 5A	EK-CF2-TP for load monitoring and control
Input channels [DI]	4	2	4	-	3	-
Channels configurable as input [DI] or output [DO] for low-consumption LEDs	-	-	-	-	-	-
Input channels configurable as [AI] for NTC probes or [DI]	-	-	-	4	1	-
Input channels for current transformers EK-TA-...	-	-	-	-	-	3
Output channels for low-consumption LEDs	-	2	4	4	-	-
Output channels relay (5A)	-	-	-	-	2	-
ON/OFF command of single or grouped loads	-	•	•	•	•	-
Dimming command of lighting devices	-	•	•	•	•	-
Actuator command of shutters, blinds, venetians, etc.	-	•	•	•	•	-
Detection of the status of the indication contacts	•	•	•	•	•	-
Sending and storing of scenes	-	•	•	•	•	-
Logic functions (AND, OR or XOR), 4 channels	•	•	•	•	•	•
Room thermostat function	-	-	-	•	•	-
Pulse and actuator counting	-	•	•	•	•	-
Mounting on 35 mm standard DIN rail (EN 60715) through support EK-SMG-35	•	•	•	•	•	•



Description

The configurable logical module Ekinex® EK-LM2-TP is a KNX S-mode device that can be used to perform logic and data processing functions on data exchanged on the KNX bus. The device is suitable for mounting in wall box or on 35 mm rail (EN 60715) with the support EK-SMG-35 included in the delivery. To be used in KNX installations for home and building automation. The device is powered by the KNX bus line with a SELV voltage 30 Vdc and does not require auxiliary power.

Main features

- Plastic housing
- Wall installation in flush mounting box or, with a mounting support, on 35 mm rail (according to EN 60715)
- Protection degree IP20 (installed device)
- Classification climatic 3K5 and mechanical 3M2 (according to EN 50491-2)
- Pollution degree 2 (according to IEC 60664-1)
- Weight 20 g

Functions

The device implements independent blocks of the below listed types:

- **Logic:** Combines a number of boolean inputs according to logic operations.
- **Arithmetic:** Performs mathematical computations on one or more input values.
- **Range:** Performs a scaling of the input value to a different range of values, or a boundary limit.
- **Mapping:** Translates a set of input values (up to 8 points) to a different set of output values.
- **Conversion:** Converts a KNX communication object to another one with a different KNX data type (DPT).
- **Timer:** Implements a one-shot (monostable) or free running (stable) timer, with configurable on- and off-delay times.
- **Compare:** Returns the result of a comparison (equal, larger, smaller etc.) between two input values
- **Multiplexer:** Copies the value of one input object to either 1 of N output objects, or to all objects selected in the output set.

Order information

Code	Version	Package
EK-LM2-TP	4 IN	1 pcs.

Configurable logical module

UNIVERSAL INTERFACES

Each function can be configured in different ways by means of parameters in the ETS application. There are several independent instances available for each type of block, therefore the device can be used to fulfill many requirements or to solve a large number of contingencies in the same installation. An additional terminal block allows the connection of up to 4 dry contacts for simple external inputs.

Power supply

- 30 Vdc power supply by KNX bus
- Current consumption from bus < 10 mA

Delivery

Delivery includes a terminal block for connection to the bus.

Accessories

Support for mounting on a standard 35 mm DIN-rail (code EK-SMG-35) and spring for snapping on the back of Ekinex® wall-mount devices (code EK-MAR-...) to be ordered separately.

Dimensions [mm]

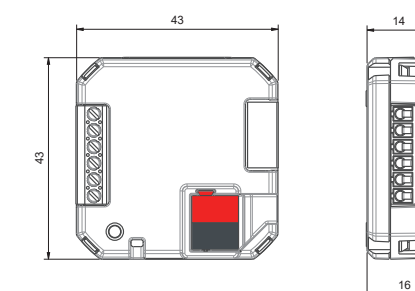

Configuration and commissioning

By means of ETS5 software or later versions
Application program **APEKLM2TP##.knxprod** (download from www.ekinex.com)



Documentation

For more information see the technical documentation, download from www.ekinex.com





Universal interface 2 (4) IN, 2 (4) OUT

UNIVERSAL INTERFACES



Universal interface 4 configurable IN, 4 OUT

UNIVERSAL INTERFACES

Description

The Ekinex® universal interface is a KNX device which can be used as input and/or output module. The device is equipped with:

- inputs to connect the KNX bus to switches, pushbuttons or classic sensors (normally not communicating on the KNX bus) or any binary signals from other devices, in order to control KNX bus functions;
- control outputs for low consumption LEDs.

The voltage for polling the inputs is supplied within the device. The device integrates a KNX bus communication module and is realized for flush-mounting or for mounting on a standard 35 mm DIN-rail. The device is powered by the KNX bus and does not require auxiliary power supply.

Main features

- Plastic casing
- Programming pushbutton and LED on the case
- Connection to bus line with KNX terminal block
- Screw terminal blocks for connecting inputs and outputs
- IP20 protection degree (installed device)
- Weight 20 g

Power supply

- 30 Vdc power supply by KNX bus
- Current consumption from bus < 10 mA

Delivery

Delivery includes a terminal block for connection to the bus.

Accessories

Support for mounting on a standard 35 mm DIN-rail (code EK-SMG-35) and spring for snapping on the back of Ekinex® wall-mount devices (code EK-MAR-...) to be ordered separately.

Dimensions [mm]

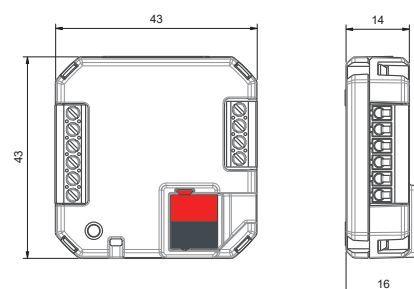

Description

The Ekinex® EK-CG2-TP pushbutton interface is a KNX device which can be used as input and/or output module. The device is equipped with 4 configurable inputs and 4 control outputs for low consumption LEDs.

Inputs can be independently configured to connect the KNX bus to:

- switches, pushbuttons, classic sensors (normally not communicating on the KNX bus) or any binary signals from other devices, in order to control KNX bus functions;
- passive temperature sensors (NTC 10 kΩ at 25°C). The environment air mass temperature value, measured by those sensors, can be sent onto the bus or be used to control a room or zone temperature through the integrated thermostat function.

The voltage for polling the inputs is supplied within the device. The device integrates a KNX bus communication module and is realized for flush-mounting or for mounting on a standard 35 mm DIN-rail. The device is powered by the KNX bus and does not require auxiliary power supply.

Main features

- Plastic casing
- Programming pushbutton and LED on the case
- Connection to bus line with KNX terminal block
- Screw terminal blocks for connecting inputs and outputs
- IP20 protection degree (installed device)
- Weight 20 g

Power supply

- 30 Vdc power supply by KNX bus
- Current consumption from bus < 10 mA

Delivery

Delivery includes a terminal block for connection to the bus. The NTC temperature sensors (page 231) for those channels configured as [AI] must be ordered separately.

Accessories

Support for mounting on a standard 35 mm DIN-rail (code EK-SMG-35) and spring for snapping on the back of Ekinex® wall-mount devices (code EK-MAR-...) to be ordered separately.

Dimensions [mm]

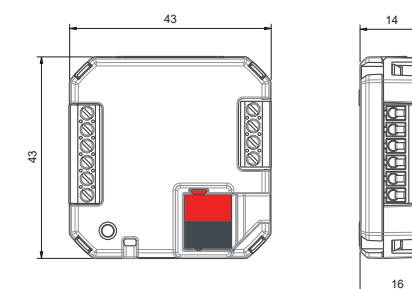

Order information

Code	Version	Package
EK-CC2-TP	2 IN / 2 OUT	1 pcs.
EK-CD2-TP	4 IN / 4 OUT	



Configuration and commissioning

By means of ETS5 software or later versions
Application program **APEKCC2TP##.knxprod** (EK-CC2-TP) or
APEKCD2TP##.knxprod (EK-CD2-TP) (download from www.ekinex.com)



Documentation

For more information see the technical documentation, download from www.ekinex.com



EK-CC2-TP EK-CD2-TP

Order information

Code	Version	Package
EK-CG2-TP	4 IN / 4 OUT	1 pcs.



Configuration and commissioning

By means of ETS5 software or later versions
Application program **APEKCG2TP##.knxprod** (download from www.ekinex.com)



Documentation

For more information see the technical documentation, download from www.ekinex.com





Universal interface 4 IN, 2 OUT (relay 5A)

UNIVERSAL INTERFACES

Description

The Ekinex® universal interface EK-CE2-TP is a KNX device which can be used as input and/or output module. The device is equipped with:

- 4 inputs to connect the KNX bus to switches, pushbuttons or classic sensors (normally not communicating on the KNX bus) or any binary signals from other devices, in order to control KNX bus functions. In addition, one input is configurable as analogue to connect a NTC temperature sensor (10 kΩ a 25 °C);
- 2 5A relay outputs to be used as electrical load control (independent) or paired for shutter and blind actuator control.

The voltage for polling the inputs is supplied within the device. The device integrates a KNX bus communication module and is realized for flush-mounting or for mounting on a standard 35 mm DIN-rail. The device is powered by the KNX bus and does not require auxiliary power supply.

Main features

- Plastic casing
- Programming pushbutton and LED on the case
- Connection to bus line with KNX terminal block
- Screw terminal blocks for connecting inputs and outputs
- IP20 protection degree (installed device)
- Weight 35 g

Power supply

- 30 Vdc power supply by KNX bus
- Current consumption from bus < 10 mA

Delivery

Delivery includes a terminal block for connection to the bus. The NTC temperature sensors (page 231) for those channels configured as [AI] must be ordered separately.

Accessories

Support for mounting on a standard 35 mm DIN-rail (code EK-SMG-35) and spring for snapping on the back of Ekinex® wall-mount devices (code EK-MAR-...) to be ordered separately.

Dimensions [mm]

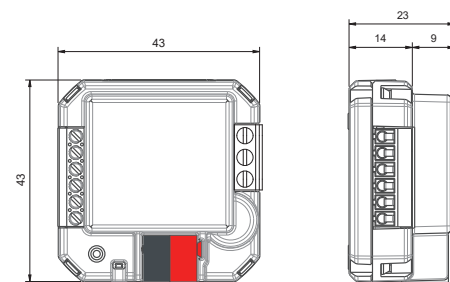

Order information

Code	Package
EK-CE2-TP	1 pcs.



Configuration and commissioning

By means of ETS5 software or later versions
Application program **APEKCE2TP#.#knxprod**
(download from www.ekinex.com)



Documentation

For more information see the technical documentation,
download from www.ekinex.com



Load monitoring and control interface

UNIVERSAL INTERFACES

Description

The Ekinex® EK-CF2-TP interface for load monitoring and control is a KNX devices which can be used to:

- measure the instantaneous current absorbed by (up to) three single-phase or one three-phase electrical circuits;
- control electrical loads with priority disconnection and reconnection.

The current measurement is performed by means of max three Ekinex® EK-TA-... current transformers. The device is powered by the KNX bus and does not require auxiliary power supply. Flush-mounting or mounting on a standard 35 mm DIN-rail by means of a support included in the delivery.

Main features

- Plastic casing
- Programming pushbutton and LED on the case
- Connection to bus line with KNX terminal block
- Connection to current transformers by means of a 6-wire screw terminal block
- IP20 protection degree (installed device)
- Weight 20 g

Functional characteristics

- Connection to current transformers EK-TA-... by means of 3 physical inputs
- Possibility to measure (up to) three single-phase or one three-phase lines;
- Possibility to receive power values from bus
- 8 general purpose power thresholds
- 4 4-channel logic functions (AND, OR or XOR)

Load monitoring

- Direct measurement of instantaneous current by means of transformers EK-TA-...
- Calculation of instantaneous power
- Total electricity metering
- Sending on the bus of measured current, power and energy values

Order information

Code	Package
EK-CF2-TP	1 pcs.

Load control

- Possibility to independently handle up to 8 loads for each channel
- Configurable power threshold for load control and related hysteresis
- Sending on the bus of an indication when the threshold is reached
- Possibility to exclude loads from the bus
- Disconnection and reconnection delay independently configurable for each channel

Power supply

- 30 Vdc power supply by KNX bus
- Current consumption from bus < 10 mA

Delivery

Delivery includes a terminal block for connection to the bus and a support for mounting on a standard 35 mm DIN-rail. Current transformers EK-TA-... must be ordered separately.

Dimensions [mm]

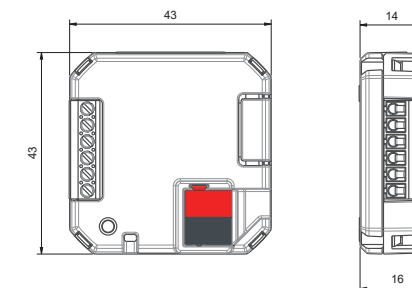

Configuration and commissioning

By means of ETS5 software or later versions
Application program **APEKCF2TP#.#knxprod**
(download from www.ekinex.com)



Documentation

For more information see the technical documentation,
download from www.ekinex.com





Current transformer (TA) for EK-CF2-TP interface

ACCESSORIES FOR UNIVERSAL INTERFACES

Description

Current transformer (TA) to used in combination with an Ekinex® EK-CF2-TP load monitoring and control interface.

Main features

- Plastic casing
- Ferrite core
- 1,5 m connecting cable with free ends
- Weight: 55 g

Technical data

- Nominal voltage: 0...1 Vac
- Precision: ±1 %
- Linearity: ≤ 0,2 %
- Operation frequency: 50...1KHz
- Dielectric resistance (50 Hz, 1 min): 3 KV
- Fire resistance: UL 94-V0

Dimensions [mm]

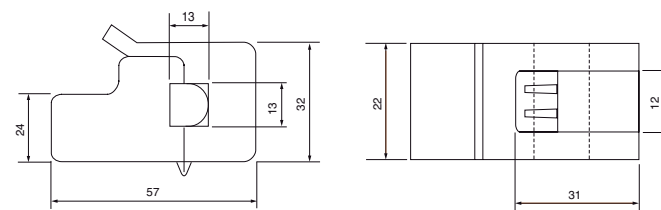

Order information

Code	Nominal current [A]	Package
EK-TA-05A	0...5	1 pcs.
EK-TA-20A	0...20	
EK-TA-30A	0...30	
EK-TA-40A	0...40	
EK-TA-50A	0...50	
EK-TA-60A	0...60	



Configuration and commissioning

The device does not require any configuration. The used version must be set in the application program of the EK-CF2-TP interface.



Documentation

For more information see the technical documentation, download from www.ekinex.com



Description

Support for mounting universal interfaces (except EK-CB2-TP) on a standard 35 mm DIN-rail.

Order information

Code	Package
EK-SMG-35-1	1 pcs.
EK-SMG-35-5	5 pcs.

Support for DIN-rail mounting

ACCESSORIES FOR UNIVERSAL INTERFACES



Description

Spring for snapping universal interfaces (except EK-CB2-TP) on the back of Ekinex® wall-mount devices.

Order information

Code	Package
EK-MAR-1	1 pcs.
EK-MAR-5	5 pcs.

Spring for snapping on wall-mount devices

ACCESSORIES FOR UNIVERSAL INTERFACES



Inputs

DIN-RAIL MOUNT MODULES

	EK-CA1-TP 8-fold analogue/binary input
ON / OFF switching of individual loads or groups of loads	•
Dimming control for lighting devices	•
Operating control for shutters and roller blinds	•
Detecting the status of signaling contacts	•
Recalling and saving of scenes	•
Pushbutton for toggling between manual and automatic operation	•
Pushbuttons for forced operation of the inputs	•
Counting of impulses and switching cycles	•
Mounting on standard 35 mm rail (EN 60715)	•
Connection of potential-free contacts or NTC passive temperature sensors	•



Description

The Ekinex® EK-CA1-TP binary input has 8 independent input channels for connecting to the KNX bus commands and sensors of traditional type, having potential-free contacts or NTC passive temperature sensor. Thanks to the binary input, it is possible to command and control bus functions with standard switches, pushbuttons or sensors (not natively communicating with the KNX bus) or binary signals made available by other devices. The query voltage of input channels is produced within the device. The device integrates a KNX bus communication module and is realized for mounting on a standard 35 mm DIN-rail. The device is supplied by the KNX bus and does not require auxiliary power supply.

Main features

- Plastic casing
- ON/OFF switching of single loads or group of loads
- Detecting the state of signaling contacts (from safety devices, alarms, etc.)
- Recalling and saving of scenes
- Sending on the bus of values (temperature, brightness, etc.)
- Switching to forced functioning (lock)
- Counting of impulses and switching cycles
- Dimming of lighting devices
- Operating of shutters and roller blinds
- Measuring of the air mass temperature with a ntc passive temperature sensor (ntc 10 kw at 25 °c) with possibility of sending the value on the bus
- 2 Points (on / off) or proportional (pwm or continuous) room temperature regulation
- 4 Logic functions (and, or, xoR) with 4 logic objects in input each
- Frontal programming pushbutton and LED
- Membrane keyboard with LED's for status indication
- Pushbutton for switching operating mode (normal / programming)
- Connection to bus line with KNX terminal block
- Connection of inputs with screw terminals
- Installation on 35 mm rail (according to EN 60715)

Order information

Code	Package
EK-CA1-TP	1 pcs.

8-fold analogue/binary input

INPUTS

- 4 modular units (1 MU = 18 mm)
- IP20 protection degree (installed device)
- Weight 145 g

Technical data

Power supply

- Voltage 30 Vdc by KNX bus
- Current consumption from bus < 13 mA
- Power on bus 320 mW

Inputs

- Number: 8
- Query voltage: < 11 V
- Query current: < 5 mA

Delivery

Delivery includes a terminal block for connection to the bus.

Dimensions [mm]

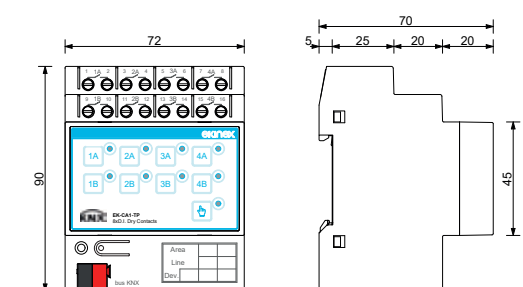

Configuration and commissioning

By means of ETS5 software or later versions
Application program **APEKCA1TP#.#.knxprod**
(download from www.ekinex.com)



Documentation

For more information see the technical documentation,
download from www.ekinex.com



Actuators

DIN-RAIL MOUNT MODULES

EK-FA1-TP 4-fold binary output	EK-FB1-TP 8-fold binary output	EK-FE1-TP 8-fold binary output / 4-fold blind actuator	EK-FF1-TP 16-fold binary output / 8-fold blind actuator
--------------------------------------	--------------------------------------	---	--

ON / OFF switching of individual loads or groups of loads	•	•	•	•
Configurable as normally open or normally closed switch	•	•	•	•
Logical gates and forced mode for each channel	•	•	•	•
Manual control by membrane pushbuttons	-	-	•	•
Manual control by levers (also without bus voltage)	•	•	-	-
Status feedback of output channels through the position of the levers	•	•	-	-
Status feedback of output channels through LEDs	-	-	•	•
Switching pushbutton manual / automatic mode	-	-	•	•
Block function for each channel	-	-	•	•
Auxiliary power supply	-	-	•	•
Time scheduling: switching delay for on and off, staircase lighting function	•	•	•	•
Management of scenarios	•	•	•	•
Operating hours counter configurable via bus	•	•	•	•
Shutters / blinds operation mode	-	-	•	•
Automatic control for protection against direct sunlight	-	-	•	•
Automatic control for protection against weather conditions (rain, wind, frost)	-	-	•	•
Mounting on standard 35 mm rail (EN 60715)	•	•	•	•



Description

The Ekinex® EK-FA1-TP binary output allows to command 4 groups of loads independently; to this purpose, the device has outputs fitted with potential-free relays. The device's latching relays guarantee the upkeep of command status even in the case of bus power failures. The front levers indicate the status of each output channel and, in case of emergency, allow manual command (by means of a tool) of the loads. The device integrates a KNX bus communication module and is realized for mounting on a standard 35 mm DIN-rail. The device is supplied by the KNX bus and does not require auxiliary power supply.

Main features

- Plastic casing
- Frontal programming pushbutton and LED
- Connection to bus line with KNX terminal block
- Connection of outputs with screw terminals
- Overvoltage class III (according to EN 60664-1)
- Classification climatic 3K5 and mechanical 3M2 (according to EN 50491-2)
- Pollution degree 2 (according to IEC 60664-1)
- Installation on 35 mm rail (according to EN 60715)
- 4 modular units (1 MU = 18 mm)
- IP20 protection degree (installed device)
- Weight 205 g

Order information

Code	Package
EK-FA1-TP	1 pcs.

4-fold binary output

ACTUATORS

Technical data

Power supply

- 30 Vdc voltage by KNX bus
- Current consumption from bus < 12 mA
- Power from bus 360 mW

Outputs

- 4 latch relays
- Nominal voltage (U_n): 100-230Vac, 50/60Hz
- Nominal current (I_n): max 10 A (both @100Vac and @230Vac)
- Switched power: 1000W @100Vac - 2200 W @230Vac

Delivery

Delivery includes a terminal block for connection to the bus.

Dimensions [mm]

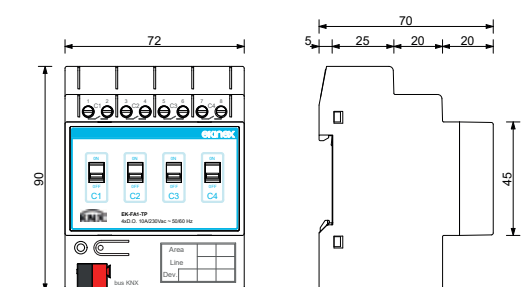

Configuration and commissioning

By means of ETS5 software or later versions
Application program **APEKFA1TP##.knxprod**
(download from www.ekinex.com)



Documentation

For more information see the technical documentation,
download from www.ekinex.com



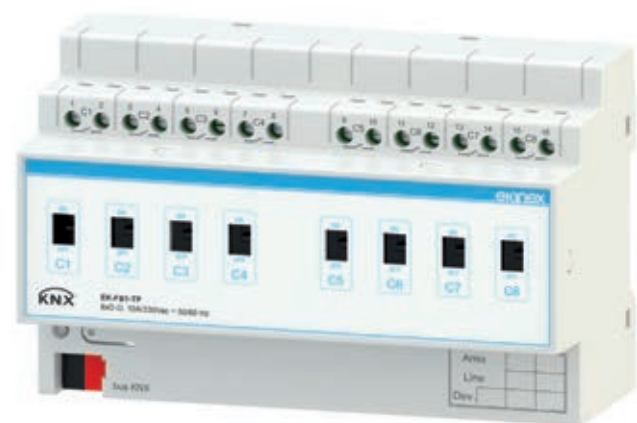

8-fold binary output

ACTUATORS

Description

The Ekinex® EK-FB1-TP binary output allows to command 8 groups of loads independently; to this purpose, the device has outputs fitted with potential-free relays. The device's latching relays guarantee the upkeep of command status even in the case of bus power failures. The front levers indicate the status of each output channel and, in case of emergency, allow manual command (by means of a tool) of the loads. The device integrates a KNX bus communication module and is realized for mounting on a standard 35 mm DIN-rail. The device is supplied by the KNX bus and does not require auxiliary power supply

Main features

- Plastic casing
- Frontal programming pushbutton and LED
- Connection to bus line with KNX terminal block
- Connection of outputs with screw terminals
- Overvoltage class III (according to EN 60664-1)
- Classification climatic 3K5 and mechanical 3M2 (according to EN 50491-2)
- Pollution degree 2 (according to IEC 60664-1)
- Installation on 35 mm rail (according to EN 60715)
- 8 modular units (1 MU = 18 mm)
- IP20 protection degree (installed device)
- Weight 385 g

Technical data

Power supply

- 30 Vdc voltage by KNX bus
- Current consumption from bus < 12 mA
- Power from bus 360 mW

Outputs

- 4 latch relays
- Nominal voltage (U_n): 100-230Vac, 50/60Hz
- Nominal current (I_n): max 10 A (both @100Vac and @230Vac)
- Switched power: 1000W @100Vac - 2200 W @230Vac

Delivery

Delivery includes a terminal block for connection to the bus.

Dimensions [mm]

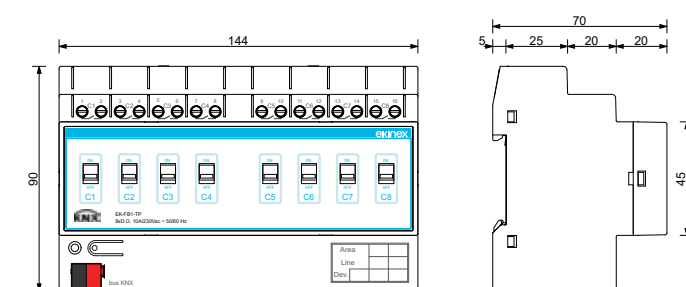

Order information

Code	Package
EK-FB1-TP	1 pcs.



Configuration and commissioning

By means of ETS5 software or later versions
Application program **APEKFB1TP##.knxprod**
(download from www.ekinex.com)



Documentation

For more information see the technical documentation, download from www.ekinex.com



8-fold binary output/ 4-fold blind actuator

ACTUATORS

Description

The Ekinex® EK-FE1-TP binary output / blind actuator allows to command 8 groups of loads or control 4 drives for motorised blinds independently. The device is fitted with membrane pushbuttons for manual command (even in the absence of bus power) and LED's for status indication: a pushbutton allows to switch between automatic and manual operation modes. The device integrates a KNX bus communication module and is realized for mounting on a standard 35 mm DIN-rail. The device is supplied by the KNX bus and requires an additional 230 Vac power supply to operate.

Main features

- Plastic casing
- Frontal programming pushbutton and LED
- Membrane keyboard with LED's for status indication
- Pushbutton for switching operating mode (normal / programming)
- Connection to bus line with KNX terminal block
- Connection of outputs and 230 Vac power supply with screw terminals
- Overvoltage class III (according to EN 60664-1)
- Classification climatic 3K5 and mechanical 3M2 (according to EN 50491-2)
- Pollution degree 2 (according to IEC 60664-1)
- Installation on 35 mm rail (according to EN 60715)
- 4 modular units (1 MU = 18 mm)
- IP20 protection degree (installed device)
- Weight 315 g

Technical data

Power supply

- Voltage auxiliary 100-230 Vac 50/60 Hz
- Voltage control section 30 Vdc by KNX bus
- Current consumption from bus < 10 mA
- Power on bus < 240 mW

Outputs

- Number: 8 or 4 independent channels (depending on device use)
- Nominal voltage (U_n): 100-230 Vac 50/60Hz
- Nominal current (I_n): max 16 (10) A (both @100Vac and @230Vac)
- Max. switched power: max 4000 VA @250Vac

Delivery

Delivery includes a terminal block for connection to the bus.

Dimensions [mm]

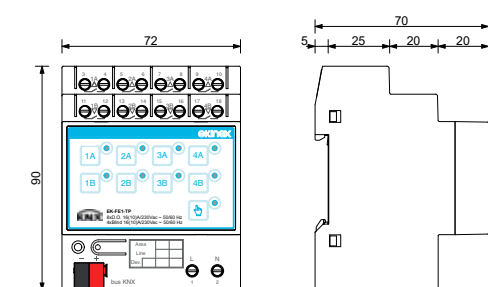

Order information

Code	Package
EK-FE1-TP	1 pcs.



Configuration and commissioning

By means of ETS5 software or later versions
Application program **APEKFE1TP##.knxprod**
(download from www.ekinex.com)



Documentation

For more information see the technical documentation, download from www.ekinex.com



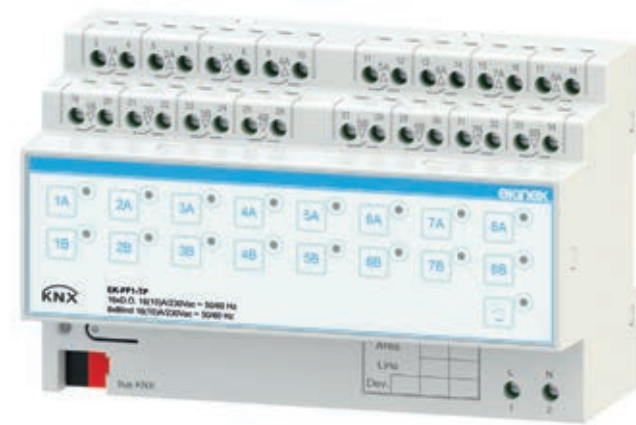

16-fold binary output/ 8-fold blind actuator

ACTUATORS

Description

The Ekinex® EK-FF1-TP binary output / blind actuator allows to command 16 groups of loads or control 8 drives for motorised blinds independently. The device is fitted with membrane pushbuttons for manual command (even in the absence of bus power) and LED's for status indication: a pushbutton allows to switch between automatic and manual operation modes. The device integrates a KNX bus communication module and is realized for mounting on a standard 35 mm DIN-rail. The device is supplied by the KNX bus and requires an additional 230 Vac power supply to operate.

Main features

- Plastic casing
- Frontal programming pushbutton and LED
- Membrane keyboard with LED's for status indication
- Pushbutton for switching operating mode (normal / programming)
- Connection to bus line with KNX terminal block
- Connection of outputs and 230 Vac power supply with screw terminals
- Overvoltage class III (according to EN 60664-1)
- Classification climatic 3K5 and mechanical 3M2 (according to EN 50491-2)
- Pollution degree 2 (according to IEC 60664-1)
- Installation on 35 mm rail (according to EN 60715)
- 8 modular units (1 MU = 18 mm)
- IP20 protection degree (installed device)
- Weight 595 g

Technical data

Power supply

- Voltage auxiliary 100-230 Vac 50/60 Hz
- Voltage control section 30 Vdc by KNX bus
- Current consumption from bus < 10 mA
- Power on bus < 240 mW

Outputs

- Number: 16 or 8 independent channels (depending on device use)
- Nominal voltage (U_n): 100-230 Vac 50/60Hz
- Nominal current (I_n): max 16 (10) A (both @100Vac and @230Vac)
- Max. switched power: max 4000 VA @250Vac

Delivery

Delivery includes a terminal block for connection to the bus.

Dimensions [mm]

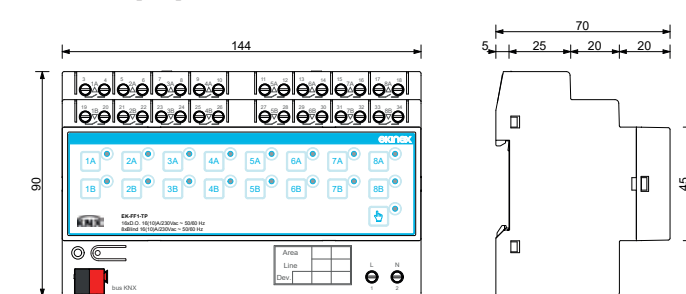

I/O modules

DIN-RAIL MOUNT MODULES

EK-HU1-TP
Input/output module
for office applications

EK-HO1-TP
Input/output module
for hotel applications



30 Vdc power supply from bus	•	•
Auxiliary power supply 230 Vac 50/60 Hz	•	•
Analogue Inputs	1	1
Freely programmable inputs as analogue or binary inputs	1	1
Binary inputs	3	9
Relay outputs 5 (3) A	2	4
Relay outputs 5 (3) A, for fan control	3	3
Relay outputs 16 (10) A, for heating and cooling valve control	-	2
Relay outputs for electric lock control	1	1
Relay outputs 16 (10) A	-	6
0-10 Vdc output	1	1
Membrane keypad for manual control of outputs	•	•
Function for ON/OFF lighting control	1	6
Function for roller shutters / awnings control	1	2
Function for electric strike control	-	•
Temperature control function	•	•
Switch-off scenarios and courtesy lights function	-	•
Logical functions	•	•

Order information

Code	Package
EK-FF1-TP	1 pcs.



Configuration and commissioning

By means of ETS5 software or later versions
Application program **APEKFF1TP##.knxprod**
(download from www.ekinex.com)



Documentation

For more information see the technical documentation,
download from www.ekinex.com



Input/output module for office applications

I/O MODULES



Description

The Ekinex® EK-HU1-TP module allows to manage all functions of an office or a open-space zone: lighting, temperature control, shades and input/output indications. The device is equipped with membrane keys for manual control and status indication LEDs; a pushbutton allows to switch mode from automatic to manual and vice versa. The device integrates a KNX bus communication module and is intended for mounting on a 35 mm standard DIN-rail. It is supplied by the KNX bus; in order to be operational it also requires a 230 Vac voltage.

Main features

- Plastic casing
- Frontal programming pushbutton and LED
- Membrane keypad with LED indication of the input status
- Pushbutton for automatic/manual mode switch
- Connection to bus line with KNX terminal block
- Screw terminal blocks for connecting inputs, outputs and 230 Vac power supply
- 3K5 climatic and 3M2 mechanic classification (according to EN 50491-2)
- Overvoltage class III (according to EN 60664-1)
- Pollution level 2 (according to IEC 60664-1)
- Mounting on 35 mm standard DIN-rail (according to EN 60715)
- 8 modular units (1 UM = 18 mm)
- Protection degree IP20 (device installed)
- Weight 595 g

Technical data

Power supply

- Load power supply 230 Vac 50/60 Hz; electrical lock 12-24 V
- Power supply (electronics) 30 Vdc via KNX bus
- Current consumption by bus < 10 mA
- Power on bus < 240 mW

Order information

Code	Package
EK-HU1-TP	1 pcs.

Inputs

- 1 analogue for NTC temperature sensor (thermostat function)
- 4 digital

Outputs

- 10 digital of which:
 - 3 general purpose
 - 2 (paired) for blind or shade control
 - 5 fancoil: 3 for fan speed (3 speeds) and 2 for controlling electrothermal actuators on hot/cold valves
- 1 analogue 0-10V for fan speed control

Delivery

Delivery includes a terminal block for connection to the bus.

Dimensions [mm]

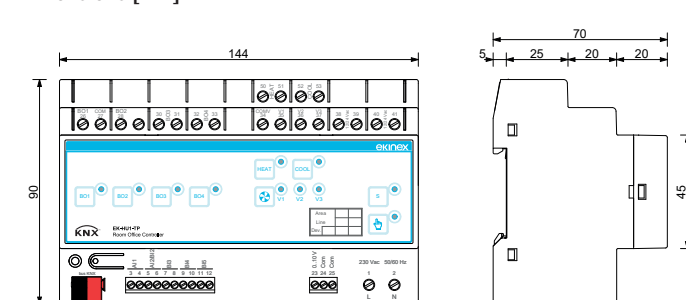

Configuration and commissioning

By means of ETS5 software or later versions
Application program: **APEKHU1TP##.knxprod**
(## = version, downloadable from www.ekinex.com)



Documentation

For more information see the technical documentation, download from www.ekinex.com



Input/output module for hotel applications

I/O MODULES

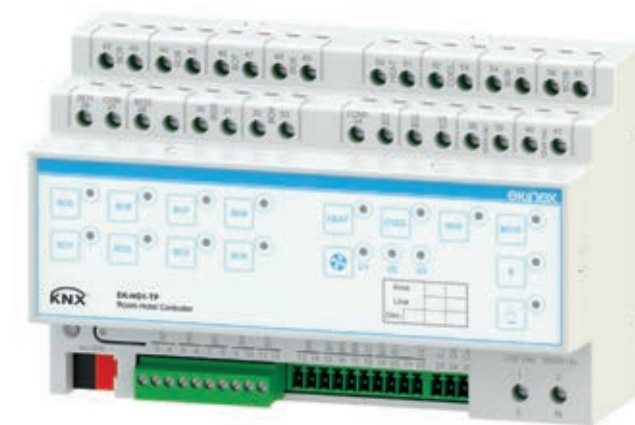

Description

The Ekinex® EK-HO1-TP module allows to manage all functions of a hotel room: lighting, temperature control, shades and input/output indications. The device is equipped with membrane keys for manual control and status indication LEDs; a pushbutton allows to switch mode from automatic to manual and vice versa. The device integrates a KNX bus communication module and is intended for mounting on a 35 mm standard DIN-rail. It is supplied by the KNX bus; in order to be operational it also requires a 230 Vac voltage.

Main features

- Plastic casing
- Frontal programming pushbutton and LED
- Membrane keypad with LED indication of the input status
- Pushbutton for automatic/manual mode switch
- Connection to bus line with KNX terminal block
- Screw terminal blocks for connecting inputs, outputs and 230 Vac power supply
- 3K5 climatic and 3M2 mechanic classification (according to EN 50491-2)
- Overvoltage class III (according to EN 60664-1)
- Pollution level 2 (according to IEC 60664-1)
- Mounting on 35 mm standard DIN-rail (according to EN 60715)
- 8 modular units (1 UM = 18 mm)
- Protection degree IP20 (device installed)
- Weight 595 g

Technical data

Power supply

- Load power supply 230 Vac 50/60 Hz; electrical lock 12-24 V
- Power supply (electronics) 30 Vdc via KNX bus
- Current consumption by bus < 10 mA
- Power on bus < 240 mW

Order information

Code	Package
EK-HO1-TP	1 pcs.

Inputs

- 1 analogue for NTC temperature sensor (thermostat function)
- 1 configurable as analogue or digital
- 10 digital of which:
 - 4 general purpose
 - 2 door or window opening contact
 - 1 pushbutton with pulling call for assistance/emergency
 - 1 badge contact
 - 2 pushbuttons «Do not disturb» e «Please make room»

Outputs

- 15 digital of which:
 - 3 general purpose
 - 3 for indications: «guest in the room», «room assigned», busy room or emergency»
 - 2 (paired) for blind or shade control
 - 1 for courtesy light control
 - 5 for fancoil: 3 for fan speed (3 speeds) and 2 for controlling electrothermal actuators on hot/cold valves
 - 1 digital room contactor and auxiliaries
- 1 powered at 12/24 Vac for controlling an electric lock
- 1 analogue 0-10 V for fan speed control

Delivery

Delivery includes a terminal block for connection to the bus.

Dimensions [mm]

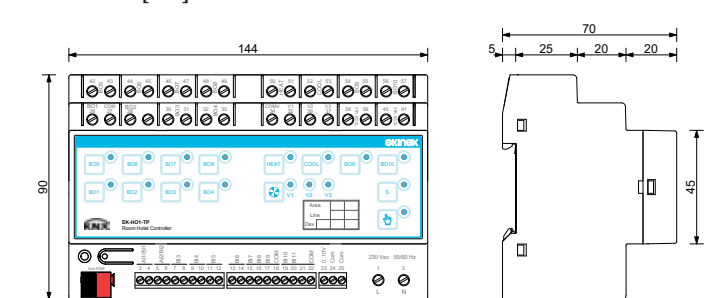

Configuration and commissioning

By means of ETS5 software or later versions
Application program: **APEKHO1TP##.knxprod**
(## = version, downloadable from www.ekinex.com)



Documentation

For more information see the technical documentation, download from www.ekinex.com



Dimmers

DIN-RAIL MOUNT MODULES

EK-GD2-TP-1-HV
KNX Dimmer
90-230V-50/60Hz

EK-GD1-TP-4-HV
KNX Dimmer
90-230V-50/60Hz 4-channels

EK-GC1-TP
4-fold RGBW LED
dimmer

EK-GF1-TP
4-fold 0-10 V
actuator



ON/OFF switching of single or groups of lighting device	•	•	•	•
Brightness regulation and adjusting the light intensity	•	•	•	•
Logical gates and forced mode for each channel	•	•	•	•
Manual control by membrane pushbuttons	-	(1)	•	•
Status feedback of output channels through LEDs	(1)	(1)	•	•
Block function for each channel	•	•	•	•
Without auxiliary power supply	•	•	•	•
Time scheduling: switching delay for on and off, staircase lighting function	•	•	•	•
Integration in scenarios	•	•	•	•
Operating hours counter configurable via bus	•	•	•	•
Fade adjustable ramps	•	•	•	•
RGB / HSV operating mode	-	-	•	•
Mounting on standard 35 mm rail (EN 60715)	(2)	•	•	•

(1) Only for load tests / (2) With appropriate accessory



Description

KNX bus device with single-channel phase cut dimmer function for light loads, with supply voltage 90-230 Vac at 50/60 Hz. Use in KNX standard home and building automation systems.

Main features

- Operating temperature: -20 °C ... + 40 °C
- Storage temperature: 40 °C ... + 60 °C
- Transport temperature: 40 °C ... + 60 °C
- Max. rated casing temperature (tc): 80 °C
- Relative humidity: 91% non-condensing
- Degree of protection: IP00
- Power and load wiring: 1.5 mm² (single cable) 2.5 mm² (stranded cable), 16 to 13 AWG
- Max. torque 0.5 Nm for screw terminals
- KNX bus wiring: 0.26 to 0.5 mm² - 23 to 20 AWG
- Peeling: 5.0 6.0 mm / Plastic casing
- Luminaire for flush-mounting or panel mounting (with supplied accessory)
- Weight: 37 g / Dimensions (LxHxW): 53 x 61 x 29 mm

Functions

- ON/OFF control and dimming of individual or grouped luminaires
- Fade time on and off, minimum and maximum brightness level, linear or logarithmic dimming curve settable from ETS
- Soft or instantaneous switching on and off, with settable delay
- Configuration of behaviour after power reset, bus ON/OFF, unloading via ETS
- Channels can be set by the ETS as independent, in parallel or with copy function from another channel
- Locking function, forced operation, staircase light, scenes, night, counter and logic functions for each channel, settable via ETS
- Alarm for short circuit, open load and power failure
- Auxiliary output function with status indication via KNX
- Manual operation with membrane buttons and for local ON/OFF testing of channels 1-2-3-4 also in the absence of the KNX bus: short press of the button switches the load on/off, pressing for at least 2 seconds makes the load flash every 1 s approx.

Order information

Code	Channels	Packaging
EK-GD2-TP-1-HV	1	1 pcs.

Documentation

For more information see the technical documentation, download from www.ekinex.com



KNX Dimmer 90-230V~50/60Hz

DIMMER

Technical data

Inputs

- Supply voltage: 90 - 230 Vac 50/60 Hz
- Max. input current: 1 A

Outputs

- Supply voltage: 90 - 230 Vac 50/60 Hz
- Output power: 110 W @110 Vac, 220 W @220 Vac, 230 W @230 Vac
- Minimum load power: 1 W
- Max. output current: 1 A

Dimming

- Trailing edge dimming mode with open load control (OPEN CIRCUIT) and short circuit on load (SHORT CIRCUIT)
- Dimming range: 1-100%.

Notes

Loads that can be used with the dimmer can be: incandescent lamps, mains voltage halogen lamps, mains voltage dimmable LED lamps, mains voltage dimmable LED strips, switching power supplies for dimmable LEDs in phase cut. The dimmer cuts phase in trailing edge mode.

Dimensions [mm]

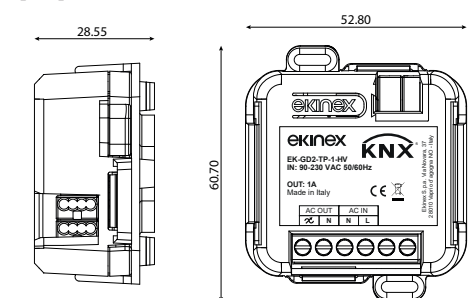

Configuration and commissioning

By means of ETS5 software or later versions
Application program **APEKGD2TP1HV##.knxprod**
(download from www.ekinex.com)





KNX Dimmer 90-230V~50/60Hz 4-channels

DIMMER

Description

KNX bus device with 4-channel phase cut dimmer function for light loads, with supply voltage 90 230 Vac at 50/60 Hz. Use in KNX standard home and building automation systems.

Main features

- Operating temperature: 20 °C ... + 40 °C
- Storage temperature: 40 °C ... + 60 °C
- Transport temperature: 40 °C ... + 60 °C
- Max. rated casing temperature (tc): 80 °C
- Relative humidity: 91% non-condensing
- Degree of protection: IP00 (IP20 in junction box or switch cabinet)
- Power and load wiring: 1.5 mm2 (single cable) 2.5 mm2 (stranded cable), 16 to 13 AWG
- KNX bus wiring: 0.26 to 0.5 mm2 - 23 to 20 AWG
- Peeling: 5.0 6.0 mm
- Plastic casing
- 4 UM panel-mounted luminaire
- Weight: 200 g
- Dimensions (LxHxW): 71 x 91 x 62 mm

Functionality

- ON/OFF control and dimming of individual or grouped luminaires
- Fade time on and off, minimum and maximum brightness level, linear or logarithmic dimming curve settable via ETS
- Soft or instantaneous switching on and off, with settable delay
- Configuration of behaviour after power reset, bus ON/OFF, unloading via ETS
- Channels can be set by the ETS as independent, in parallel or with copy function from another channel
- Status indication of outputs via LEDs
- Locking function, forced operation, staircase light, scenes, night, counter and logic functions for each channel, settable via ETS
- Alarm for short circuit, open load and power failure

Order information

Code	Package
EK-GD1-TP-4-HV	1 pcs.

- Auxiliary output function with status indication via KNX
- Manual operation with membrane buttons and for local ON/OFF testing of channels 1234 even in the absence of the KNX bus: short press of the button switches the load on/off, pressing for at least 2 seconds causes the load to flash every 1 s approx.

Technical data

Inputs

- Supply voltage: 90 230 Vac 50/60 Hz
- Max. input current: 4 A

Outputs

- Supply voltage: 90 230 Vac 50/60 Hz
- Output power per channel: 110 W @110 Vac, 220 W @220 Vac, 230 W @230 Vac
- Minimum load power: 1 W per channel
- Max. output current: 1 A per channel

Dimming

- Trailing edge dimming mode with open load control (OPEN CIRCUIT) and short circuit on load (SHORT CIRCUIT)
- Dimming range: 1100%.

Note

Loads that can be used with the dimmer can be: incandescent lamps, mains voltage halogen lamps, mains voltage dimmable LED lamps, mains voltage dimmable LED strips, switching power supplies for dimmable LEDs in phase cut. The dimmer cuts phase in trailing edge mode.

Dimensions [mm]

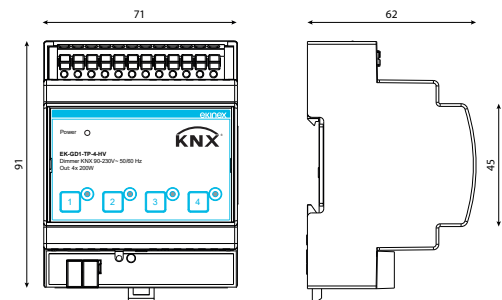

4-fold RGBW LED dimmer

DIMMERS

Description

The Ekinex® EK-GC1-TP 4-fold RGBW LED dimmer allows to regulate independently the light intensity emitted by 4 LED strips at 12/24 Vdc or, alternatively, to regulate the light intensity and the colour emitted by a RGB or RGBW LED strip. The device is suitable for use with LED strips powered at constant voltage. The selection of the colour can be made optionally in HSV or RGB mode. Scenarios, predefined sequences, sequence repetition and random functions are available; the dimming speed and the holding time are programmable. The device is fitted with membrane pushbuttons for manual command and LEDs for status indication; a pushbutton allows the switching between automatic or manual operation modes. The device integrates a KNX bus communication module and is realised for mounting on a standard 35 mm DIN-rail. The device is powered by the KNX bus and requires an additional 12...30 Vdc to supply the controlled loads.

Main features

- Plastic casing
- Frontal programming pushbutton and LED
- Membrane keyboard with LEDs for status indication of outputs
- Pushbutton for switching operating mode (normal / programming)
- CH pushbutton for individual or simultaneous channels control
- HSV / RGB pushbutton colour control mode
- Auxiliary dry contact to disconnect load power supply during standby
- Connection to bus line with KNX terminal block
- Connection of outputs and 12-30 Vdc power supply with screw terminals
- Installation on 35 mm rail (according to EN 60715)
- 4 modular units (1 MU = 18 mm)
- IP20 protection degree (installed device)

Technical data

Power supply

- Voltage (strip LED): max 30 Vdc, 16 A
- Voltage (control): 30 Vdc by KNX bus

Outputs

- Number: 4
- Load current for each channel: 4 A

Delivery

Delivery includes a terminal block for connection to the bus.

Dimensions [mm]

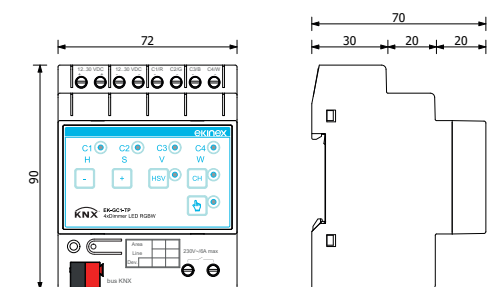

Order information

Code	Package
EK-GC1-TP	1 pcs.



Configuration and commissioning

By means of ETS5 software or later versions
Application program **APEKGC1TP##.knxprod**
(download from www.ekinex.com)



Documentation

For more information see the technical documentation,
download from www.ekinex.com



Configuration and commissioning

By means of ETS5 software or later versions
Application program **APEKGD1TP4HV##.knxprod**
(download from www.ekinex.com)



Documentation

For more information see the technical documentation,
download from www.ekinex.com





4-fold 0-10 V actuator

DIMMERS

Description

The Ekinex® 4-fold 0-10 V actuator EK-GF1-TP can be used as 0-10 V control output device or, alternatively, for controlling dimmable LED power supply units. When used for LED controlling, the selection of the colour can be made optionally in HSV or RGB mode. Scenarios, predefined sequences, sequence repetition and random functions are available; the dimming speed and the holding time are programmable. The device is fitted with membrane pushbuttons for manual command and LEDs for status indication; a pushbutton allows the switching between automatic or manual operation modes. The device integrates a KNX bus communication module and is realised for mounting on a standard 35 mm DIN-rail. The device is powered by the KNX bus.

Main features

- Plastic casing
- Frontal programming pushbutton and LED
- Membrane keyboard with LEDs for status indication of outputs
- Pushbutton for switching operating mode (normal / programming)
- CH pushbutton for individual or simultaneous channels control
- HSV / RGB pushbutton colour control mode
- Connection to bus line with KNX terminal block
- Connection of outputs with screw terminals
- Installation on 35 mm rail (according to EN 60715)
- 4 modular units (1 MU = 18 mm)
- IP20 protection degree (installed device)

Technical data

Power supply

- Voltage (control): 30 Vdc by KNX bus
- Rated output stage supply voltage: 100-230Vac, 50/60Hz max 5W

Outputs

- Number: 4
- Range: 0-10 V or 1-10V
- Max. current for each channel: 50 mA

Delivery

Delivery includes a terminal block for connection to the bus and a terminal block for connection to the auxiliary power supply.

Dimensions [mm]

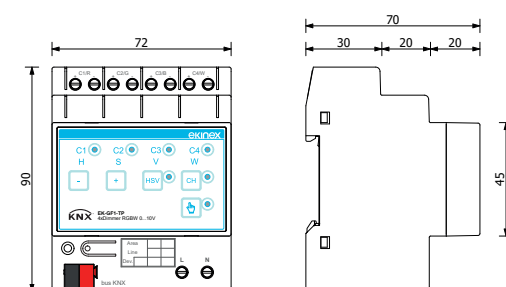

Order information

Code	Package
EK-GF1-TP	1 pcs.



Configuration and commissioning

By means of ETS5 software or later versions
Application program **APEKGF1TP##.knxprod**
(download from www.ekinex.com)



Documentation

For more information see the technical documentation,
download from www.ekinex.com



Dimmer 90-230V~ 50/60Hz

DIMMERS

Description

The single-channel phase cut dimmer EK-GD2-1-HV allows the brightness control of LED and halogen sources with a voltage of 90-230 Vac 50/60Hz for up to 220W.

Main features

- Plastic housing
- Device for free installation in junction boxes or wall
- Mounting on 35 mm profile rail (by means of code holder included)
- IP10 degree of protection (device installed)

Functions

- Dimming up to complete switch-off (dim-to-dark)
- Minimum brightness level: 1%
- Optimised output curve

Connections

- Screw terminals for control, supply and loads

Technical data

- Single-channel dimmer with phase-cut output
- Supply range: 90-230 Vac 50/60Hz
- Maximum output power 230W
- Control inputs: non-isolated N.O. pushbutton
- Maximum resistive load 1A.
- Conductor diameter 12-30 AWG (0.05-2.5 mmq)
- Storage temperature Min: -40°C Max: 60°C

Note

For electronic loads and/or LEDs consider maximum power halved from nominal value.

Dimensions [mm]

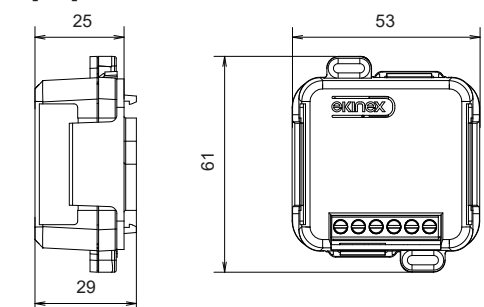

Order information

Code	Channels	Packaging
EK-GD2-1-HV	1	1 pcs.



Documentation

For more information see the technical documentation,
download from www.ekinex.com



DALI Dimmers

DIN RAIL MOUNT MODULES

- EK-GD2-DL-1-LV
DALI Dimmer
12 / 48 Vdc
- EK-GD2-DL-2-LV
DALI Dimmer
12 / 48 Vdc 2 channels
- EK-GD2-DL-1-HV
Dali Dimmer
90-230V-50/60Hz
- EK-GD1-DL-4-LV
Dali Dimmer
12/48V dc 4 channels
- EK-GD1-DL-4-HV
Dali Dimmer
90-230V-50/60Hz
4 channels



Memory function	•	•	•	•	•
Brightness adjustment until complete switch-off	•	•	•	•	•
Local control input	•	-	-	-	-
PWM modulation with settable frequency (300 / 600 / 1200 Hz)	-	-	-	•	-
Settable dimming curve: linear / logarithmic	•	•	•	•	•
Smooth switching on and off	•	•	•	•	•
Optimised output curve	•	•	•	•	•
Screw terminals for DALI bus, control, power supply and LED source	•	•	•	•	•
Device power supply: 10.8 Vdc (min)... 52.8 Vdc (max)	•	•	-	•	-
Device power supply: 90-230 Vac 50/60 Hz	-	-	•	-	•



Description

The DALI-2 1-channel dimmer EK-GD2-DL-1-LV allows the brightness control of low voltage LED sources from 12 to 48Vdc by means of PWM dimming. DALI-2 bus input reference IEC 62386. The 2-channel DALI-2 dimmer EK-GD2-DL-2-LV allows the control of brightness and colour temperature of low-voltage LED sources from 12 to 48Vdc by means of PWM dimming. Dynamic white temperature control TW DALI DT8, 2 independent channels (2 DALI addresses) or a single DALI DT6 channel. Functions can be set by means of a selector switch. Bus input DALI-2 reference IEC 62386.

Main features

- Plastic housing
- Free-standing device for installation in junction boxes or walls
- Mounting on 35 mm profile rail (using special bracket code included)
- IP10 degree of protection (device installed)

Functions

- Memory function settable by DALI
- Dimming up to complete switch-off (dim-to-dark)
- Minimum brightness level: 0.1%
- PWM modulation flicker free (2000 Hz)
- DALI-settable dimming curve: linear or logarithmic
- Switch-on and switch-off times settable by DALI
- Optimised output curve

Order information

Code	Channels	Packaging
EK-GD2-DL-1-LV	1	1 pcs.
EK-GD2-DL-2-LV	2	

DALI Dimmer 12/48 Vdc

DALI DIMMERS



Connections

- Screw terminals for DALI bus, control, power supply and LED source
- Max. connection length between dimmer-driver and control < 10 m

Technical data

- Device power supply: 10.8 Vdc (min)... 52.8 Vdc (max)
- Max. power: 240W
- Control: BUS DALI or local button

Dimensions [mm]

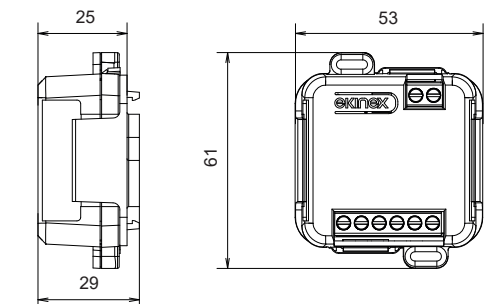

Documentation

For more information see the technical documentation, download from www.ekinex.com



1 CHANNEL 2 CHANNELS



DALI Dimmer 90-230V~ 50/60Hz

DALI DIMMERS



Description

The single-channel phase cut dimmer EK-GD2-DL-1-HV allows the brightness control of LED and halogen sources with a voltage of 90-230 Vac 50/60Hz for up to 220Watts. Input Bus DALI-2 reference IEC 62386 standard.

Main features

- Plastic housing
- Device for free installation in junction boxes or wall
- Mounting on 35 mm profile rail (by means of code holder included)
- IP10 degree of protection (device installed)

Functions

- Dimming up to complete switch-off (dim-to-dark)
- Minimum brightness level: 1%
- Optimised output curve

Connections

- Screw terminals for DALI bus, control, power supply and LED source

Technical data

- Single-channel dimmer with phase-cut output
- Supply range: 90-230 Vac 50/60Hz
- Maximum output power 230W
- Control inputs: DALI bus
- Maximum resistive load 1A.
- For electronic and/or LED loads the power is halved
- Conductor diameter 12-30 AWG (0.05-2.5 mmq)
- Storage temperature Min: -40°C Max: 60°C

Note

For electronic loads and/or electronic LEDs consider maximum power halved from nominal value.

Dimensions [mm]

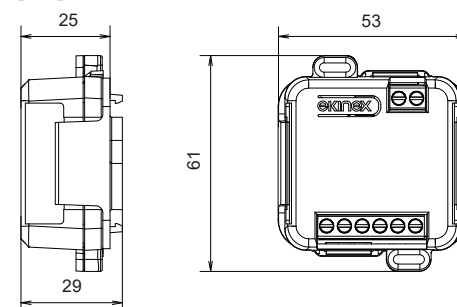

DALI Dimmer 12/48Vdc 4 channels

DALI DIMMERS



Description

The 4-channel DALI-2 dimmer allows control of brightness, temperature and RGBW colour of low-voltage LED sources. Power supply from 12 to 48Vdc, PWM dimming. Compliant with the new FLICKER-FREE standard. Input Bus DALI-2 reference IEC 62386 standard.

Main features

- Plastic housing
- Device with 4 modular units
- IP20 degree of protection (device installed)

Functions

- Memory function
- Brightness adjustment until complete switch-off (dim-to-dark)
- Minimum brightness level: 0.1% (1% in push)
- PWM modulation with settable frequency (300/600/1200/2000Hz)
- Settable dimming curve: linear / quadratic / exponential
- Smooth switching on and off
- Optimised output curve

Connections

- Dip-switch for setting operating mode, frequency dimming connections
- Spring terminals for easy application

Technical data

- Device power supply: 10.8 Vdc (min)... 52.8 Vdc (max)
- Power consumption (at 40°C): 480 Watts total
- Dali absorption 1.53mA

Dimensions [mm]

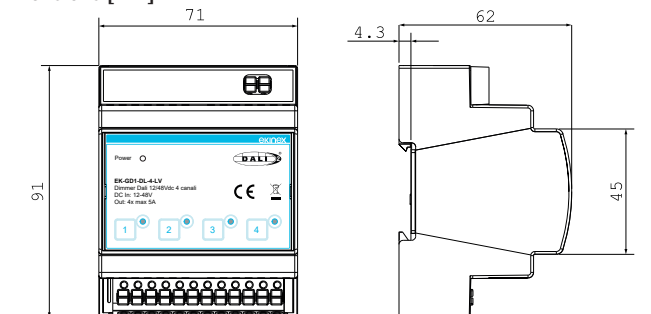

Order information

Code	Channels	Packaging
EK-GD2-DL-1-HV	1	1 pcs.



Documentation

For more information see the technical documentation, download from www.ekinex.com



Order information

Code	Channels	Packaging
EK-GD1-DL-4-LV	4	1 pcs.



Documentation

For more information see the technical documentation, download from www.ekinex.com





DALI Dimmer 90-230V~ 50/60Hz 4 channels

DALI DIMMERS



Description

The 4-channel DALI-2 dimmer allows brightness control of LED and halogen sources with voltage 90-230 Vac 50/60Hz for up to 200Watts on 4 channels each. Input Bus DALI-2 reference IEC 62386 standard.

Main features

- Plastic housing
- Device with 4 modular units
- Mounting on 35 mm profile rail (according to EN 60715)
- IP20 degree of protection (device installed)

Functions

- Memory function, fade time, minimum and maximum level settable via DALI software
- Dimming up to complete switch-off (dim-to-dark)
- Minimum brightness level: 0.1%
- Dimming curve: linear / logarithmic settable by DALI
- Electronic short-circuit and overload protection

Connections

Spring terminals for easy application

Technical data

- 4-channel dimmer with phase cut output
- Power supply range: 90-230 Vac 50/60Hz
- Maximum power output 200W per channel
- For electronic loads and/or electronic LEDs the power is halved
- Conductor diameter 12-30 AWG (0.05-2.5 mmq)
- Storage temperature Min: -40°C Max: 60°C

Note

For electronic loads and/or electronic LEDs consider maximum power halved from nominal value.

Dimensions [mm]

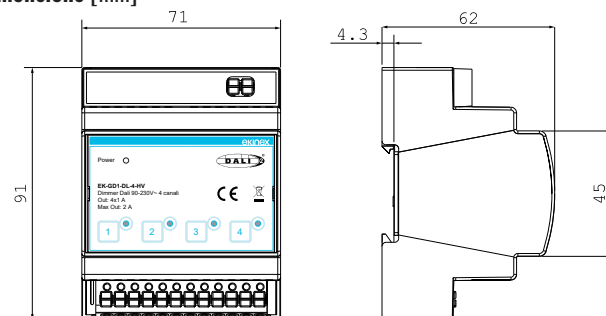

Order information

Code	Channels	Packaging
EK-GD1-DL-4-HV	4	1 pcs.



Documentation

For more information see the technical documentation, download from www.ekinex.com



Thermoregulation

DIN-RAIL MOUNT MODULES

- EK-HA1-TP Fan-coil actuator / controller 3-speed fan control
- EK-HB1-TP Fan-coil actuator / controller 0-10 V fan control
- EK-HC1-TP Fan-coil actuator / controller full version
- EK-HE1-TP 8-fold actuator / controller for electrothermal valve drives
- EK-HH1-TP Mixing actuator



Power 30 Vdc from KNX bus	•	•	•	•	•
Auxiliary power supply 230 Vac 50/60 Hz	•	•	•	•	•
Analogue input (passive temperature sensors 10 kΩ NTC at 25°C)	•	•	•	-	•
Digital input (potential-free)	•	•	•	-	•
Output relays	•	•	•	-	•
Output triac relays	-	-	-	•	•
Output 0-10V (high impedance signal control)	-	•	•	-	•
Membrane keyboard for manual/automatic control with status indication LEDs	-	-	•	-	•
LCD-display	-	-	-	-	•
2-pipe hydraulic distribution systems applications	•	•	•	•	-
4-pipe hydraulic distribution systems applications	-	-	•	•	-
Actuator	•	•	•	•	-
Internal controller	•	•	•	•	•
Air flow terminal: ventilation	•	•	•	-	-
Air flow terminal: convector	•	•	•	-	-
Air flow terminal: fan-coil	•	•	•	-	-
Air flow terminal: fan-coil + 2° electrical stage	-	-	•	-	-
Underfloor and ceiling systems distribution	-	-	-	-	•
Underfloor and ceiling mixing valve systems	-	-	-	-	•
Mounting on standard 35 mm rail (EN 60715)	•	•	•	•	•

EK-B01-TP-RMA
Modbus / KNX interface for RDZ air handling units



Power 30 Vdc from KNX bus	•
Mounting on standard 35 mm rail (EN 60715)	•
Supported RDZ air handling units	
Mechanical ventilation with heat recovery	CHR Family WHR Family
Air renewal with dehumidification	UAP PDC Family UC Family
LED signalling Modbus traffic	•
Device status LED	•
LED error indication	•
KNX programming LED	•
Programming button	•



Fancoil actuator / controller 3-speed fan control

THERMOREGULATION

Description

The Ekinex® EK-HA1-TP fancoil actuator / controller allows to control a fan coil unit for the air conditioning of a room. The device can perform the function of simple actuator in combination with a KNX room thermostat or that of actuator / controller with acquisition of the temperature value by a KNX room sensor or a probe connected to an analogue input. The device is suitable for 2-pipe hydraulic distribution systems with ON / OFF control of one electrothermal shut-off valve actuator and a 3-speed fan. The outputs not used to control the fan coil unit can be configured as binary output channels for different functions. The device is equipped with 2 inputs freely configurable as analogue or digital. The device integrates a KNX bus communication module and is realized for mounting on a standard 35 mm DIN-rail. The device is supplied by the KNX bus and requires an additional 230 Vac power supply to operate.

Main features

- Plastic casing
- Frontal programming pushbutton and LED
- Connection to bus line with KNX terminal block
- Connection of inputs, outputs and 230 Vac power supply with screw terminals
- Classification climatic 3K5 and mechanical 3M2 (according to EN 50491-2)
- Overvoltage class III (according to EN 60664-1)
- Pollution degree 2 (according to IEC 60664-1)
- 35 mm rail mounting (according to EN 60715)
- 4 modular units (1 MU = 18 mm)
- IP20 protection degree (installed device)
- Weight 175 g

Technical data

Power supply

- Voltage (loads) 230 Vac 50/60 Hz
- Voltage (electronics) 30 Vdc by KNX bus

Inputs

- 2 freely configurable for passive temperature sensors (10 kΩ NTC at 25°C) or as potential-free binary inputs

Outputs

- 3 interlocked relay outputs to control a 3-speed fan (or configurable as binary outputs for different applications)
- 1 relay SPST (single pole, single throw) to control an ON / OFF valve (in 2-pipe hydraulic distribution systems)

Delivery

Delivery includes a terminal block for connection to the bus.

Dimensions [mm]

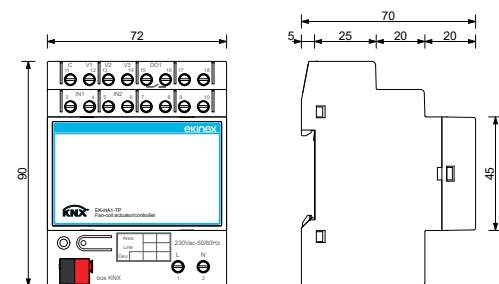

Order information

Code	Package
EK-HA1-TP	1 pcs.



Configuration and commissioning

By means of ETSS software or later versions
Application program **APEKHA1TP##.knxprod**
(download from www.ekinex.com)



Documentation

For more information see the technical documentation,
download from www.ekinex.com



Fancoil actuator / controller 0-10 V fan control

THERMOREGULATION

Description

The Ekinex® EK-HB1-TP fancoil actuator / controller allows to control a fan coil unit for the air conditioning of a room. The device can perform the function of simple actuator in combination with a KNX room thermostat or that of actuator / controller with acquisition of the temperature value by a KNX room sensor or a probe connected to an analogue input. The device is suitable for 2-pipe hydraulic distribution systems with ON / OFF control of one electrothermal shut-off valve actuator and a fan with brushless motor. The outputs not used to control the fan coil unit can be configured as binary output channels for different functions. The device is equipped with 2 inputs freely configurable as analogue or digital. The device integrates a KNX bus communication module and is realized for mounting on a standard 35 mm DIN-rail. The device is supplied by the KNX bus and requires an additional 230 Vac power supply to operate.

Main features

- Plastic casing
- Frontal programming pushbutton and LED
- Connection to bus line with KNX terminal block
- Connection of inputs, outputs and 230 Vac power supply with screw terminals
- Classification climatic 3K5 and mechanical 3M2 (according to EN 50491-2)
- Overvoltage class III (according to EN 60664-1)
- Pollution degree 2 (according to IEC 60664-1)
- 35 mm rail mounting (according to EN 60715)
- 4 modular units (1 MU = 18 mm)
- IP20 protection degree (installed device)
- Weight 175 g

Technical data

Power supply

- Voltage (loads) 230 Vac 50/60 Hz
- Voltage (electronics) 30 Vdc by KNX bus

Inputs

- 2 freely configurable for passive temperature sensors (10 kΩ NTC at 25°C) or as potential-free binary inputs

Outputs

- 1 to control a brushless motor driven fan with 0-10 V signal
- 1 relay SPST (single pole, single throw) to control an ON / OFF valve (in 2-pipe hydraulic distribution systems)

Delivery

Delivery includes a terminal block for connection to the bus.

Dimensions [mm]

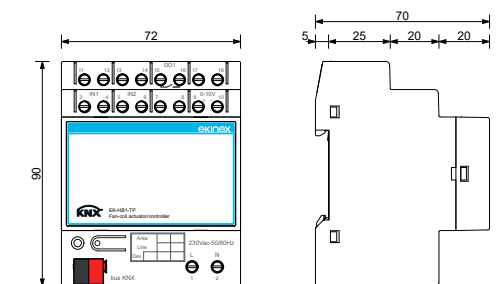

Order information

Code	Package
EK-HB1-TP	1 pcs.



Configuration and commissioning

By means of ETSS software or later versions
Application program **APEKHB1TP##.knxprod**
(download from www.ekinex.com)



Documentation

For more information see the technical documentation,
download from www.ekinex.com





Fancoil actuator / controller full version

THERMOREGULATION

Description

The Ekinex® EK-HC1-TP fancoil actuator / controller allows to control a fan coil unit for the air conditioning of a room. The device can perform the function of simple actuator in combination with a KNX room thermostat or that of actuator / controller with acquisition of the temperature value by a KNX room sensor or a probe connected to an analogue input. The device is suitable for 2 or 4-pipe hydraulic distribution systems with ON / OFF control of one or two electrothermal shut-off valve actuators and a 3-speed fan or a brushless motor driven fan. The outputs not used to control the fan coil unit can be configured as binary output channels for different functions. The device is equipped with 3 inputs freely configurable as analogue or digital. The device is fitted with membrane pushbuttons for manual command and LED's for status indication: a pushbutton allows to switch between automatic and manual operation modes. The device integrates a KNX bus communication module and is realized for mounting on a standard 35 mm DIN-rail. The device is supplied by the KNX bus and requires an additional 230 Vac power supply to operate.

Main features

- Plastic casing
- Frontal programming pushbutton and LED
- Membrane keyboard with LED's for status indication
- Pushbutton for switching operating mode (normal / programming)
- Connection to bus line with KNX terminal block
- Connection of inputs, outputs and 230 Vac power supply with screw terminals
- Classification climatic 3K5 and mechanical 3M2 (according to EN 50491-2)
- Overvoltage class III (according to EN 60664-1)
- Pollution degree 2 (according to IEC 60664-1)
- 35 mm rail mounting (according to EN 60715)
- 4 modular units (1 MU = 18 mm)
- IP20 protection degree (installed device)
- Weight 205 g

Technical data

Power supply

- Voltage (loads) 230 Vac 50/60 Hz
- Voltage (electronics) 30 Vdc by KNX bus

Inputs

- 3 freely configurable for passive temperature sensors (10 kΩ NTC at 25°C) or as potential-free binary inputs

Outputs

- 1 to control a brushless motor driven fan with 0-10 V signal
- 3 interlocked relay outputs to control a 3-speed fan (or configurable as binary outputs for different applications)
- 2 relay SPST (single pole, single throw) to control two ON / OFF valves (in 2 or 4-pipe hydraulic distribution systems)

Delivery

Delivery includes a terminal block for connection to the bus.

Dimensions [mm]

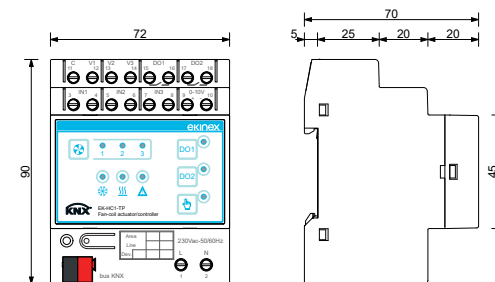

Configuration and commissioning

By means of ETSS software or later versions
Application program **APEKHC1TP##.knxprod**
(download from www.ekinex.com)



Documentation

For more information see the technical documentation,
download from www.ekinex.com



Order information

Code	Package
EK-HC1-TP	1 pcs.



8-fold actuator / controller for electrothermal valve drives

THERMOREGULATION

Description

The Ekinex® EK-HE1-TP actuator / controller allows to control electrothermal actuators or servomotors in hydronic systems for room heating and / or cooling. The device can perform the function of simple actuator in combination with one or more KNX room thermostats or that of actuator / controller with acquisition of the temperature value by one or more KNX sensors. The device is suitable for 2 or 4-pipe hydraulic distribution systems with ON / OFF control of electrothermal shut-off valve actuators. The device is fitted with membrane pushbuttons for manual command and LED's for status indication; a pushbutton allows to switch between automatic and manual operation modes. The device integrates a KNX bus communication module and is realized for mounting on a standard 35 mm DIN-rail. The device is supplied by the KNX bus and requires an additional 230 Vac power supply to operate.

Main features

- Plastic casing
- Frontal programming pushbutton and LED
- Membrane keyboard with LED's for status indication
- Pushbutton for switching operating mode (normal / programming)
- Connection to bus line with KNX terminal block
- Connection of outputs and 230 Vac power supply with screw terminals
- Classification climatic 3K5 and mechanical 3M2 (according to EN 50491-2)
- Overvoltage class III (according to EN 60664-1)
- Pollution degree 2 (according to IEC 60664-1)
- 35 mm rail mounting (according to EN 60715)
- 4 modular units (1 MU = 18 mm)
- IP20 protection degree (installed device)
- Weight 160 g

Technical data

Power supply

- Voltage (loads) 230 Vac 50/60 Hz
- Voltage (electronics) 30 Vdc by KNX bus

Outputs

- 8 TRIAC relays to control ON / OFF zone valve drives

Delivery

Delivery includes a terminal block for connection to the bus.

Dimensions [mm]

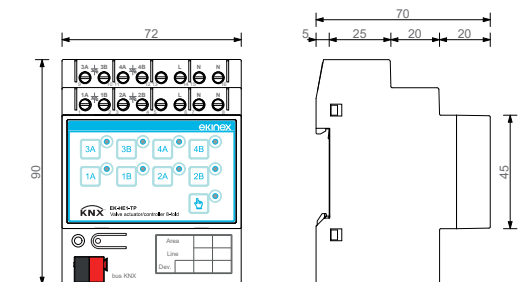

Configuration and commissioning

By means of ETSS software or later versions
Application program **APEKHE1TP##.knxprod**
(download from www.ekinex.com)



Documentation

For more information see the technical documentation,
download from www.ekinex.com



Mixing actuator

THERMOREGULATION



Description

The Ekinex® EK-HH1-TP mixing actuator allows the control of 3 floating points or 0-10 V servo-motor for mixing valves. The flow temperature of the conveying fluid can be set at a fixed point, with external climatic compensation and with external climatic compensation plus internal conditions recalibration. The regulation modes are selectable separately for heating and cooling. The device is particularly suitable for underfloor or ceiling heating and cooling radiant panels applications in combination with Ekinex® room thermostats with integrated temperature and humidity sensor. A 0-10 V output allows the remote setting of a heat pump temperature setpoint value. The start-up function enables a radiant floors drying concrete phase according to EN 1264 standard. The membrane keyboard allows the manual command and includes LED's for status indication; the LCD-display allows displaying / setting of the main working parameters. The device integrates a KNX bus communication module and is realized for mounting on a standard 35 mm DIN-rail. The device is supplied by the KNX bus and requires an additional 230 Vac power supply to operate.

Main features

- Plastic casing
- Frontal programming pushbutton and LED
- Membrane keyboard with LED's for status indication
- Pushbutton for switching operating mode (normal / programming)
- Connection to bus line with KNX terminal block
- Connection of inputs, outputs and 230 Vac power supply with screw terminals
- Classification climatic 3K5 and mechanical 3M2 (according to EN 50491-2)
- Overvoltage class III (according to EN 60664-1)
- Pollution degree 2 (according to IEC 60664-1)
- 35 mm rail mounting (according to EN 60715)
- 8 modular units (1 MU = 18 mm)
- IP20 protection degree (installed device)
- Weight 380 g

Technical data

Power supply

- Voltage (loads) 230 Vac 50/60 Hz
- Voltage (electronics) 30 Vdc by KNX bus

Inputs

- 3 analogical exclusively for connection of NTC temperature sensors 10 kΩ at 25°C
- 2 configurable as analogical (exclusively for NTC temperature sensors 10 kΩ at 25°C) or digital (potential free)

Outputs

- 1 for control of a 3 point floating servomotor, 1 A, 250 Vac
- 1 for control of a servomotor with 0-10 V signal connection of high impedance input
- 3 for additional functions, relays 10(5) A, 250 Vac

Delivery

Delivery includes a terminal block for connection to the bus.

Dimensions [mm]

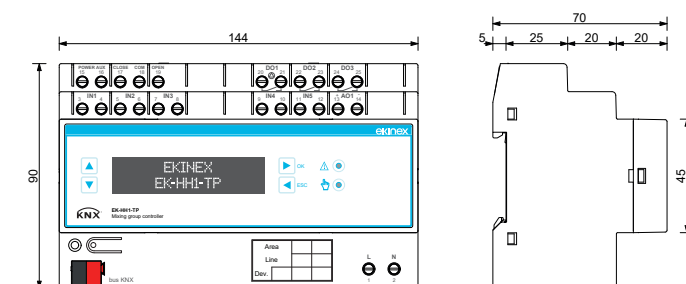

Order information

Code	Package
EK-HH1-TP	1 pcs.



Configuration and commissioning

By means of ETS5 software or later versions
Application program **APEKHH1TP#.#.knxprod**
(download from www.ekinex.com)



Documentation

For more information see the technical documentation,
download from www.ekinex.com



NTC 10 kΩ temperature sensors

TEMPERATURE CONTROL

Description

Temperature sensors with NTC (Negative Temperature Coefficient, 10 kΩ ±1% at 25 °C, B = 3435) sensitive element for temperature measurement, to be used in combination with Ekinex® KNX devices equipped with an analogue input (or configurable as [AI]) for temperature measurement.

Characteristics and Technical data

Outdoor version (EK-STE-10K-3435)

- Sensitive element with high IP protection degree casing
- Cable gland (connecting cable not included in delivery)
- Working conditions:
 - operating temperature: -40°C...+100°C
 - relative humidity: 0...100%

Immersion version (EK-STI-10K-3435)

- Sensitive element with INOX cylinder casing
- Two-wire connecting cable (length 1,5 m)
- Operating temperature: -40°C...+105°C

Contact version (EK-STC-10K-3435)

- Brass toecap
- Two-wire connecting cable (length 1,5 m)
- Operating temperature: -40°C...+100°C

Air mass version (EK-STL-10K-3435)

- Sensor printed directly on the connecting cable
- Two-wire connecting cable (length 1,5 m)
- Operating temperature: -50°C...+105°C

Dimensions [mm]

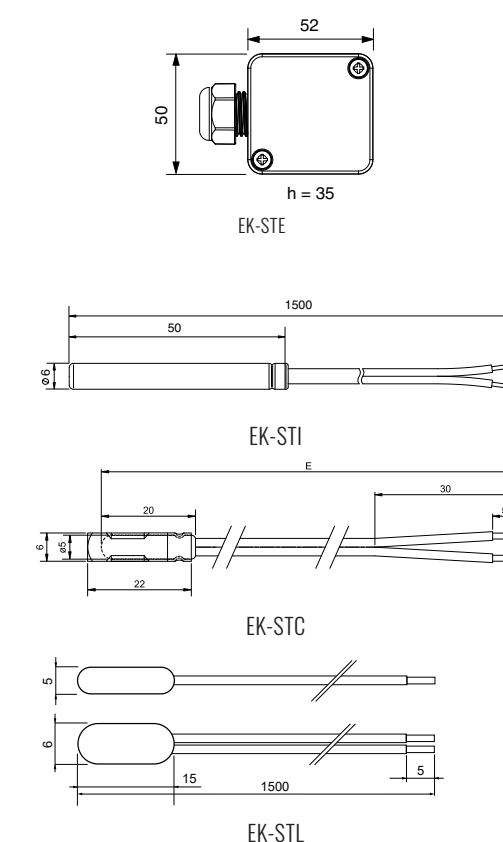

Order information

Code	Version	Package
EK-STE-10K-3435	outdoor	1 pcs.
EK-STI-10K-3435	immersion	
EK-STC-10K-3435	contact	
EK-STL-10K-3435	air mass	



Configuration and commissioning

The configuration is necessary for the Ekinex® KNX device connected to the temperature sensor.



Documentation

For more information see the technical documentation,
download from www.ekinex.com



EK-STE EK-STI EK-STC EK-STL



Modbus / KNX interface for RDZ air handling units

THERMOREGULATION

Description

The Ekinex® EK-B01-TP-RMA interface is a modular KNX S-mode device that allows bidirectional communication between the RDZ air handling units, equipped with control board with RS-485 Modbus communication port, and the KNX system (TP). Thanks to the interface, the functions performed by the air handling units can be controlled and monitored by KNX devices. The unit has an integrated KNX bus communication module and is realized for mounting on a 35 mm rail. Power is supplied via the KNX bus.

Main features

- Plastic housing
- Mounting on 35 mm rail (according to EN 60715)
- Protection degree IP20 (installed device)
- Safety class II
- Weight 70 g
- 2 modular units (1 unit = 18 mm)
- Dimensions 36 x 94 x 71 mm (WxHxD)

Technical data

Power supply

- 30 Vdc voltage by KNX bus
- Current consumption (from main bus line) < 13 mA

Dimensions [mm]

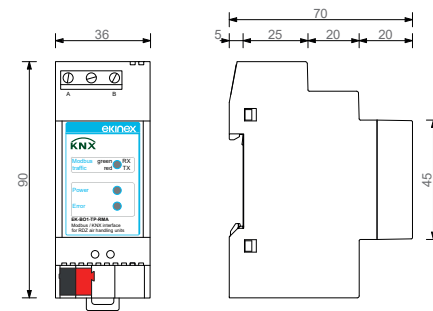

Gateway

DIN-RAIL MOUNT MODULES

EK-BH1-TP-485	EK-BH1-TP-TCP	EK-BJ1-TP-IP	EK-BJ1-TP-MSTP	EK-BK1-TP	EK-BM1-TP-xx	EK-BN1-TP	EK-BG1-TP	EK-BF1-TP-D1	EK-BF1-TP-D2
Gateway Modbus RS485-KNX	Gateway Modbus TCP/IP-KNX	Gateway BACnet IP-KNX	Gateway BACnet MS/TP-KNX	Gateway DMX-KNX	Gateway M-Bus-KNX	Gateway PROFINET-KNX	Gateway DALI-KNX	Gateway DALI-KNX 1 channel	Gateway DALI-KNX 2 channels



Auxiliary power supply	•	•	•	•	•	•	•	-	-
Electrically insulated RS485 serial communication port	•	-	-	•	•	-	-	-	-
1-way DIP switch to activate the line terminator (120 Ohm)	•	-	-	-	•	-	-	-	-
Modbus master RTU (Remote Terminal Unit) communication	•	•	-	-	-	-	-	-	-
BACnet slave communication	-	-	•	-	-	-	-	-	-
BACnet communication	-	-	-	-	-	-	-	-	-
PROFINET slave communication	-	-	-	-	-	•	-	-	-
BACnet records exchange	-	-	•	-	-	-	-	-	-
PROFINET records exchange	-	-	-	-	-	•	-	-	-
DMX master communication	-	-	-	•	-	-	-	-	-
250 kbaud communication speed	-	-	-	•	-	-	-	-	-
From 1200 to 115200 baud communication speed	•	-	•	-	-	-	-	-	-
from 3000 to 38400 baud communication speed	-	-	-	-	•	-	-	-	-
Ethernet (IEEE 802.3) communication port, RJ45 connector	-	•	•	-	-	•	•	-	-
M-Bus communication port	-	-	-	-	•	-	-	-	-
Device addressing from 1 to 250	-	-	-	-	•	-	-	-	-
Device addressing from 0 to 250	•	•	-	-	-	-	-	-	-
Device addressing from 0 to 512	-	-	-	-	•	-	-	-	-
Register exchange of Coil, Input, and Input Register Holding Register type	•	•	-	-	-	-	-	-	-
Reading and writing of single and multiple registers	•	•	-	-	-	-	-	-	-
1 byte register writing on a maximum of 512 DMX devices	-	-	-	•	-	-	-	-	-
Volatile support memory with "image Modbus" of 1440 byte	•	•	-	-	-	-	-	-	-
Volatile support memory with "image BACnet" of 1440 byte	-	-	•	•	-	-	-	-	-
Volatile support memory with "image M-Bus" of 1440 byte	-	-	-	-	•	-	-	-	-
Volatile support memory with "image PROFINET" of 1440 byte	-	-	-	-	-	•	-	-	-
KNX TP (twisted pair) 9600 baud communication port	•	•	•	•	•	•	•	•	-
Volatile support memory with "image KNX" of 1440 byte	•	•	•	•	•	•	•	•	-
Additional plug-in program	•	•	•	•	•	•	•	•	•
Mounting on standard 35 mm rail (EN 60715)	•	•	•	•	•	•	•	•	•
DALI communication protocol	-	-	-	-	-	-	-	•	•
Ballast addressing to 64 devices	-	-	-	-	-	-	-	•	•
Ballast addressing to 128 devices	-	-	-	-	-	-	-	•	•

Order information

Code	Package
EK-B01-TP-RMA	1 pcs.



Configuration and commissioning

By means of ETS5 software or later versions
Application program **APEKBO1TPRMA#.knxprod**
(download from www.ekinex.com)



Documentation

For more information see the technical documentation, download from www.ekinex.com





Gateway Modbus RS485 - KNX

GATEWAYS

Description

The Ekinex® Modbus RS485 - KNX Gateway performs a protocol conversion between a serial RS485 Modbus RTU and a KNX TP network. The device works as Modbus master. The device integrates a KNX bus communication module and it is suitable for mounting on a 35 mm DIN rail; it requires an auxiliary power supply.

Main features

- Plastic casing
- Connection to bus line with KNX terminal block
- Installation on 35 mm rail (according to EN 60715)
- 4 modular units (1 MU = 18 mm)
- IP20 protection degree (installed device)
- Weight 145 g

Technical data

- Power supply: 8...24 Vac or 12...35 Vdc
- Absorption at 24 Vdc: 3,5 VA

Communication

KNX side

- KNX TP (Twisted Pair) communication port electrically isolated from power supply
- 1440-byte volatile support "KNX image" memory buffer

Modbus RS485 side

- RS485 serial communication port, electrically isolated from power supply, 120 ohm termination resistance pluggable by a 1-way micro-switch
- Modbus master RTU (Remote Terminal Unit) communication
- Selectable baud rate from 1200 to 115200 baud
- Device addressing from 0 to 250
- Coil, Input, Holding Register e Input Register data exchange
- Single and multiple register reading/writing
- 1440-byte volatile support "Modbus image" memory buffer

Configuration

- Ethernet communication port (IEEE 802.3), RJ45 connector, minimum cable category: 5E

Delivery

The delivery includes the device and terminal blocks to connect to the KNX bus.

Other information

Modbus® is an open source, standard communication protocol suitable for master / slave data exchange between smart devices in various applications, such as industrial production, infrastructure, transportation and energy management.

Dimensions [mm]

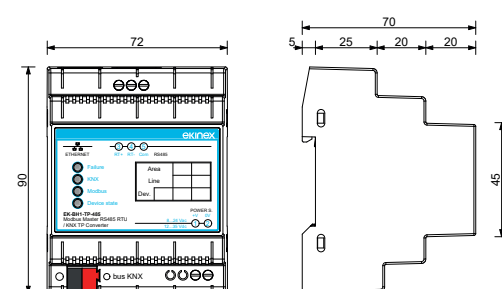

Configuration and commissioning

By means of software tool **CGEKBH1TP485.exe** (download from www.ekinex.com)



Documentation

For more information see the technical documentation, download from www.ekinex.com



Order information

Code	Application	Package
EK-BH1-TP-485	protocol conversion KNX - Modbus RTU	1 pcs.



Gateway Modbus TCP/IP - KNX

GATEWAYS

Description

The Ekinex® Modbus TCP/IP - KNX Gateway performs a protocol conversion between a Modbus RTU over TCP / IP and a KNX TP network. The device works as Modbus master. The device integrates a KNX bus communication module and it is suitable for mounting on a 35 mm DIN rail; it requires an auxiliary power supply.

Main features

- Plastic casing
- Connection to bus line with KNX terminal block
- Installation on 35 mm rail (according to EN 60715)
- 4 modular units (1 MU = 18 mm)
- IP20 protection degree (installed device)
- Weight 145 g

Technical data

- Power supply: 8...24 Vac or 12...35 Vdc
- Absorption at 24 Vdc: 3,5 VA

Communication

KNX side

- KNX TP (Twisted Pair) communication port electrically isolated from power supply
- 1440-byte volatile support "KNX image" memory buffer

Modbus TCP/IP side

- Ethernet communication port (IEEE 802.3), RJ45 connector, minimum cable category: 5E. Communication Modbus master RTU (Remote Terminal Unit)
- Device addressing from 0 to 250
- Coil, Input, Holding Register e Input Register data exchange
- Single and multiple register reading/writing
- 1440-byte volatile support "Modbus image" memory buffer

Configuration

- Ethernet communication port (IEEE 802.3), RJ45 connector, minimum cable category: 5E.

Delivery

The delivery includes the device and terminal blocks to connect to the KNX bus.

Other information

Modbus® is an open source, standard communication protocol suitable for master/ slave data exchange between smart devices in various applications, such as industrial production, infrastructure, transportation and energy management.

Dimensions [mm]

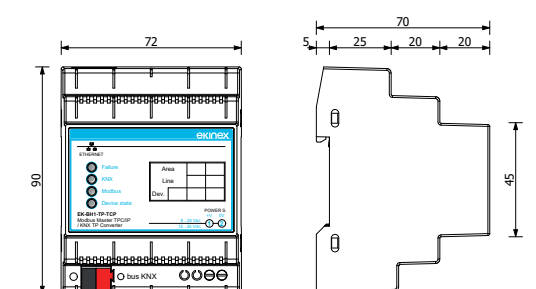

Configuration and commissioning

By means of software tool **CGEKBH1TPTCP.exe** (download from www.ekinex.com)



Documentation

For more information see the technical documentation, download from www.ekinex.com



Order information

Code	Application	Package
EK-BH1-TP-TCP	protocol conversion KNX - Modbus RTU	1 pcs.



Gateway BACnet - KNX

GATEWAYS

Description

The Ekinex® BACnet - KNX Gateway performs a protocol conversion between a BACnet and a KNX TP network. Two versions are available: BACnet MS/TP (master-slave / token-passed) over serial RS485 network and BACnet IP over Ethernet. The device integrates a KNX bus communication module and it is suitable for mounting on a 35 mm DIN rail; it requires an auxiliary power supply.

Main features

- Plastic casing
- Connection to bus line with KNX terminal block
- Installation on 35 mm rail (according to EN 60715)
- 4 modular units (1 MU = 18 mm)
- IP20 protection degree (installed device)
- Weight 145 g

Technical data

- Power supply: 8...24 Vac or 12...35 Vdc
- Absorption at 24 Vdc: 3,5 VA

Communication

KNX side

- KNX TP (Twisted Pair) communication port electrically isolated from power supply
- 1440-byte volatile support "KNX image" memory buffer

BACnet (MS/TP version) side

- RS485 serial communication port, electrically isolated from power supply, 120 ohm termination resistance pluggable by a 1-way micro-switch
- BACnet communication
- Selectable baud rate from 1200 to 115200 baud
- BACnet objects exchange
- 1440-byte volatile support "BACnet image" memory buffer

BACnet side (IP version)

- Ethernet communication port (IEEE 802.3), RJ45 connector, minimum cable category: 5E. Communication BACnet slave
- BACnet objects exchange
- 1440-byte volatile support "BACnet image" memory buffer

Configuration

- Ethernet communication port (IEEE 802.3), RJ45 connector, minimum cable category: 5E.

Delivery

The delivery includes the device and terminal blocks to connect to the KNX bus.

Other information

BACnet® is an ASHRAE (American Society of Heating, Refrigerating and Air-Conditioning Engineers) trademark.

Dimensions [mm]

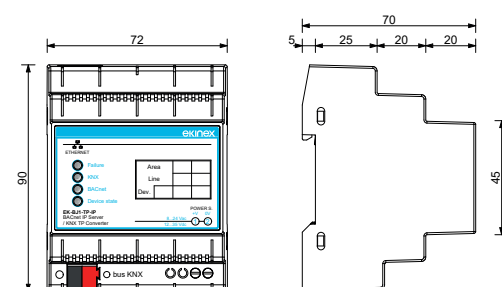

Configuration and commissioning

By means of software tool **CGEKB1TP.exe** (download from www.ekinex.com)



Documentation

For more information see the technical documentation, download from www.ekinex.com



MS/TP IP



Gateway DMX - KNX

GATEWAYS

Description

The Ekinex® DMX - KNX Gateway performs a protocol conversion between a serial RS485 DMX and a KNX TP network. The device works as DMX master. The device integrates a KNX bus communication module and it is suitable for mounting on a 35 mm DIN rail; it requires an auxiliary power supply.

Main features

- Plastic casing
- Connection to bus line with KNX terminal block
- Installation on 35 mm rail (according to EN 60715)
- 4 modular units (1 MU = 18 mm)
- IP20 protection degree (installed device)
- Weight 145 g

Technical data

- Power supply: 8...24 Vac or 12...35 Vdc
- Absorption at 24 Vdc: 3,5 VA

Communication

KNX side

- KNX TP (Twisted Pair) communication port electrically isolated from power supply
- 1440-byte volatile support "KNX image" memory buffer

DMX side

- RS485 serial communication port, electrically isolated from power supply, 120 ohm termination resistance pluggable by a 1-way micro-switch
- DMX master communication
- Baud rate 250 kbaud
- Device addressing from 0 to 512
- 1-byte register writing on max 512 DMX devices

Configuration

- Ethernet communication port (IEEE 802.3), RJ45 connector, minimum cable category: 5E

Delivery

The delivery includes the device and terminal blocks to connect to the KNX bus.

Other information

DMX512 is a standard for asynchronous serial transmission of digital data between controllers, devices and accessories for the light industry, approved by ANSI (American National Standards Institute) and supported by ESTA (Entertainment Services and Technology Association).

Dimensions [mm]

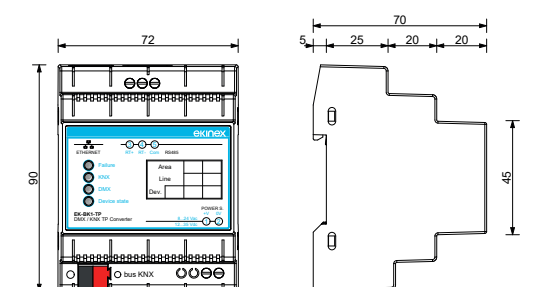

Configuration and commissioning

By means of software tool **CGEKB1TP.exe** (download from www.ekinex.com)



Documentation

For more information see the technical documentation, download from www.ekinex.com





Gateway M-Bus - KNX

GATEWAYS

Description

The Ekinex® M-Bus - KNX Gateway performs a protocol conversion between an M-Bus and a KNX TP network. The device acts as M-Bus master. Versions for networks with a maximum number of 20, 40, 80 and 160 connected M-Bus slave devices are available. The device integrates a KNX bus communication module and it is suitable for mounting on a 35 mm DIN rail; it requires an auxiliary power supply.

Main features

- Plastic casing
- Connection to bus line with KNX terminal block
- Installation on 35 mm rail (according to EN 60715)
- 4 modular units (1 MU = 18 mm)
- IP20 protection degree (installed device)
- Weight 145 g

Technical data

- Power supply: from M-Bus network
- Absorption at 24 Vdc: 3,5 VA (without load); 4, 5, 8 or 14 VA (resp. with 20, 40, 80 or 160 M-Bus devices)

Communication

KNX side

- KNX TP (Twisted Pair) communication port electrically isolated from power supply
- Baud rate 9600 baud
- 1440-byte volatile support "KNX image" memory buffer

M-Bus side

- M-Bus communication port (wired version, two-pole cable)
- Selectable baud rate from 300 to 9600 baud
- Device addressing from 1 to 250
- Variable reading through M-Bus slave device mapping
- 1440-byte volatile support "M-Bus image" memory buffer

Configuration

- Ethernet communication port (IEEE 802.3), RJ45 connector, minimum cable category: 5E

Delivery

The delivery includes the device and terminal blocks to connect to the KNX bus.

Other information

M-Bus (Meter-Bus) is a standard protocol for remote reading of data acquired from thermal energy, electricity, gas and water meters. M-Bus is fully compliant with EN 13757: Communication Systems for remote meter reading, parts 2 (Physical and connection layer) and 3 (Application layer).

Dimensions [mm]

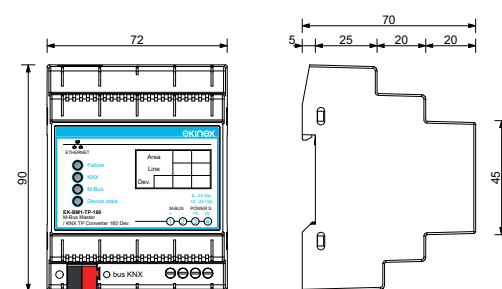

Configuration and commissioning
By means of software tool **CGEKBM1TP.exe** (download from www.ekinex.com)



Documentation
For more information see the technical documentation, download from www.ekinex.com



Gateway PROFINET - KNX

GATEWAYS

Description

The Ekinex® PROFINET - KNX Gateway performs a protocol conversion between a PROFINET and a KNX TP network. The device acts as slave of PROFINET communication. The device integrates a KNX bus communication module and it is suitable for mounting on a 35 mm DIN rail; it requires an auxiliary power supply.

Main features

- Plastic casing
- Connection to bus line with KNX terminal block
- Installation on 35 mm rail (according to EN 60715)
- 4 modular units (1 MU = 18 mm)
- IP20 protection degree (installed device)
- Weight 145 g

Technical data

- Power supply: 8...24 Vac or 12...35 Vdc
- Absorption at 24 Vdc: 3,5 VA

Communication

KNX side

- KNX TP (Twisted Pair) communication port electrically isolated from power supply
- 1440-byte volatile support "KNX image" memory buffer

PROFINET side

- Ethernet communication port (IEEE 802.3), RJ45 connector, minimum cable category: 5E. Communication PROFINET slave
- PROFINET data exchange
- 1440-byte volatile support "PROFINET image" memory buffer

Order information

Code	Application	Package
EK-BN1-TP	protocol conversion KNX - PROFINET	1 pcs.

Configuration

- Ethernet communication port (IEEE 802.3), RJ45 connector, minimum cable category: 5E.

Delivery

The delivery includes the device and terminal blocks to connect to the KNX bus.

Other information

PROFINET (Process Field Net) is an open source, Ethernet based (IEEE 802.xx) standard communication protocol, suitable for data exchange between field devices in industrial and process automation applications. The standard is supported by PROFIBUS & PROFINET International (PI) association.

Dimensions [mm]

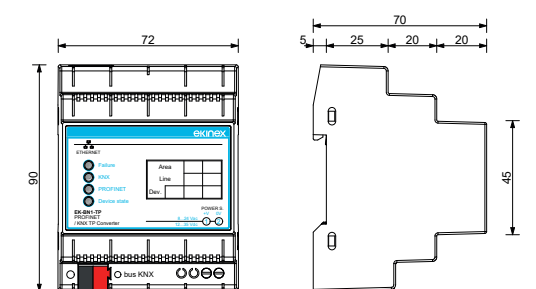

Configuration and commissioning
By means of software tool **CGEKBM1TP.exe** (download from www.ekinex.com)



Documentation
For more information see the technical documentation, download from www.ekinex.com





Gateway DALI - KNX

GATEWAYS



Voice control interface - KNX

GATEWAY

Description

The Ekinex® DALI - KNX Gateway allows the control of the devices present in a DALI network from a KNX TP network. The device has an integrated KNX bus communication module and integrates the power supply stage for the DALI bus.

Main features

- Connection to the KNX bus line with standard KNX terminal block
- Plastic casing
- Installation on 35 mm rail (according to EN 60715)
- 4 modular units (1 MU = 18 mm)
- IP20 protection degree (installed device)

DALI functions

- Control of up to 64 DALI devices in up to 16 groups
- Up to 16 light Scenes
- Broadcast function
- Individual, group or central addressing
- Suitable for operation in emergency lighting systems
- Readout of DALI device status via KNX (e.g. brightness or device error)

Configuration

- Application program for ETS v.5 for the configuration of the KNX functions of the device
- PC application program for the configuration of the device and of DALI appliances

Connections

- KNX port with standard connector
- Screw terminals (doubled) for the DALI bus
- Ethernet port (IEEE 802.3), RJ45 connector, category 5E cable (or higher)

Technical data

- Device power supply: 230 Vac
- Power supply output for the DALI bus: 12 VDC 250mA

Delivery

The delivery includes the device and terminal blocks to connect to the KNX bus.

Other information

DALI® (Digital Addressable Lighting Interface) is a worldwide standard protocol for lighting control interfacing systems, whose data exchange protocol is compliant with IEC 62386. DALI is a trademark of ZVEI (Zentralverband Elektrotechnik- und Elektronikindustrie e.V.).

DALI2 version available with firmware update 3.0.0

Dimensions [mm]

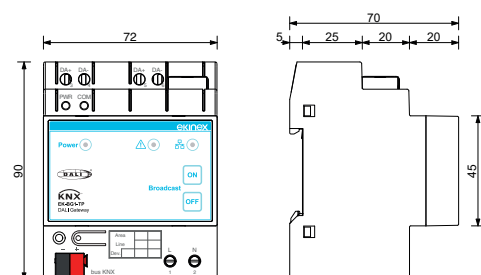

Description

Device with interface function between a KNX network (TP, twisted pair) and home speakers equipped with Amazon Alexa or Google Assistant. The interface, connected to Ekinex cloud services, is suitable for the control by voice commands of light, climate and motorization of a modern KNX standard building. The product is designed for installation on DIN profile rail and occupies 2 modules. The 12-24 Vdc power supply is external (power supply not included in the supply). The product with hardware based on embedded operating system, has a KNX TP node (twisted pair) and can therefore be connected directly to the bus network of KNX devices. The external connectivity is realized through the Ethernet port that connects the device directly to the home router.

The integrated web server provides access to the configuration environment and provides the following functions:

- Interface network settings
- Registration and subscription to Ekinex cloud services
- Automatic import of the ETS project and merging with previous imports
- Configuration of voice control accessories (max 150 accessories): lighting (on/off, dimmed and RGB), motorizations (open/close stop and position) and climate
- Configuration of action sequences on the KNX bus, which can be called up as scenarios by voice assistants
- Configuration of the IFTTT (If This Than That) cloud platform for the creation of association rules between events on the KNX bus and compatible services (e.g. sending e-mail)
- On the Amazon Alexa and Google Assistant apps, the Ekinex skill and action are available respectively for the complete configuration of the service.

Main features

- 12-24 Vdc power supply (absorption 240 mA at 12 Vdc) by means of a special plug-in terminal supplied. Power supply not included
- KNX TP bus (twisted pair) via red-black terminal provided
- 1 Ethernet port via cat. 5 or higher cable and standard RJ45 connector
- 2 frontal LEDs: POWER LED for signalling the presence of power supply; SERVICE LED for signalling particular operations in progress.
- 1 RESET button housed under the front cover on the back of the vertical card
- 1 RS485 port: not used
- 1 USB 2.0 port: not used

Dimensions [mm]

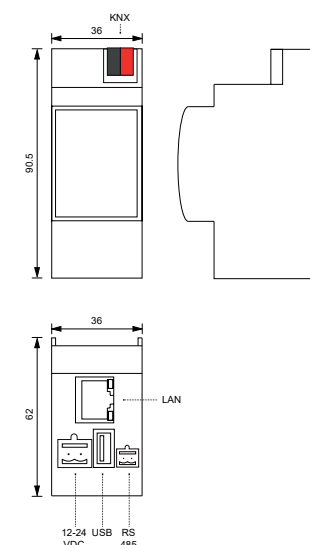

Order information

Code	Application	Package
EK-BG1-TP	protocol conversion KNX - DALI	1 pcs.



Configuration and commissioning

By means of the PC software **CGEKBG1TP.exe** and the ETS v.5 application program **APEKBG1TP##.knxprod** (download both from www.ekinex.com)



Documentation

For more information see the technical documentation, download from www.ekinex.com



Order information

Code	Application	Package
EK-BW1-TP	Voice control	1 pcs.



Configuration and commissioning

Through internet browser configurable both locally and remotely via cloud access.



Documentation

For more information see the technical documentation, download from www.ekinex.com





Konnect4 - KNX GATEWAY

Description

Modular KNX S-mode device with advanced IP-KNX interface function and integrated webserver. It offers a range of connectivity and functional services to a Control4 supervision system in installations with Ekinex KNX devices.

Main features

- Automatic network discovery via SDDP
- Bus line scanning and automatic assignment of addresses to connected EKINEX devices
- Identification of bus-connected devices within Composer Pro via SDDP
- Configuration of device operating parameters via device driver
- Downloading of configuration completely from Composer Pro without ETS
- Interfacing of configured devices with other devices, including third-party devices, via device connections

Technical data

- Power supply 12/24 Vdc
- Power consumption 3W (240mA at 12V)
- Ethernet LAN connection port
- Plastic housing
- Design for 35 mm mounting rail (according to EN 60715)
- Degree of protection IP20 (according to EN 60529)
- Insulation class II (according to EN 60335-1)
- Weight 70 g
- 2 UM modular device (1 UM = 18 mm)
- Dimensions 36 x 94 x 71 mm (W x H x D)

Dimensions [mm]

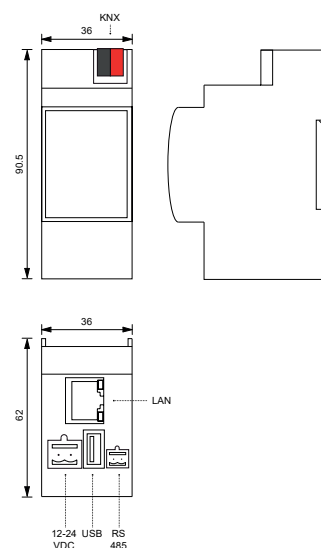

Order information

Code	Application	Package
EK-BR1-TP	KNX and/or Control4 interface	1 pcs.



Documentation

For more information see the technical documentation, download from www.ekinex.com



Gateway KNX / DALI 1 canale GATEWAY

Description

Ekinex® Gateways EK-BF1-TP-D1 is a device used to control electronic control gear (ECG) with a DALI interface (according to EN 62386) via the KNX installation bus. The device converts switching and dimming commands from the connected KNX system into DALI telegrams and status information from the DALI bus into KNX telegrams.

Connections

- KNX port with standard connector
- Screw terminals for DALI bus

Technical data

- Device power supply: 110-240 Vac or DC
- KNX bus power supply

Supply

The scope of delivery includes a terminal for connection to the KNX bus line and a 1.2 x 2 cm heat shrink tubing for additional insulation of the bus cable.

Other information

DALI® (Digital Addressable Lighting Interface) is a worldwide standard for interfacing lighting control solutions whose data transmission protocol is contained in IEC 62386. DALI is a registered trademark of ZVEI (Zentralverband Elektrotechnik- und Elektronikindustrie e.V.).

With firmware version 0.2.5 or higher, the device is certified according to EN 62386-101 and -103 ed2 (DALI2) and therefore authorised to carry the DALI-2 logo.

Main features

Besides the pure gateway function, the EK-BF1-TP-D1 also offers numerous additional functions:

- Addressing of up to 16 DALI groups or 63 individual ECGs
- Flexible DALI commissioning concept with ETS5
- Light colour control using type 8 ECG devices
- Light colour control according to different ECG subtypes
- Hourly programming for group and ECG control by value and/or colour
- Different operating modes such as permanent mode, night mode or staircase mode
- Integrated operating hours counter for each group and ECG with alarm when maximum duration is reached
- Individual fault recognition with objects for each lamp / ECG
- Complex failure analysis at group/device level with calculation of the number of failures and failure rate
- Fault threshold monitoring with individually configurable threshold values
- Scene module for extensive scene programming and dimming possibilities
- Quick replacement' function for easy replacement of individual defective ECGs
- Manual control of group and broadcast telegrams via control buttons on the device
- Fault status signalling via LED on the device

Dimensions [mm]

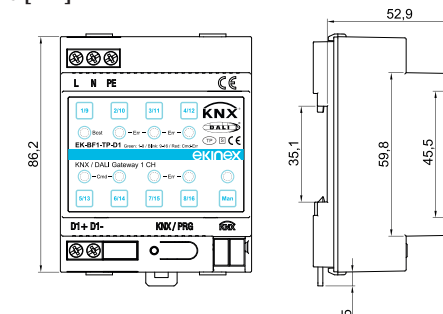

Configuration and commissioning

ETS application v.5 and 6 for configuring the KNX functions of the device. DCA App as special interface for configuring DALI segments.



Documentation

For more information see the technical documentation, download from www.ekinex.com





Gateway KNX / DALI 2 canali

GATEWAY

Description

Ekinex® Gateways EK-BF1-TP-D2 is a device used to control electronic control gear (ECG) with a DALI interface (according to EN 62386) via the KNX installation bus. The device converts switching and dimming commands from the connected KNX system into DALI telegrams and status information from the DALI bus into KNX telegrams.

Connections

- KNX port with standard connector
- Screw terminals for DALI bus

Technical data

- Device power supply: 110-240 Vac or DC
- KNX bus power supply

Supply

The scope of delivery includes a terminal for connection to the KNX bus line and a 1.2 x 2 cm heat shrink tubing for additional insulation of the bus cable.

Other information

DALI® (Digital Addressable Lighting Interface) is a worldwide standard for interfacing lighting control solutions whose data transmission protocol is contained in IEC 62386. DALI is a registered trademark of ZVEI (Zentralverband Elektrotechnik- und Elektronikindustrie e.V.).

With firmware version 0.2.5 or higher, the device is certified according to EN 62386-101 and -103 ed2 (DALI2) and therefore authorised to carry the DALI-2 logo.

Main features

Besides the pure gateway function, the EK-BF1-TP-D2 also offers numerous additional functions:

- Addressing of up to 2x16 DALI groups or 2x63 individual electronic ballasts
- Flexible DALI commissioning concept with ETS5
- Light colour control using type 8 ECG devices
- Light colour control according to different ECG subtypes
- Hourly programming for group and ECG control by value and/or colour
- Different operating modes such as permanent mode, night mode or staircase mode
- Integrated operating hours counter for each group and ECG with alarm when maximum duration is reached
- Individual fault recognition with objects for each lamp / ECG
- Complex failure analysis at group/device level with calculation of the number of failures and failure rate
- Fault threshold monitoring with individually configurable threshold values
- Scene module for extensive scene programming and dimming possibilities
- Quick replacement' function for easy replacement of individual defective ECGs
- Manual control of group and broadcast telegrams via control buttons on the device
- Fault status signalling via LED on the device

Dimensions [mm]

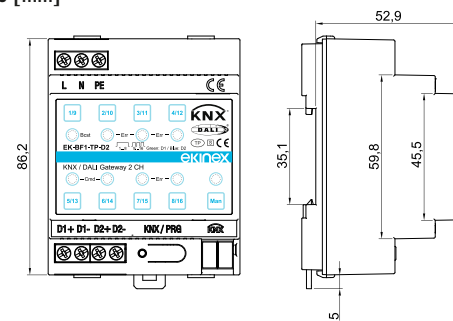

Configuration and commissioning

ETS application v.5 and 6 for configuring the KNX functions of the device. DCA App as special interface for configuring DALI segments.



Documentation

For more information see the technical documentation, download from www.ekinex.com



Metering

DIN-RAIL MOUNT MODULES

EK-ME1-750-TP
Three-phase MID electricity meter 75A

EK-ME1-5TA-TP
Three-phase MID electricity meter 5A



Three-phase energy meter	•	•
Single-phase energy meter	•	•
Direct connection	•	-
Fully bi-directional four quadrants measurements for all energies and powers	•	•
Main electrical parameters measured and displayed for a cost-effective consumption analysis	•	•
For 3 / 4 wire networks with balanced or unbalanced load	•	•
Class B according to EN 50470-3	•	•
Tariff Input	•	•
2 SO outputs for energy pulse emission	•	•
LCD-Display	•	•
Sealable cover to prevent tampering	•	•
MID Certificate	•	•
KNX protocol	•	•
Communication speed: 9600 bps	•	•
Mounting on standard 35 mm rail (EN 60715)	•	•



Three-phase MID electricity meter 75A

METERING

Description

Three-phase MID energy meter for active and reactive energy measurement with bi-directional metering for imported and exported energy, current (A), voltage (V), active power (kW), reactive power (kVAr), power factor and other electrical parameters. Direct connection up to 75 A. The device has an integrated communication module to the KNX bus.

The meter has four SO pulse outputs for the transmission of imported and exported active and reactive energy data, which can alternatively be used for load control functions or for threshold monitoring of a maximum value. The device enables two- or four-rate system management with switching of the active rate via a 230 Vac signal. Protection against manipulation is provided by sealable terminal covers. The device is designed for DIN rail mounting according to EN 60715 inside switchboards and control cabinets.

Functions

- Display: graphic 60x30 mm LCD backlit
- Optical interface DO: according to EN 62056-21
- Communication interface: KNX TP
- KNX configuration: via ETS software
- Metrological LED: 10 pulses / Wh
- Pulse output: Opto Power MOSFET SO for heavy-duty applications, 5-230 Vac or Vdc, max 90 mA
- Pulse setting (frequency, length)
- Accuracy class: B (1%)
- Environmental class: mechanic: M1, electromagnetic: E1
- Safety class: 2
- Marks: KNX, CE, MID (B+D)
- Device housing: modular 5 MU (1 MU = 18 mm)
- Degree of protection: IP51 (housing), IP20 (terminals)
- Dimensions (LxHxD): 90 x 90 x 67 mm

Technical data

Power supply

- Rated voltage Un: 3x230 / 400V (+/- 20%)
- Rated frequency fn: 50 Hz, 60 Hz on request

Voltage

- Direct connection: (Ist, Imin, Itr, Iref, Imax) 0.02 A / 0.25 A / 0.5 A / 5 A / 75 A (5(75))

Dimensions [mm]

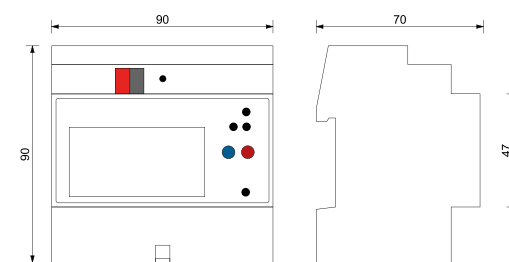

Order information

Code	Device	Package
EK-ME1-75D-TP	Three-phase MID electricity meter 75A	1



Configuration and commissioning

By means of ETS5 software or later versions
Application program **APEKME1EMUTP##.knxprod**
(download from www.ekinex.com)



Documentation

For more information see the technical documentation,
download from www.ekinex.com



Three-phase MID electricity meter 5A

METERING

Description

Three-phase MID energy meter for active and reactive energy measurement with bi-directional metering for imported and exported energy, current (A), voltage (V), active power (kW), reactive power (kVAr), power factor and other electrical parameters. Connection via current transformers (CT). The device has an integrated communication module to the KNX bus.

The meter has four SO pulse outputs for the transmission of imported and exported active and reactive energy data, which can alternatively be used for load control functions or for threshold monitoring of a maximum value. The device enables two- or four-tariff system management with switching of the active rate via a 230 Vac signal. Protection against manipulation is provided by sealable terminal covers. The device is designed for DIN rail mounting according to EN 60715 inside switchboards and control cabinets.

Functions

- Display: graphic 60x30 mm LCD backlit
- Optical interface DO: according to EN 62056-21
- Communication interface: KNX TP
- KNX configuration: via ETS software
- Metrological LED: 10 pulses / Wh
- Pulse output: Opto Power MOSFET SO for heavy-duty applications, 5-230 Vac or Vdc, max 90 mA
- Pulse setting (frequency, length)
- Accuracy class: B (1%)
- Environmental class: mechanic: M1, electromagnetic: E1
- Safety class: 2
- Marks: KNX, CE, MID (B+D)
- Device housing: modular 5 MU (1 MU = 18 mm)
- Degree of protection: IP51 (housing), IP20 (terminals)
- Dimensions (LxHxD): 90 x 90 x 67 mm

Technical data

Power supply

- Rated voltage Un: 3x230 / 400V (+/- 20%)
- Rated frequency fn: 50 Hz, 60 Hz a richiesta

Voltage

Current transformer /5A and /1A:

- /5A (Ist, Imin, Itr, Iref, Imax) 0.01 A / 0.05 A / 0.25 A / 5 A / 6 A (5(6))
- /1A (Ist, Imin, Itr, Iref, Imax) 0.002 A / 0.01 A / 0.05 A / 1 A / 1.2 A (1(1.2))

Dimensions [mm]

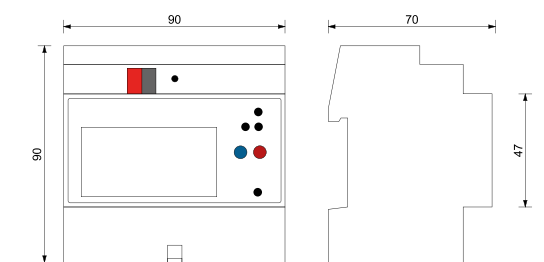

Order information

Code	Device	Package
EK-ME1-5TA-TP	Three-phase MID electricity meter 5A	1



Configuration and commissioning

By means of ETS5 software or later versions
Application program **APEKME1EMUTP##.knxprod**
(download from www.ekinex.com)



Documentation

For more information see the technical documentation,
download from www.ekinex.com





Terminal blocks

ACCESSORIES

Description

Terminal block for the connection of KNX bus lines or SELV auxiliary power supply. It allows the connection of max. 4 pairs of wires. To be used also as distribution terminal in wall boxes.

Colour coding

- EK-MNR-TP: red = + (positive), black = - (negative)
- EK-MGB-TP: yellow = + (positive), white = - (negative)

Main features

- 4 plug-in seats for each polarity
- Fast spring connection
- Suitable for solid wire diameter 0,6÷0,8 mm
- Mechanical coding for terminal block housing on devices
- Wire strip length (advised) 5-6 mm

Order information

Code	Colour coding	Use	Package
EK-MNR-TP	red/black	bus connection	50
EK-MGB-TP	yellow/white	SELV connection	50

Technical data

- Nominal voltage 100 V
- Nominal current 6 A

Delivery

Package of 50 pieces.

Note

A terminal block for the connection of KNX bus line (EK-MNR-TP) is supplied with every

Ekinex® device. A terminal block for the connection of SELV auxiliary power supply is supplied along with EK-AG1-TP power supply and Touch&See unit.

Dimensions [mm]

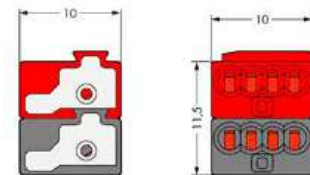

EK-MNR-TP EK-MGB-TP



Bus cable

ACCESSORIES

Description

The bus cable LSHF (Low Smoke Halogen Free) is a twisted pair cable for the connection of KNX bus devices and the derivation of KNX bus lines. It is available with a single pair of wires with a diameter of 0.8 mm. Screen in aluminium foil. For use in dry interior.

Main features

- Cable for KNX based applications (TP)
- Single pair of wires Ø 0,8 mm
- Black/red wires for KNX bus line connection
- Yellow/white wires for auxiliary SELV or spare power supply

Order information

Code	Type	Use	Package [m]
EK-112-TP	1 x 2 x 0,8	bus connection	100
EK-114-TP	2 x 2 x 0,8	bus connection and spare pair	100

Technical data

- Nominal voltage: 50 V
- Test voltage: 4 kV

Delivery

100 m bundle covered with cellophane.



EK-112-TP EK-114-TP

deleogo
does it for you

SUPERVISION

Ekinex Delégo: the system	317
Renewed graphic interface	318
Simplified configuration and maintenance	321
Complete versatility	322
Main features - Licenses	323
Delégo server	324
Delégo mini	325
Delégo panel	326





Ekinex Delégo: the system

SUPERVISION

Delégo is a system for the supervision and control of a KNX home automation system. Developed with web-oriented technologies, it has a uniform interface with high graphical impact on every platform, both desktop (PC) and mobile (Apple iOS and Android devices), with both local and remote connection. The system consists of a compact server (based on Linux operating system) to be installed in an electrical box: the device connects directly to the KNX bus via twisted pair; the connection to the home router is made via the Ethernet port on your local network (LAN).

The user can interact with the system either by means of mobile devices, or with one or more fixed stations, by means of Delégo panel a touch-panel with elegant and minimal design, for wall installation, connected via Ethernet port on its local network (LAN). The Delégo supervision system is characterized by a simple and at the same time extremely complete configuration, thanks to the direct import of the ETS project file. The functional definition of the various imported domotic objects and the correspondence with a rich and customizable set of controls (widgets) for the user, is also very straightforward.

The renewed interface is simple and intuitive and allows the user to interact with the home automation system of his smarthome through the use of different devices, with absolute uniformity of use. The app allows you to remotely control lights, climate, automatism, audio/video equipment, shutters and more with a simple touch, from a single device and from anywhere in the building reached by the Wi-Fi network, or remotely via web connection.



Renewed graphic interface

SUPERVISION

The redesigned visual interface can be accessed either via an app for smartphone and tablet (supported operating systems: Apple iOS and Android) or from a desktop PC workstation. All the devices can be interfaced with the server previously configured so that all the functions of the automation system can be controlled and viewed. The app, accessible from mobile devices (smartphones and tablets) or fixed devices (Delégo panel), is structured for the logical vision of the building, by areas or services. The supervision with desktop PC also allows the visualization with synoptic: the plan of the space can be associated, following the physical location, with the set of available services.

VISUALIZATION BY AREAS

The app will display a list of configured areas, each identified by an image inserted in the web configurator during the commissioning phase:

In each area set through the web configurator (for example: living room, bedroom, kitchen) the user can choose whether to turn on or off the lights, or to change the settings of the room thermostat and other settings for each of the available features; Simple navigation between the different areas configured with a touch of the display.

VISUALIZATION BY SERVICES

The visualization of each area can be filtered through a toolbar that allows you to easily select the individual function available:

Lighting

Air conditioning

Shading and motorized automations

Scenarios

The app can be extended with the functions provided by the compatible video surveillance, intrusion detection and audio/video systems integrated in the Delégo server.



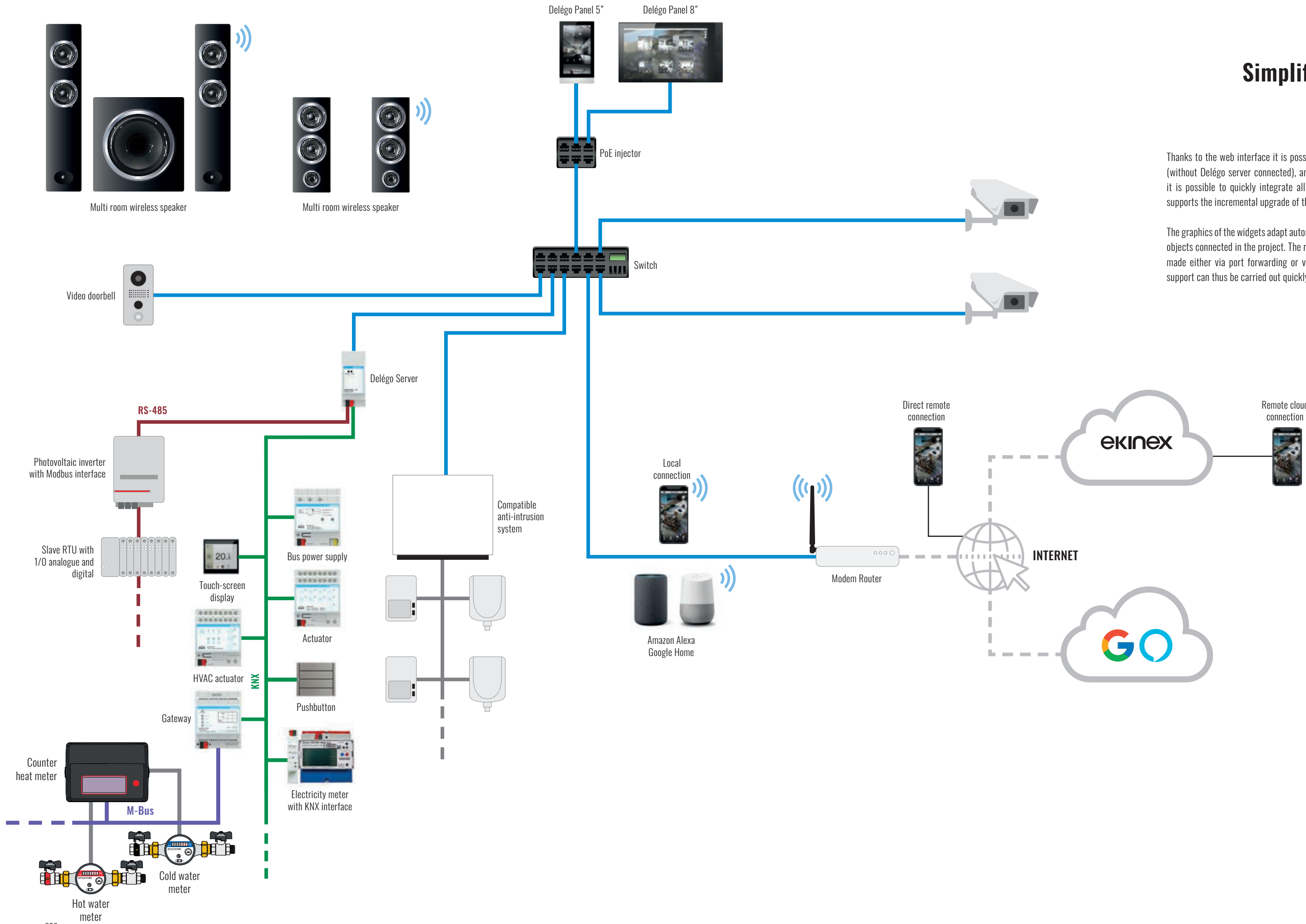

Simplified configuration and maintenance

SUPERVISION

Thanks to the web interface it is possible to program the system online and offline (without Delégo server connected), and thanks to the ETS' project file import tool, it is possible to quickly integrate all the group addresses used. The system also supports the incremental upgrade of the installation via subsequent imports.

The graphics of the widgets adapt automatically according to the KNX communication objects connected in the project. The remote connection of the Delégo server can be made either via port forwarding or via native cloud connection. Maintenance and support can thus be carried out quickly and with reduced running costs.

Complete versatility

SUPERVISION

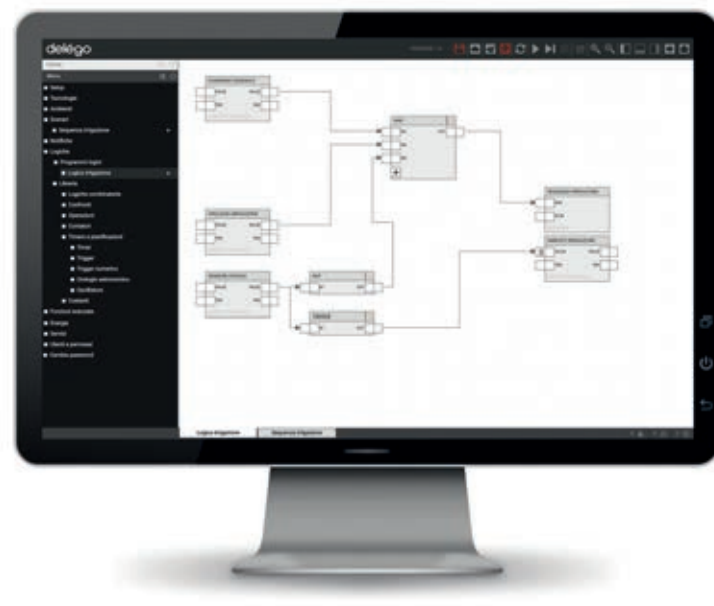

Multiplatform

Delégo server can be managed by PC, MAC, Touch-PC, smartphone and tablet through a common Internet browser or with a free dedicated app (available for Apple devices and Android).

Customizable

the graphics and automatic functions of Delégo server can be easily modified according to your needs, accessing the web pages with your PC of administration.

Quick to configure

Delégo server proposes a set of ready-to-use functions typically used in the home automation supervisors and allows you to quickly import the structure of your own ETS building (KNX installation).

Multi-protocol

Delégo server can be connected directly to both the KNX bus in the twisted version pair, both to Modbus on RS485 network and via TCP/IP protocol via Ethernet port. Thanks to the multi-protocol management it is possible to connect intrusion detection systems, thermoregulation, multimedia systems and video surveillance.

Easy to install

Thanks to the size of only 2 modules on DIN rail, Delégo server can be easily installed directly into the electrical cabinet. The communication ports to the LAN, KNX bus and other technological subsystems do not require any additional external interfaces.

Reliable

The Delégo server is based on a Linux operating system that guarantees reliability and stability. of the platform for continuous use, as well as providing a high degree of safety on the net.

Also offline

It is possible to build the supervision project even without being connected to the webserver, working in "offline" mode directly on your PC or MAC.

100% Made in Italy

Hardware and software are designed, manufactured, assembled and tested entirely in Italy, to guarantee the highest quality of the product and after-sales service competent and helpful.

Main features

SUPERVISION

SOFTWARE FEATURES

Standard technologies	KNX RS-485 / TCP / UDP configurable Modbus RTU/TCP	
User Interface	Web / HTMLS (All operating systems) Dedicated app (iOS Android)	
Number of users	Unlimited without additional licenses	
Synchronized connections	Up to 20 (scalable on request)	
Technological systems	Lighting Heating / air conditioning Motorized doors and windows Irrigation Thermal power plant thermoregulation Technical alarms Consumption and energy management Load control Weather control IP Cameras / IP Door phones Intrusion detection Audio/Video broadcasting	
Compatibility of operating systems	Microsoft Windows Apple Mac OSX Linux	Apple iOS Android

VISUALIZATION

Layout	Graphics scalable by resolution Automatic recognition of mobile devices Full support for touch and multi-touch devices
Navigation	Personalized graphic pages Multi-level environment navigation Navigation by functions Summary popups for the most complex functions Always accessible and customizable menu
Customization	Scenarios, Calendar schedules
Notifications and messages	Notifications on screen, Email, Push notifications
Cloud Services	Remote Accessibility, Weather Services, IFTTT

SETUP AND CONFIGURATION

Configuration mode	Online Offline via free downloadable tool
Environment of configuration	Integrated search engine Navigation tree for access to all functions Drag & drop Multi-tab for multiple simultaneous configuration functions
Setup and maintenance	Network Date and time Backup / stay configuration via browser Language selection Graphic Themes Selection and Layout Customization Software update via browser
Environments / graphic pages	Grid layout and graphic map Customizable background images Custom Object Sorting/Placement
Advanced Functions	Scenarios with timings Logics Comparison of values and levels Mathematical operations Custom functions via scripting
Planning and calendar	Unlimited number of daily profiles for each object Weekly and annual profiles Configuration accessible by end user
Energy Management	Support for KNX network analyzers, ModBus Integrated load control function Graphical visualization of consumption and production Real-time load absorption display Automatic comparisons and consumption indicators
Voice Control	Amazon Alexa - Google Assistant
Users and security	Unlimited number of users Unlimited access Secure SSL access via internet



Delégo server

SUPERVISION

Description

Web supervisor for home and building automation systems based on the KNX system. It allows to manage the functions present in the building through any type of device (PC/MAC, touch-PC, smartphone, tablet) as long as it is equipped with a web browser, both locally and remotely through internet. Customizable graphics suitable for any context and application, optimized for visualization on different fixed and mobile platforms. Simplified and fast configuration of KNX functions. Possibility to realize scenarios, time sequences, logics, conditions, operations mathematics, temporal planning through simple graphical tools and intuitive: reporting events and alarms on screen or via email. Configuration online or offline via free downloadable PDF tool: does not require programming or HTML skills for supervision customization. Interfacing with other communication technologies and protocols by enabling additional modules.

Main features

- **Dimensions:** 90.5 x 62 x 36 mm 2 DIN modules
- **Power supply** 12 - 24 VDC Plug-in terminal provided
- **Absorption** 240mA at 24V
- **Connections** LAN (RJ45)
KNX (standard red-black connector)
RS485 (terminal supplied)
USB
- **LED** Power
Service / Reset
- **Degree of protection** IP 20 (according to EN 60529)
- **Insulation class** II (according to EN 60335-1)
- **Operating temperature** +0°C ... +40°C
- **Storage temperature** 10°C ... +70°C

Dimensions [mm]

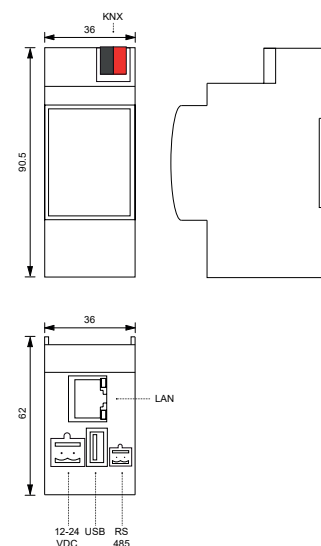

Documentation

For more information see the technical documentation, download from www.ekinex.com



Order information - Licenses

Code	Composition	License version	KNX Addresses	Scenarios	Logics/Thresholds	Environments	Loads	Cameras	Package
EK-DEL-SRV-BAS-200-TP	Delégo server	BASIC	200	100	100	Unlimited	Unlimited	Unlimited	1 cs.
EK-DEL-UPGR-BA		ADVANCED	1200	100	100	Unlimited	Unlimited	Unlimited	
EK-DEL-UPGR-BP	Upgrade License	PREMIUM	2500	100	100	Unlimited	Unlimited	Unlimited	
EK-DEL-UPGR-200		UPG. 200 ADRESSES	200						
EK-DEL-V1-INTRDET		Intrusion Integration				Upgrade codes and vouchers are activated in the Delégo Tech Portal.			
EK-DEL-V1-MBUS	Voucher	M-Bus integration				The portal is accessible by typing voucher.ekinex.com into your browser: when you log in for the first time, you can register and obtain your login credentials. Use is very simple: by typing in the code on the purchased voucher or by using the practical QR code and using the serial code on the side label of the server device, it is possible to generate a licence code for a specific Delégo function or the extension to a larger number of group addresses.			
EK-DEL-V1-MODBUS		Modbus extension over 30 registers							
EK-DEL-V1-VOIP		IP Video Door Entry Integration							



Delégo mini

SUPERVISION

Description

Delégo mini is the web supervisor for managing small installations based on the KNX system. It allows you to manage the functions in the building via any type of device (PC/MAC, touch-PC, smartphone, tablet), as long as it has a web browser, either locally or remotely via the Internet.

Main features

- **Dimensions:** 90.5 x 62 x 36 mm 2 DIN modules
- **Power supply** 12 - 24 VDC Plug-in terminal provided
- **Absorption** 240mA at 24V
- **Connections** LAN (RJ45)
KNX (standard red-black connector)
RS485 (terminal supplied)
USB
- **LED** Power
Service / Reset
- **Degree of protection** IP 20 (according to EN 60529)
- **Insulation class** II (according to EN 60335-1)
- **Operating temperature** +0°C ... +40°C
- **Storage temperature** 10°C ... +70°C

Dimensions [mm]

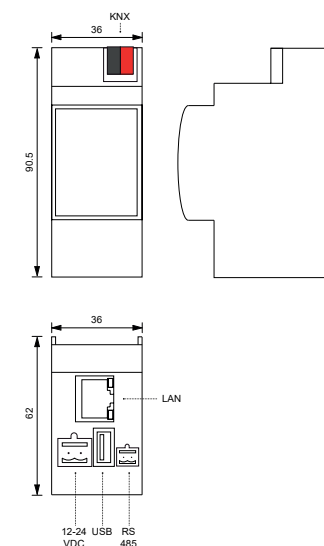

Documentation

For more information see the technical documentation, download from www.ekinex.com



Informazioni per l'ordine

Code	Composition	KNX Addresses	Scenarios	Combinatorial Logics	Environments	Loads	Package
EK-DEL-MINI-TP	Delégo mini	max 200	20	20	12	SI	1 cs.

Delégo panel SUPERVISION



Description

The touch-panels of the Delégo series are a must-have instrument for the management of the modern connected building. Through these you can control all the automation functions of the premises: lights, roller shutters, burglar alarm, climate control, building management, etc. energy saving and multimedia system. Delégo touch-panels are available in two cuts, from 5" to 10" capacitive display, with black frame. The elegance of the minimalist design, the exceptional graphic of the HD display and the outstanding performances, make Delégo panel ideal for home, office, businesses, and any other area of installation. Possibility of customization through aluminium frame (5" version only).

Dimensions [mm]

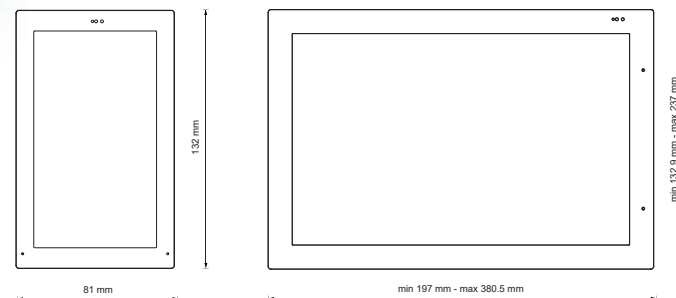

Delégo panel Basic

5" Basic



Code	EK-DEL-5PAN
Power supply	Power Over Ethernet (PoE)
Connectivity	LAN 100baseT
Display	LCD HD IPS TFT
Colours	16.7 million colours (true colour)
Resolution	720 x 1280 px
Touch screen	capacitive with multi-touch & gesture support
Speakers	high definition audio with built-in amplifier, 1W
Integrated microphone	high resolution
Operating system	Android 6
Certifications	CE / FCC class B / FCC part 15 / RoHS / WEEE
Dimensions (W x H x D) mm	132 x 81 x 14
Orientation	portrait
Plastic frame	black
External frame	aluminium
Compatible flush-mounting box	2M flush mounting box (e.g. BTicino mod. 502E); round box diameter 60 mm (e.g. Gewiss mod. 24232) 3M flush mounting box vertical mounting (e.g. BTicino mod. 503E)

Delégo panel Premium

5" Premium

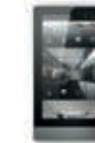

Code	EK-DEL-5PAN-P
Power supply	Power Over Ethernet (PoE)
Connectivity	LAN 100baseT
Display	LCD HD IPS TFT
Colours	16.7 million colours (true colour)
Resolution	1080 x 1920 px
Touch screen	capacitive with multi-touch & gesture support
Speakers	high definition audio with built-in amplifier, 4W
Integrated microphone	high resolution with echo cancelling
Operating system	Android 11
Certifications	CE / FCC class B / FCC part 15 / RoHS / WEEE
Dimensions (W x H x D) mm	132 x 81 x 14
Orientation	portrait
Plastic frame	black
External frame	aluminium
Compatible flush-mounting box	2M flush mounting box (e.g. BTicino mod. 502E); round box diameter 60 mm (e.g. Gewiss mod. 24232); 3M flush mounting box vertical mounting (e.g. BTicino mod. 503E)

Delégo panel Smart

4" Smart



8" Smart



10" Smart



Code	EK-DEL-4PAN-S	EK-DEL-8PAN-S	EK-DEL-10PAN-S
Power supply		Power Over Ethernet (PoE)	
Connectivity		LAN 100baseT	
Wi-Fi		IEEE802.11 b/g/n	
Bluetooth		Bluetooth 4.2	Bluetooth 5.0
Display		LCD HD IPS TFT	
Colours		16.7 million colours (true colour)	
Resolution	480 x 480 px		1280 x 800 px
Touch screen		capacitive with multi-touch & gesture support	
Speakers	single 8Ω / 1.5W		4 speakers 4Ω / 2W
Integrated microphone	double microphone -42dB		double microphone -26dB
Operating system	Android 10		Android 12
SIP Server	NO		SI
Certifications		CE / FCC class B / FCC part 15 / RoHS / WEEE	
Dimensions (W x H x D) mm	86.4 x 86.4 x 11.8	216.2 x 124.4 x 11.8	278.5 x 165.1 x 11.8
Orientation	portrait		landscape
Plastic frame		black	
Compatible flush-mounted box	2M flush-mounting box (e.g. BTicino mod. 502E); 65x45 mm diameter round box (e.g. Gewiss mod. GW24234PM)		2M flush mounting box (e.g. BTicino mod. 502E); round box diameter 60 mm (e.g. Gewiss mod. 24232) 3M flush mounting box vertical mounting (e.g. BTicino mod. 503E)



Documentation

For more information see the technical documentation, download from www.ekinex.com



MULTIROOM AUDIO SYSTEM

Streaming Amplifier	342
Speakers	347
Speakers by Laboratorio Audio	349





Sentio
MULTIROOM AUDIO SYSTEM

Listen to your favourite music in any room in your home.
Sentio brings the magic of sound to every room, transforming your listening experience into emotion.

Product range

Streaming amplifier						
	Streaming amplifier 30W	Streaming amplifier 50Wx2	Streaming amplifier 80Wx2	Streaming amplifier 50Wx8		
Speakers						
	Wall-mounted audio speaker IP66 (pair) - black	Wall-mounted speaker IP66 (pair) - white	2-way built-in speaker (single)			
Speakers Ekinex by Laboratorio audio						
	Q series	R series	T series	SUB	Omni/Iride	Modulor

Ethernet

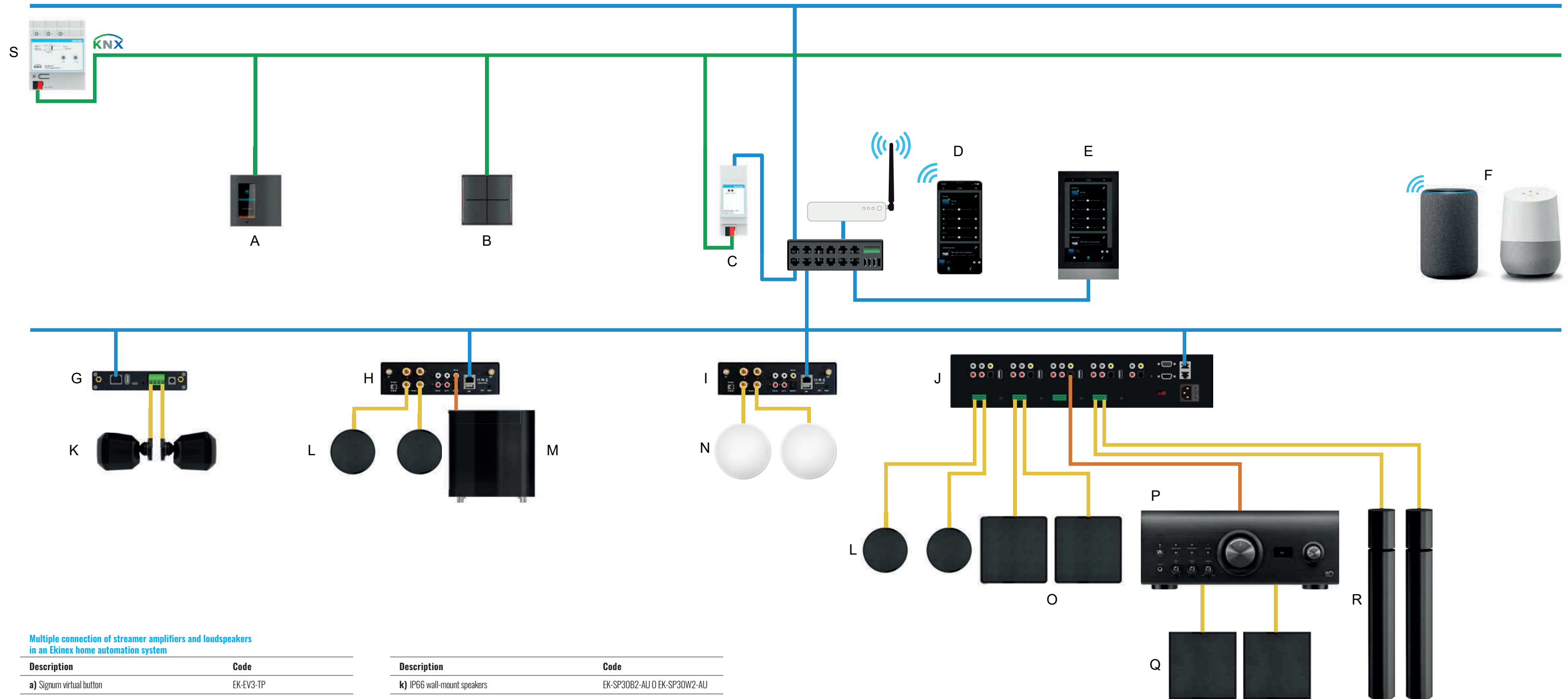

Multiple connection of streamer amplifiers and loudspeakers in an Ekinex home automation system

Description	Code
a) Signum virtual button	EK-EV3-TP
b) FF series wall-mount device	EK-ED2-TP
c) Delégo Server	EK-DEL-SRV-BAS-200-TP
d) Sentio App for mobile devices	
e) Delégo 5" panel	EK-DEL-5PAN O EK-DEL-5PAN-P
f) Amazon Alexa - Google Home voice command support	
g) 30W streamer amplifier	EK-30S-AU
h) Streamer amplifier 50Wx2	EK-50S-AU
i) Streamer amplifier 80Wx2	EK-80S-AU
j) 50Wx8 streamer amplifier	EK-50Q-AU

Description	Code
k) IP66 wall-mount speakers	EK-SP30B2-AU O EK-SP30W2-AU
l) T series speakers	EK-T...
m) Subwoofers	EK-K... O EK-Q5... O EK-Q6...
n) 2-way in-ceiling speakers	EK-SP525-AU
o) R series speakers	EK-R...
p) External amplifier box (not supplied by Ekinex)	
q) Q series speakers	EK-Q...
r) Omni/Iride series speakers	EK-OMNI... O EK-IRIDE...
s) BUS power supply	EK-AB1-TP

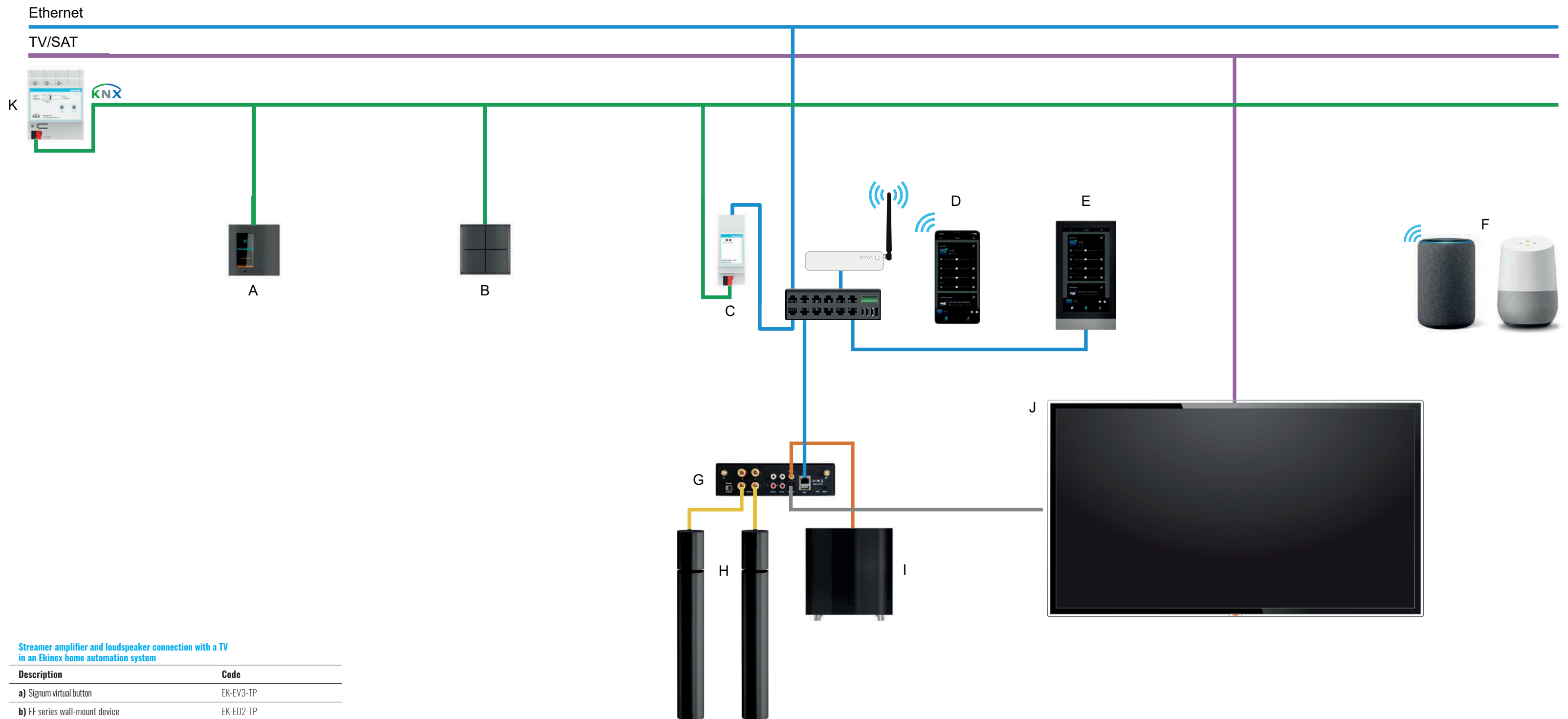

Streamer amplifier and loudspeaker connection with a TV in an Ekinex home automation system

Description	Code
a) Signum virtual button	EK-EV3-TP
b) FF series wall-mount device	EK-ED2-TP
c) Delégo Server	EK-DEL-SRV-BAS-200-TP
d) App Sentio/Delégo for mobile devices	
e) Delégo panel 5"	EK-DEL-5PAN o EK-DEL-5PAN-P
f) Amazon Alexa - Google Home voice command support	
g) Streamer amplifier 50Wx2	EK-50S-AU
h) Omni/Iride series speakers	EK-OMNI-... o EK-IRIDE-...
i) Subwoofer	EK-K-... o EK-Q5-... o EK-Q6-...
j) TV (not supplied by Ekinex)	
k) BUS power supply	EK-AB1-TP

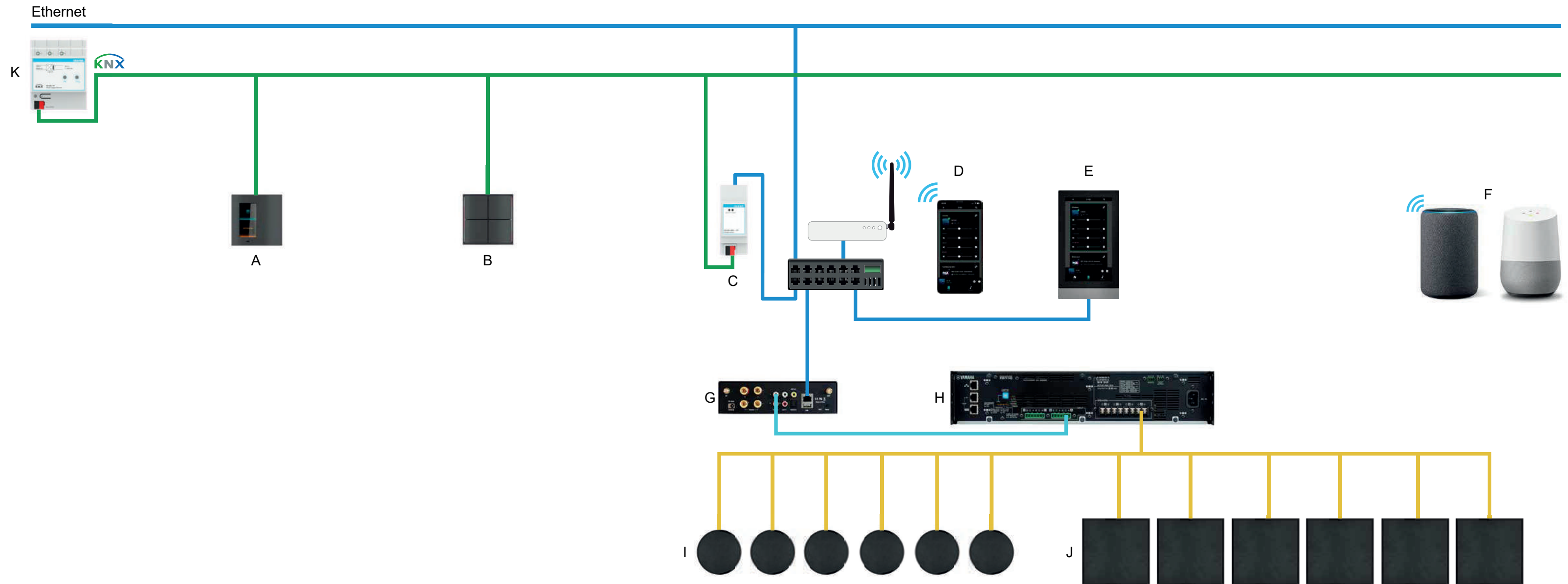

Streamer amplifier and speaker connection with an external 100V amplifier in an Ekinex home automation system

Description	Code
a) Signum virtual button	EK-EV3-TP
b) FF series wall-mount device	EK-ED2-TP
c) Delégo Server	EK-DEL-SRV-BAS-200-TP
d) Sentio App for mobile devices	
e) Delégo 5" panel	EK-DEL-5PAN o EK-DEL-5PAN-P
f) Amazon Alexa - Google Home voice command support	
g) Streamer amplifier 50Wx2	EK-50S-AU
h) 100V external amplifier (not supplied by Ekinex)	EK-T-...
i) T series speakers	EK-T-...
j) Q series speakers	EK-Q-...
k) BUS Power Supply	EK-AB1-TP

Sentio

MULTIROOM AUDIO SYSTEM



A passion for design and music, materials, shapes, acoustic qualities and technology, this is the profile of Sentio. Streamer amplifiers, speakers, subwoofers available in different shapes and colours that can also be customised on request.

The Ekinex multi-room audio system is based on one or more amplifiers that receive the audio stream and transmit it directly to the speakers. Integration modes within the system (near or far from the speakers, playback of TV audio, etc.), single zone or multi-zone mode, and playback of different streaming music sources. Sentio offers easy-to-use audio streaming and speaker solutions with powerful, reliable and easy-to-integrate features. The range of speakers is completed with Ekinex models by Laboratorio Audio, a unique Italian company that has been involved in the high-end audio sector for 20 years.

Laboratorio Audio manufactures all the devices in-house, creating unique objects that will stand the test of time. Selected materials, craftsmanship, maniacal attention to detail, and pushed technology all contribute decisively to the birth of these speakers of pure avant-garde design, passing through an audio revolution to arrive at an absolutely innovative realisation.





Streamer Amplifier 30W

MULTIROOM AUDIO SYSTEM

Description

EK-30S-AU is a Ethernet, WiFi and Bluetooth 5.0 stereo amplifier. Connecting EK-30S-AU to your current home audio system will enable you to stream music from your smart device, USB, NAS or online streaming services such as Spotify and many more using our free to download SENTIO APP, Airplay or DLNA apps. By adding multiple units to your home audio system, you can setup a ethernet or wireless multiroom whole house audio system, it will give you new and great experience to enjoy your favorite music.

Main features

- Streaming music via network without distance limitation or Bluetooth5.0 up to 15 meters.
- Bluetooth for true high resolution music.
- Spotify connect, AirPlay, Qplay, UPnP streaming protocols supported.
- Support streaming source from online services, smart device memory, USB pen drive, NAS, Bluetooth and line in.
- Multiroom and multizone streaming enabled by mutple units connected in same network.
- All music sources can be restreamed in sync to other models from us.
- Airplay, Spotify Connect, Qplay, DLNA, UPnP protocol compatible.
- High quality music streaming support, sample rate decoding up to 24bit, 192kHz.
- Spotify, Tidal, Amazon Music, Tuneln, Internet Radio, lots of online streaming services integrated to use in the app.
- Free iOS and Android app available.
- Free global online update for new features.
- Full function remote controller to use without mobile device. Line input for more possible external audio input.
- EQ adjustment via app or remote controller.
- Preset playlist available for quick access, shortcut buttons on remote controller for quick access.
- iTunes working with PC streaming.

Technical data

- Wireless network: IEEE802.11 b/g/n 2.4G
- Ethernet: Single 10/100M RJ45
- Bluetooth: 5.0
- USB Host: Play USB music
- Micro USB: Connect PC as external DAC
- Power Input: 18V/4A
- Audio Input: 3.5mm Line in
- Frequency response: 20Hz to 20kHz
- Speaker Power: 2x35W@4Ω load at 18V, 2x18W@8Ω load at 18V
- THD+N: 0,03% a 1kHz
- Speaker Impedance: 4-8ohms
- Music Format: FLAC/MP3/AAC/AAC+/ALAC/APE/WAV
- Decoding: Up to 24bit/192kHz
- Protocols: AirPlay, DLNA, UPnP, Spotify Connect
- Dimensions: 131,8 mm*85,5 mm*27 mm (5.18in*3.37in*1.06in)
- Weight: 0,35 kg (0,77 lb)

Delivery

Delivery includes a remote control for controlling the main functions



Order information

Code	Package
EK-30S-AU	1 pcs.



Configuration and commissioning

Installation, electrical connection, configuration and commissioning of the device can only be carried out by qualified personnel. Opening the housing of the device causes the immediate end of the warranty period.



Documentation

For more information see the technical documentation, download from www.ekinex.com



Streamer amplifier 50Wx2

MULTIROOM AUDIO SYSTEM

Description

EK-50S-AU is a WiFi and Bluetooth 5.0 stereo amplifier. Adding EK-50S-AU to your current stereo system will enable you to stream music from your smart device, USB, NAS or streaming services, such as Spotify, Tidal, Deezer, Qobuz, Amazon Music and others by 4STREAM App, AirPlay2, Bluetooth or other DLNA apps. Adding more units to your home audio system can set up a wireless multiroom or multizone whole house audio system, it will give you totally new and great experience to play and enjoy your music.

Main features

- 50Wx2CH@4ohm, 30Wx2CH@8ohm full digital amplifier.
- Streaming music via network without distance limitation or Bluetooth5.0 up to 15 meters.
- Bluetooth for true high resolution music.
- Spotify connect, Tidal connect, Airplay2, Qplay, DLNA, UPnP streaming protocols supported.
- Support streaming audio source from online services, mobile phones & pads, USB disk drive, NAS, Bluetooth, Line input and Optical input.
- Multiroom and multizone streaming enabled by mutple units connected in same network.
- All music sources can be restreamed in sync to other models from us.
- High quality music streaming support, sample rate decoding up to 24bit, 192kHz.
- Sportify, Deezer, Tidal, Qobuz, Amazon Music, Napster, Pandora, Internet Radio, iHeartRadio, Tuneln, QQMusic, lots of online streaming services integrated to use in the app.
- Free iOS and Android app available.
- Free global online update for new features.
- Full functional remote controller to use without mobile devices.
- Line input and Optical input for more external audio input.
- EQ adjustment via app or remote controller.
- Preset playlist is available and short buttons on remote controller for one button play.
- iTunes working with PC streaming.

Technical data

- Wireless network: IEEE802.11 b/g/n 2.4G/5G
- LAN: 10/100M RJ45
- Bluetooth: 5.0
- USB Host: Play USB Music
- USB Type-C: Connect to PC
- Power Input: 24V/4,16A
- Audio Input: Line in (RCA), Optical in, USB Host, USB Type-C (USB DAC)
- Audio Output: Speaker out, Line out (RCA), Subwoofer out (for active subwoofer)
- Speaker Power: 4 ohm 50Wx2 8 ohm 30Wx2
- Speaker Impedance: 4-8 ohm
- Audio Format: MP3/AAC/AAC+/ALAC/APE/WAV/FLAC
- Audio Decoding: Up to 24bit/192KHz
- Dimension: 185 x 155 x 50 mm

Delivery

Delivery includes a remote control for controlling the main functions



Order information

Code	Package
EK-50S-AU	1 pcs.



Configuration and commissioning

Installation, electrical connection, configuration and commissioning of the device can only be carried out by qualified personnel. Opening the housing of the device causes the immediate end of the warranty period.



Documentation

For more information see the technical documentation, download from www.ekinex.com





Streamer amplifier 80Wx2

MULTIROOM AUDIO SYSTEM

Description

EK-80S-AU is a WiFi and Bluetooth 5.0 stereo amplifier. Adding EK-80S-AU to your current stereo system will enable you to stream music from your smart device, USB, NAS or streaming services, such as Spotify, Tidal, Deezer, Qobuz, Amazon Music and others by 4STREAM App, AirPlay2, Bluetooth or other DLNA apps. Adding more units to your home audio system can set up a wireless multiroom or multizone whole house audio system, it will give you totally new and great experience to play and enjoy your music.

Main features

- 80Wx2CH@4ohm, 50Wx2CH@8ohm full digital amplifier.
- Streaming music via network without distance limitation or Bluetooth5.0 up to 15 meters.
- Bluetooth for true high resolution music.
- Spotify connect, Tidal connect, Airplay2, Qplay, DLNA, UPhP streaming protocols supported.
- Support streaming audio source from online services, mobile phones & pads, USB disk drive, NAS, Bluetooth, Line input and Optical input.
- Multiroom and multizone streaming enabled by mutiple units connected in same network.
- All music sources can be restreamed in sync to other models from us.
- High quality music streaming support, sample rate decoding up to 24bit, 192kHz.
- Sportify, Deezer, Tidal, Qobuz, Amazon Music, Napster, Pandora, Internet Radio, iHeartRadio, Tuneln, QQMusic, lots of online streaming services integrated to use in the app.
- Free iOS and Android app available.
- Free global online update for new features.
- Full functional remote controller to use without mobile devices.
- Line input and Optical input for more external audio input.
- EQ adjustment via app or remote controller.
- Preset playlist is avaiible and short buttons on remote controller for one button play.
- iTunes working with PC streaming.

Technical data

- Wireless network: IEEE802.11 b/g/n 2.4G/5G
- LAN: 10/100M RJ45
- Bluetooth: 5.0
- USB Host: Play USB Music
- USB Type-C: Connect to PC
- Power Input: 24V/4,16A
- Audio Input: Line in (RCA), Optical in, USB Host, USB Type-C (USB DAC)
- Audio Output: Speaker out, Line out (RCA), Subwoofer out (for active subwoofer)
- Speaker Power: 4ohm 80Wx2 8ohm 50Wx2
- Speaker Impedance: 4-8 ohm
- Audio Format: MP3/AAC/AAC+/ALAC/APE/WAV/FLAC
- Audio Decoding: Up to 24bit/192KHz
- Dimension: 185 x 155 x 50 mm

Delivery

Delivery includes a remote control for controlling the main functions



Order information

Code	Package
EK-80S-AU	1 pcs.

Configuration and commissioning

Installation, electrical connection, configuration and commissioning of the device can only be carried out by qualified personnel. Opening the housing of the device causes the immediate end of the warranty period.

Documentation

For more information see the technical documentation, download from www.ekinex.com

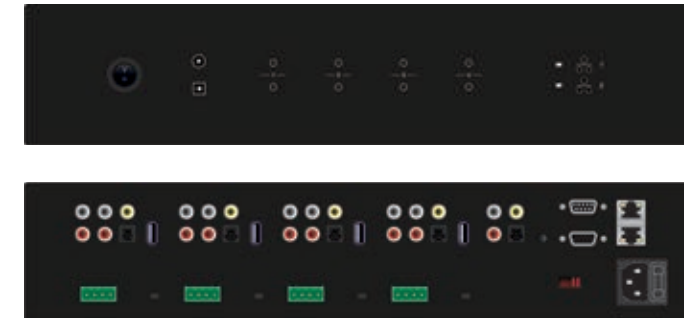

Streaming amplifier 50Wx8

MULTIROOM AUDIO SYSTEM

Description

EK-50Q-AU is a multi-room system that enables you to enjoy your favorite music anywhere in your home. EK-50Q-AU contains 4 audio amplifiers for you to connect to 4 set of stereo speakers. Each zone also contains analogue and digital audio outputs for you to use as audio source. You can easily play music from online music services, your phone storage, NAS and other sources by using the 4Stream app on your iOS or Android device.

Main features

- **Amplification:** Each zone can provide 50Wx2@8ohms (stereo mode) or 100W@4ohms (bridge mode).
- **Multi-room audio function:** Play different songs in different rooms or same song in every room.
- **Easy network setup:** Connect to your home network and it is ready to use.
- **Rich I/O interface:** Each zone has separate digital input/output and analogue input/output. There is also a master source input that all zones can used at the same time.

System Requirements

- **High Speed Internet Connection:** EK-50Q-AU needs internet connection to stream music from online music services and to get online firmware updates. You may experience performance issues with slower internet connections.
- **Wireless Router:** In order to use EK-50Q-AU, you will need to have a working Wi-Fi network in your home, since the control APP on your mobile device need to be in the same network as the streamer.

Delivery

Delivery includes a remote control for controlling the main functions



Order information

Code	Package
EK-50Q-AU	1 pcs.

Configuration and commissioning

Installation, electrical connection, configuration and commissioning of the device can only be carried out by qualified personnel. Opening the housing of the device causes the immediate end of the warranty period.

Documentation

For more information see the technical documentation, download from www.ekinex.com





SENTIO APP CONFIGURATION

Adding devices
The Sentio app allows new audio zones to be added to the system very easily, through a wizard accessible directly from the main screen.

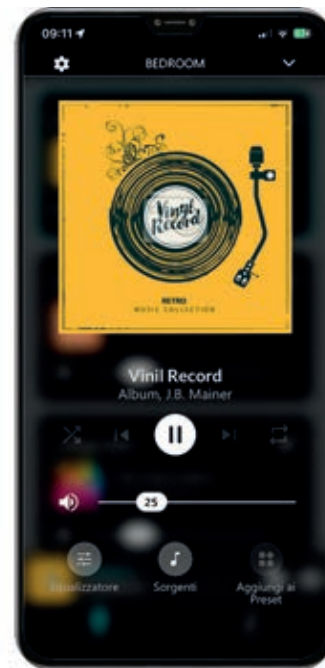

SENTIO APP CONFIGURATION

Zone player
By pressing on the name of a zone, in addition to the basic controls already available on the main screen, it is possible to have full control over playback, switching to the next track, or adjusting the scrolling mode between the contents of the current playlist (random play or repeat).

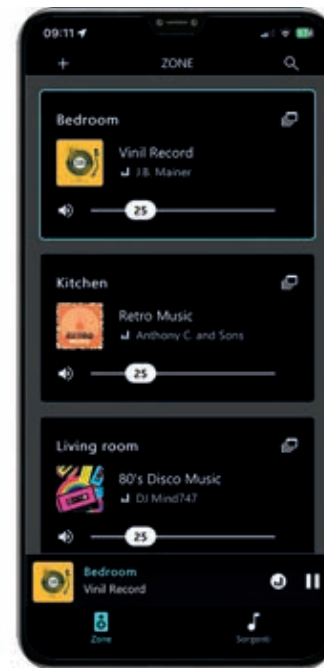

SENTIO APP CONFIGURATION

Zone management
The app's main screen allows you to control all the zones of the sound system at a glance. By selecting a zone, you can know what content is playing, adjust the volume, and easily control playback.

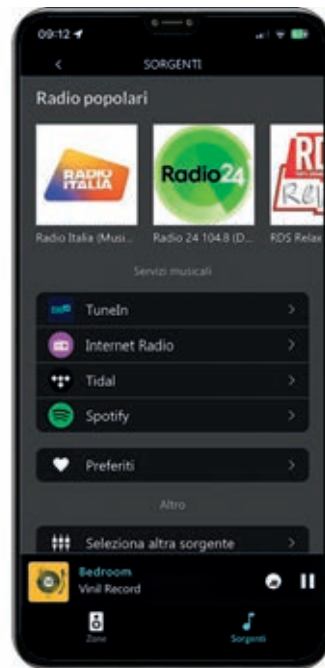

SENTIO APP CONFIGURATION

Source selection
It is possible at any time to quickly change the music source for a zone, or a group of zones, by pressing the SOURCE symbol in the toolbar at the bottom. Music can be played from a local source connected to the device, or from a streaming service accessible via a Wi-Fi network.

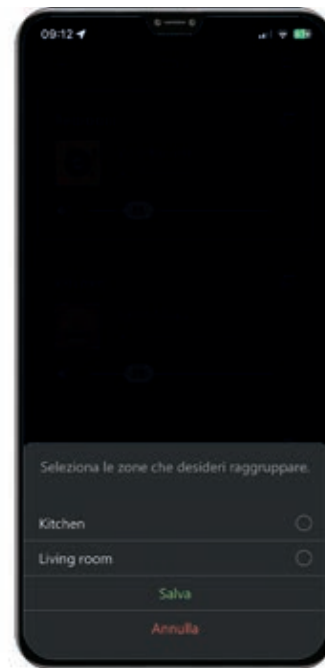

SENTIO APP CONFIGURATION

Zone groupship
By pressing the grouping symbol on a zone, you can easily connect other devices to play the same music source simultaneously in several rooms. By repeating the same operation, it is possible to change the composition of the zone group, or return to independent operation of each device.

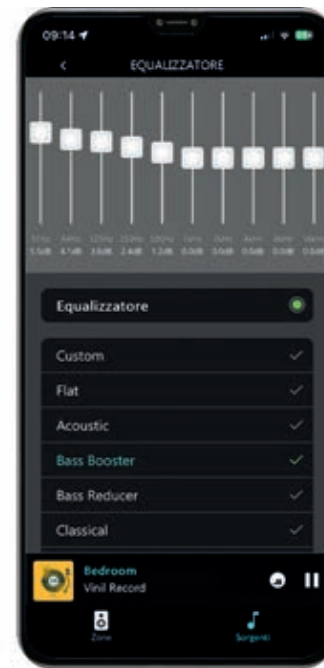

SENTIO APP CONFIGURATION

Equaliser
The Equaliser screen allows you to adjust the amplitude of the different sound frequencies in an audio signal. It is possible to modify the frequency response of an audio system to suit the listener's preferences or the acoustic characteristics of the room.



Wall-mounted speaker IP66 (pair)- black/white
MULTIROOM AUDIO SYSTEM

Description

The Ekinex Home Audio Speaker EK-SP30.2-AU offers a unique combination of sleek ascetic design and high performance sound quality, Its small footprint allows for easy system integration without compromising on sound quality or performance IP66 Weather Resistant rating allows for Indoor/Outdoor applications making it one of the most versatile Home/Commercial Audio speakers available.

Main features

- When the speakers are installed on the walls, ensure the wall structure is reliable and that the speakers are firmly attached.
- Install the speaker in a location that can structurally support the weight of the speaker and its mounting hardware. otherwise it may result in the unit falling down and causing personal injury.
- Do not use nails, adhesives or other unauthorized devices long-term use and vibrations may cause it to fall easily.
- Do not touch or bump the woofer and tweeter. If these are damaged, the sound will be distorted.
- Lower the volume of the device and source unit when changing the input source. (i.e. To tune fm / cd).
- Turn off the device and source unit when installing or removing cables.

Specifications

- Recommended amplification: 40 Watts
- Frequency response: 120Hz - 20KHz
- SPL 1W/1m: 88 dB
- Impedance: 8 ohm
- Frequency range: Extended
- Woofer: 2.5" (64mm)
- Woofer cone material: Paper
- Grille material: Fabric
- Dispersion angle: 120°
- Mounting system: Rotation/tilt bracket (included)
- Housing material: Reinforced ABS plastic
- IP weather rating: IP66
- Height: 94 mm
- Depth: 108 mm
- Width: 82 mm
- Product net weight (kg): 0,48
- Colour: RAL9011 (BL)

FRAME FINISHES



FABRIC FINISHES



Order information

Code	Colour	Pack
EK-SP30B2-AU	BLACK (RAL9011)	2 pcs.
EK-SP30W2-AU	WHITE (RAL9016)	2 pcs.

Documentation

For more information see the technical documentation, download from www.ekinex.com



EK-SP30B2-AU EK-SP30W2-AU



2-way full-range in-ceiling speaker

MULTIROOM AUDIO SYSTEM

Description

The EK-SP525-AU Loudspeaker offers excellent sound quality with transparent highs, clear and clean vocals, and deep bass. It is also very easy to install, ideal for commercial use and home theater systems.

Main features

- Recommended amplification: 60 Watts
- Frequency Response: 70Hz - 20KHz
- SPL 1W/1m: 89 dB
- Impedance: 8 ohm
- Frequency range: Extended
- Tweeter: Orientable 1.5" aluminium
- Woofer: 5.25" Glass Fibre Adjustable
- Woofer cone material: Glass Fibre
- Grille material: Paintable Metal
- Dispersion angle: 120°
- Mounting system: Plasterboard Recessed
- Grille diameter: 205 mm
- Hole diameter: 175 mm
- Depth: 110 mm
- Colour: RAL9016 (W)

FABRIC FINISHES

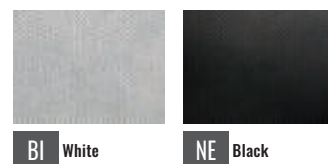

Order information

Code	Pack
EK-SP525-AU	1 pcs.



Documentation
For more information see the technical documentation, download from www.ekinex.com



Speaker Q series

MULTIROOM AUDIO SYSTEM
Ekinex by laboratorioaudio

Description

Small, modern, minimalist, with acoustic and technological content of high quality. A nice project.

Q10

Wall version or in-wall version, Q10 is the smallest speaker manufactured. This is not a reason to underestimate it, and in fact it boasts a warm compact sound. It suits a variety of uses both outdoor and indoor.

Q15

Almost invisible, Q15 can be in-wall, book-shelves/to be leant, or on wall. The aesthetic result meets the expectations of the most rigorous needs. Sound and design are the best marks of this small objet, bringing sound to any rooms without being noticed, but it can involve the listeners so much.

Q20

Q20 has been designed to be used in every type of furniture and environment, it can be wall, book-shelves, or to be leant version, or bipolar "flag mode" version, suitable to sound offices, museums, bars, etc.

Purist design, very good minimalist finishing (polished or anodized aluminium, bright black or bright white painted).

Prefix	Series	Installation	Variant				Frame Colour				Fabric Colour			Description	Dimension WxHxD (mm)	
			HT	ST	R	100V	LN	LB	ASA	ASN	BI	NE	SA			
EK	Q10	CG	Plasterboard	-	-	-	-	-	-	-	-	•	•	•	Plasterboard built-in Speaker, 50W, 80-16KHz	100x100x53
		CG	Plasterboard	•	•	•	•	-	-	-	-	•	•	•	Plasterboard built-in speaker, 50W, 60-21KHz	150x150x70
	Q15	M	Masonry	•	•	•	•	-	-	-	-	•	•	•	Masonry built-in speaker, 50W, 65-20KHz	150x150x70
		W	Wall	-	-	-	-	•	•	•	•	•	•	•	Wall mount speaker, 50W, 60-21KHz	150x150x70
		K	Surface	-	-	-	-	•	•	•	•	•	•	•	Surface mount speaker, 50W, 50-21KHz	150x150x74
Q20	W	Wall	-	-	-	-	•	•	•	•	•	•	•	Wall mount speaker, 65W, 50-21KHz	200x200x61	
	K	Surface	-	-	-	-	•	•	•	•	•	•	•	Surface mount speaker, 65W, 50-21KHz	200x200x61	

(HT) High performance version - (ST) Stereo version - (R) Lowered version - (100V) 100V transformer version

FRAME FINISHES

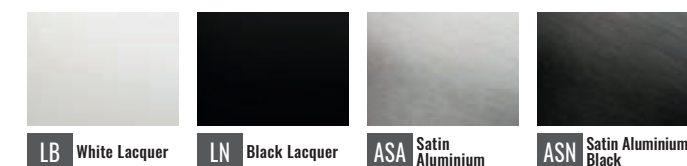

Encoding example

EK	Q15	W	LB	BI
Prefix	Series	Installation	Frame Colour	Fabric Colour

FABRIC FINISHES



Documentation
For more information see the technical documentation, download from www.ekinex.com





Speaker R series

MULTIROOM AUDIO SYSTEM
Ekinex by laboratorioaudio

Description

To relive the fantastic design of the '60s with contemporary technological solutions. Deriving from the consolidated series Q20, it differs from it having softer lines with rounded edges, reminding of the beautiful '60s, while maintaining excellent performance. Available in the same finishings as the Q20. Series R20K: designed to impress and satisfy an expert audience, using advanced technology, with a refined and sober design. They reproduce the entire audio range, up to lower frequencies, with a soundstage and a deep sound image without compromises.

Prefix	Series	Installation	Frame Colour				Fabric Colour		Description	Dimension WxHxD (mm)	
			LN	LB	ASA	ASN	BI	NE			
EK	R20	W	Wall	•	•	•	•	•	•	Wall mount speaker, 65W, 50-21KHz	200x200x65
		K	Surface	•	•	•	•	•	•	Surface mount speaker, 80W, 45-21KHz	200x200x200

FRAME FINISHES



FABRIC FINISHES



Encoding example

EK	R20	K	LB	BI
Prefix	Series	Installation	Frame Colour	Fabric Colour



Documentation
For more information see the technical documentation, download from www.ekinex.com



Speaker T series

MULTIROOM AUDIO SYSTEM
Ekinex by laboratorioaudio

Description

Designed in various versions, to meet the need for soundproofing rooms from the ceiling while maintaining a remarkable aesthetic cleanliness. Minimalist in appearance but geBlackus in sound, the T13 in models 13, 13S is made in satin and mirror polished aluminium, or in lacquered finishes. It is also available in a wall-mounted version in model T18CG for plasterboard.

Prefix	Series	Installation	Variant	Frame Colour			Fabric Colour			Description	Dimension ØxP (mm)
				100V	LB	LA	ASA	BI	NE		
EK	T13	W	Wall	•	•	•	•	•	-	Wall/Ceiling mount speaker, 50W, 80-20KHz	130x132
	T13S	W	Wall	-	•	•	•	•	-	Wall/Ceiling mount speaker, 50W, 80-20KHz	130x89
	T18	CG	Plasterboard	•	-	-	-	•	•	•	Plasterboard built-in speaker, 50W, 60-21KHz

(100V) 100V transformer version

FRAME FINISHES

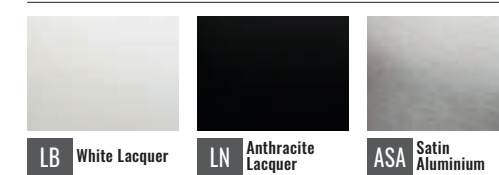

FABRIC FINISHES



Encoding example

EK	T13	W	LB	BI
Prefix	Series	Installation	Frame Colour	Fabric Colour



Documentation
For more information see the technical documentation, download from www.ekinex.com





Speaker Omni/Iride

MULTIROOM AUDIO SYSTEM
Ekinex by laboratorioaudio

Description

Original and efficacious, it reproduces high quality sound all around at 360°. It has different fixing solutions basing on where it is used, indoor or outdoor. Outside it can voice a circular area with minimum radius of about 10mt, in normal conditions, and in the version IRIDE, it is equipped with a LED lighting device. Designed by Claudio Niorettini, it is available in RAL colours or polished aluminium.

Prefix	Series	Installation	Variant	Frame Colour			Description	Dimension ØxH (mm)
				100V	LB	LA		
EK	OMNI	K	Masonry	•	•	•	Surface mount speaker, 75W, 55-20KHz	130x1000
	IRIDE	K	Masonry	•	•	•	Surface mount speaker + LED lighting, 75W, 55-20KHz	130x1000

(100V) 100V transformer version

FRAME FINISHES



Encoding example

EK	OMNI	K	LB
Prefix	Series	Installation	Frame Colour



Documentation

For more information see the technical documentation, download from www.ekinex.com



Description

Small, compact, simply minimal, these are our instruments to reproduce the lowest frequencies. They can sound great environment, thanks to their double volume tuned system and passive radiators, and can reach great acoustic volumes, by articulating to the lowest octaves of the audio range.

Prefix	Series	Installation	Frame Colour		Fabric Colour		Description	Dimension WxHxD (mm)	
			LN	LB	BI	NE			
EK	K27SUB	K	Surface	•	•	-	-	Amplified floor-standing subwoofer 150W, 38-100Hz	270x270x290
	K35SUB	K	Surface	•	•	-	-	Amplified floor-standing subwoofer 150W, 28-100Hz	350x350x370
	Q5.5SUB	M	Masonry	-	-	•	•	Built-in subwoofer (brick), passive, 100W, 40-150Hz	303x303x125
	Q6.6SUB	M	Masonry	-	-	•	•	Built-in subwoofer (brick), passive, 130W, 35-120Hz	303x303x125

FRAME FINISHES

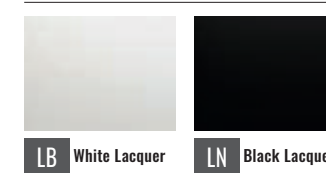

Encoding example

EK	K27SUB	K	LB
Prefix	Series	Installation	Frame Colour

FABRIC FINISHES

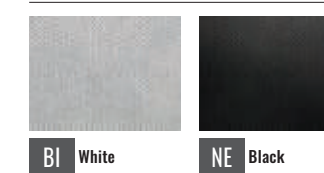

Documentation

For more information see the technical documentation, download from www.ekinex.com



Sub

MULTIROOM AUDIO SYSTEM
Ekinex by laboratorioaudio

Speaker Modulor

MULTIROOM AUDIO SYSTEM
Ekinex by Laboratorioaudio



Description

The Modulor line comprises floor-standing or wall-mounted speakers with a minimalist design. Streamlined and meticulously detailed, they are available in 105 cm, 80 cm and 65 cm modules, lacquered only 6.6 cm thick and 15 cm wide. Laboratorio Audio's Modulor speakers offer a stage reconstruction that is absolutely faithful to the musical recording, with a level of sound reproduction of the highest order that is able to give emotions equal to those of live performances. Modulor speakers are also available in three-channel and subwoofer versions in various sizes and can be customised in any RAL colour on request.

Code	Numbers of ways	Rated power (W)	Frequency (Hz)	Sensitivity (dB)	Colour		Description	Dimension WxHxD (mm)
					LN	LB		
EK-M35W-..	2	65W	70-21KHZ	87 dB	•	•	2-way wall-mount speaker	150x350x66
EK-M65W-..	2	125W	50-21KHZ	88 dB	•	•	2-way wall-mount speaker	150x650x66
EK-M105W-..	2	125W	40-21KHZ	88 dB	•	•	2-way wall-mount speaker	150x1050x66
EK-M123W-..	2	125W	40-21KHZ	88 dB	•	•	2-way wall-mount speaker	150x1230x66
EK-M145W-..	2	125W	40-21KHZ	88 dB	•	•	2-way wall-mount speaker	150x1450x66
EK-M65W-ST-..	2 x 2 canali	125W x 2	50-21KHZ	88 dB	•	•	2-way wall-mount speaker for 2 stereo channels	150x650x66
EK-M105W-ST-..	2 x 2 canali	125W x 2	40-21KHZ	88 dB	•	•	2-way wall-mount speaker for 2 stereo channels	150x1050x66
EK-M123W-ST-..	2 x 2 canali	125W x 2	40-21KHZ	88 dB	•	•	2-way wall-mount speaker for 2 stereo channels	150x1230x66
EK-M145W-ST-..	2 x 2 canali	125W x 2	40-21KHZ	88 dB	•	•	2-way wall-mount speaker for 2 stereo channels	150x1450x66
EK-M105W-TRI-..	2 x 3 canali	125W x 3	40-21KHZ	88 dB	•	•	2-way wall-mount speaker for 3 channels	150x1050x66
EK-M123W-TRI-..	2 x 3 canali	125W x 3	40-21KHZ	88 dB	•	•	2-way wall-mount speaker for 3 channels	150x1230x66
EK-M145W-TRI-..	2 x 3 canali	125W x 3	40-21KHZ	88 dB	•	•	2-way wall-mount speaker for 3 channels	150x1450x66
EK-M160W-TRI-..	2 x 3 canali	125W x 3	40-21KHZ	88 dB	•	•	2-way wall-mount speaker for 3 channels	150x1600x66
EK-M172W-TRI-..	2 x 3 canali	125W x 3	40-21KHZ	88 dB	•	•	2-way wall-mount speaker for 3 channels	150x1720x66
EK-M105W-SUB-..	1 subwoofer	100W	40-200HZ	87 dB	•	•	Passive subwoofer	150x1050x66
EK-M123W-SUB-..	1 subwoofer	100W	40-200HZ	87 dB	•	•	Passive subwoofer	150x1230x66

FRAME FINISHES

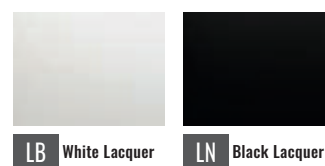

Documentation

For more information see the technical documentation, download from www.ekinex.com



KNX-Sentio Gateway

MULTIROOM AUDIO SYSTEM

Description

The KNX-Sentio Gateway allows one or more multi-room audio devices from the SENTIO range to be integrated with KNX technology, acting as an interface to other KNX devices. The KNX-Sentio Gateway automatically detects the zones of the audio system in the network, and allows for each of them, a set of KNX group addresses to receive status information on the bus and send the following commands:

Main features

- Volume adjustment (both via percentage and increase/decrease commands)
- Highs and lows (both via percentage and increase/decrease commands)
- Play/Pause
- Mute
- Previous/next track advancement
- Setting Repeat and/or Random Play
- Preset / source selection (either by direct selection or by previous / next scrolling)

Information about the artist and the track being played is also sent on the KNX bus. The KNX-Sentio Gateway is particularly suitable for operating the Sentio system from Signum control panels, via their audio control page.

Technical data

- 12-24 Vdc power supply (absorption 240 mA at 12 Vdc) by means of a special plug-in terminal supplied. Power supply not included
- KNX TP bus (twisted pair) via red-black terminal provided
- 1 Ethernet port via cat. 5 or higher cable and standard RJ45 connector
- 2 frontal LEDs: POWER LED for signalling the presence of power supply; SERVICE LED for signalling particular operations in progress.
- 1 RESET button housed under the front cover on the back of the vertical card
- 1 RS485 port: not used
- 1 USB 2.0 port: not used

Dimensions [mm]

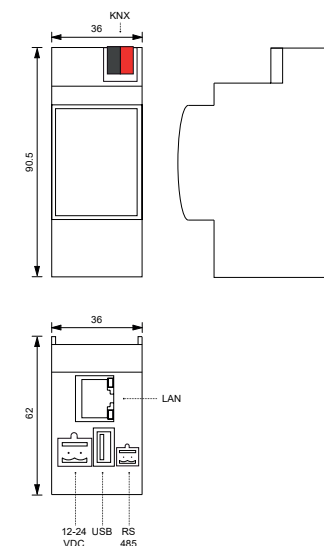

Order information

Code	Application	Package
EK-BR1-TP	KNX Integration and Sentio Multiroom Audio System	1 pcs.



Documentation

For more information see the technical documentation, download from www.ekinex.com





IP DOOR PHONE

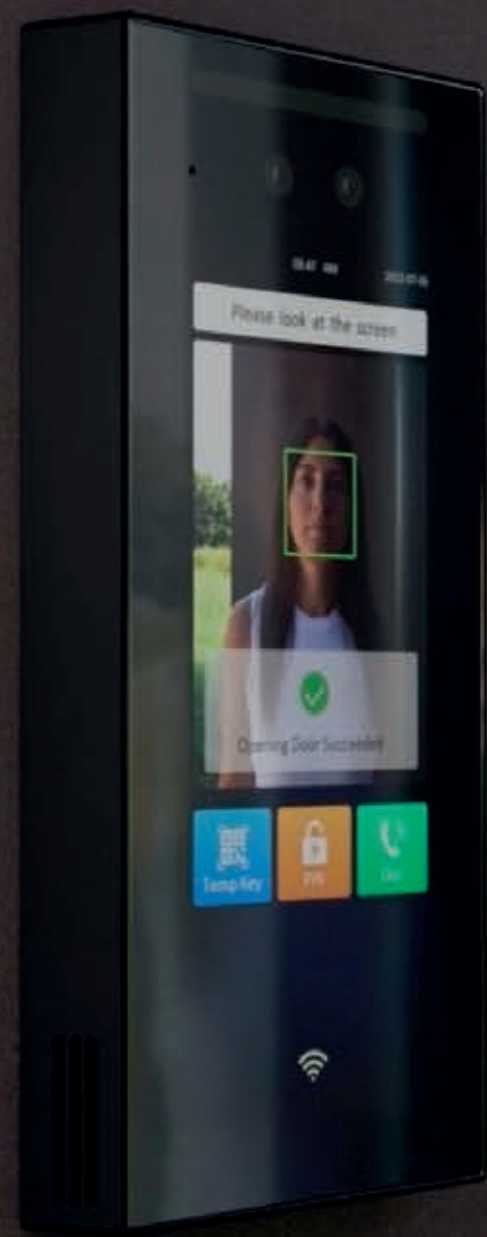



Dico
IP DOOR PHONE

With a sleek design and extreme ease of use, the Dico IP Door phone leverages a wide range of cutting-edge technologies for intelligent building access and home control.

Product range



IP Door phone

Flush-mounted box (120x230x3 mm) and frame (on request)

Flush-mounted box (130x310x8 mm) and frame (on request)

Rain cover (on request)

IP DOOR PHONE CONNECTION SCHEME

- KNX
- LAN
- - - Other connection

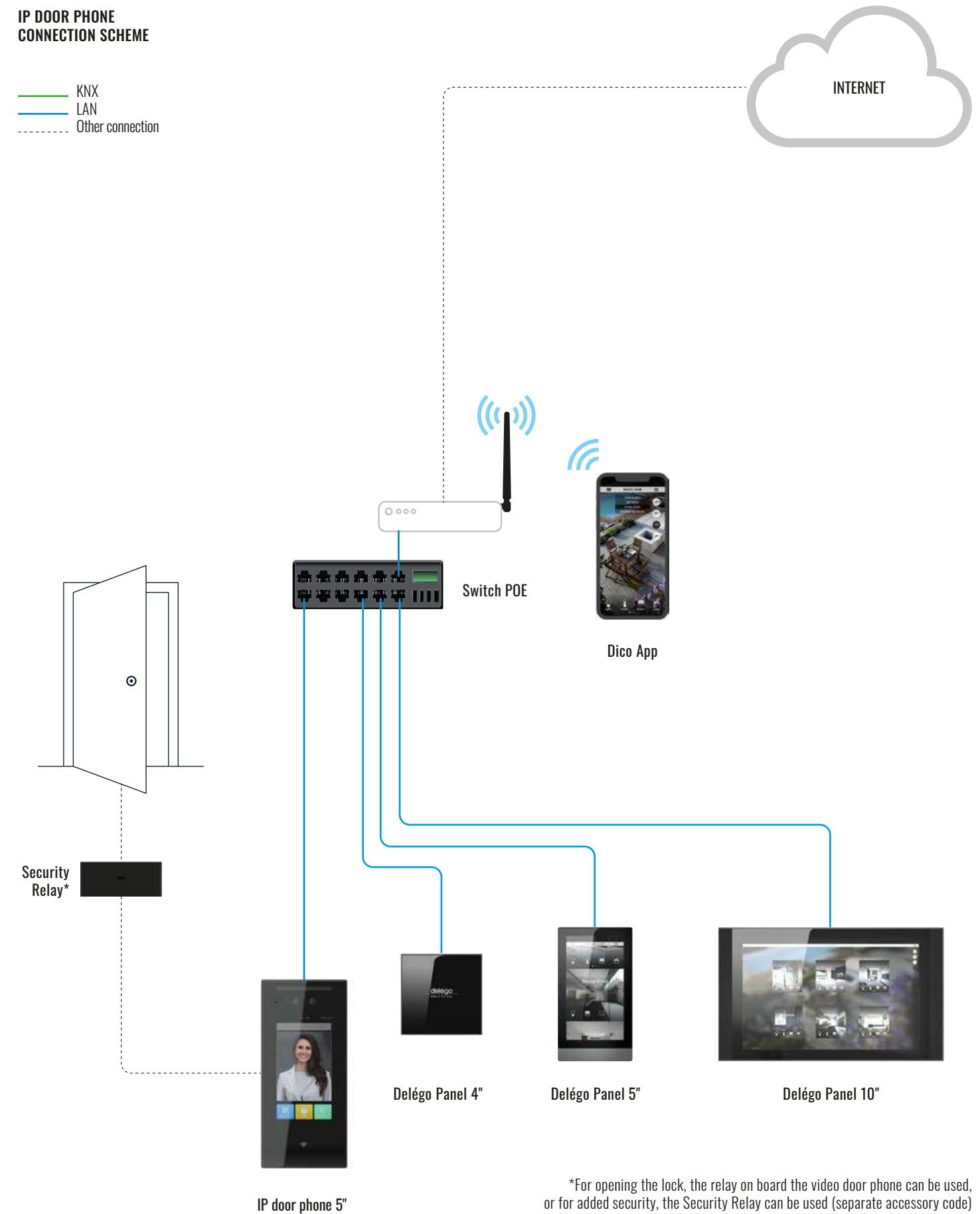

*For opening the lock, the relay on board the video door phone can be used, or for added security, the Security Relay can be used (separate accessory code)

IP DOOR PHONE CONNECTION SCHEME WITH KNX AND DELÉGO (OPTION 1)

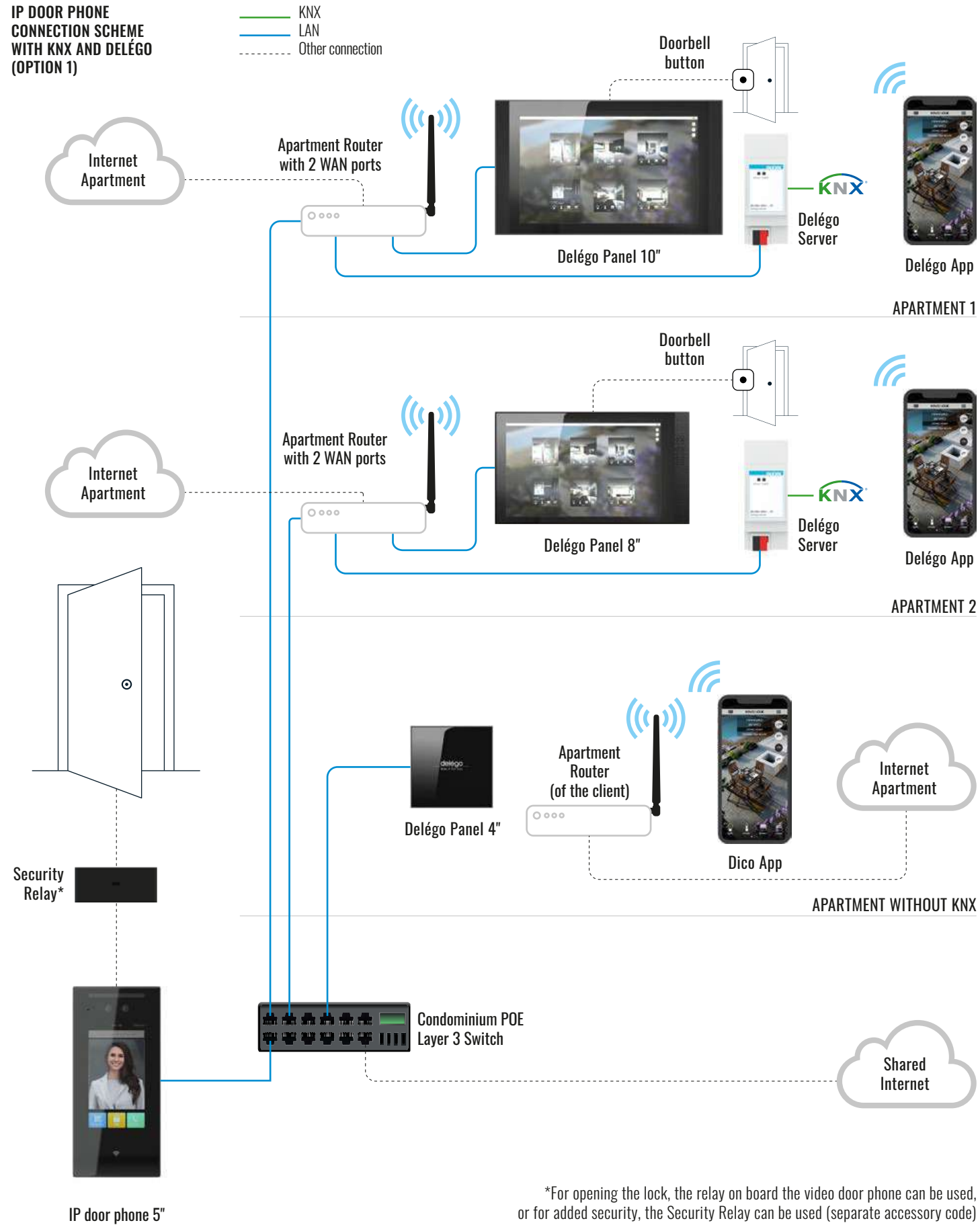

*For opening the lock, the relay on board the video door phone can be used, or for added security, the Security Relay can be used (separate accessory code)

IP DOOR PHONE CONNECTION SCHEME WITH KNX AND DELÉGO (OPTION 2)

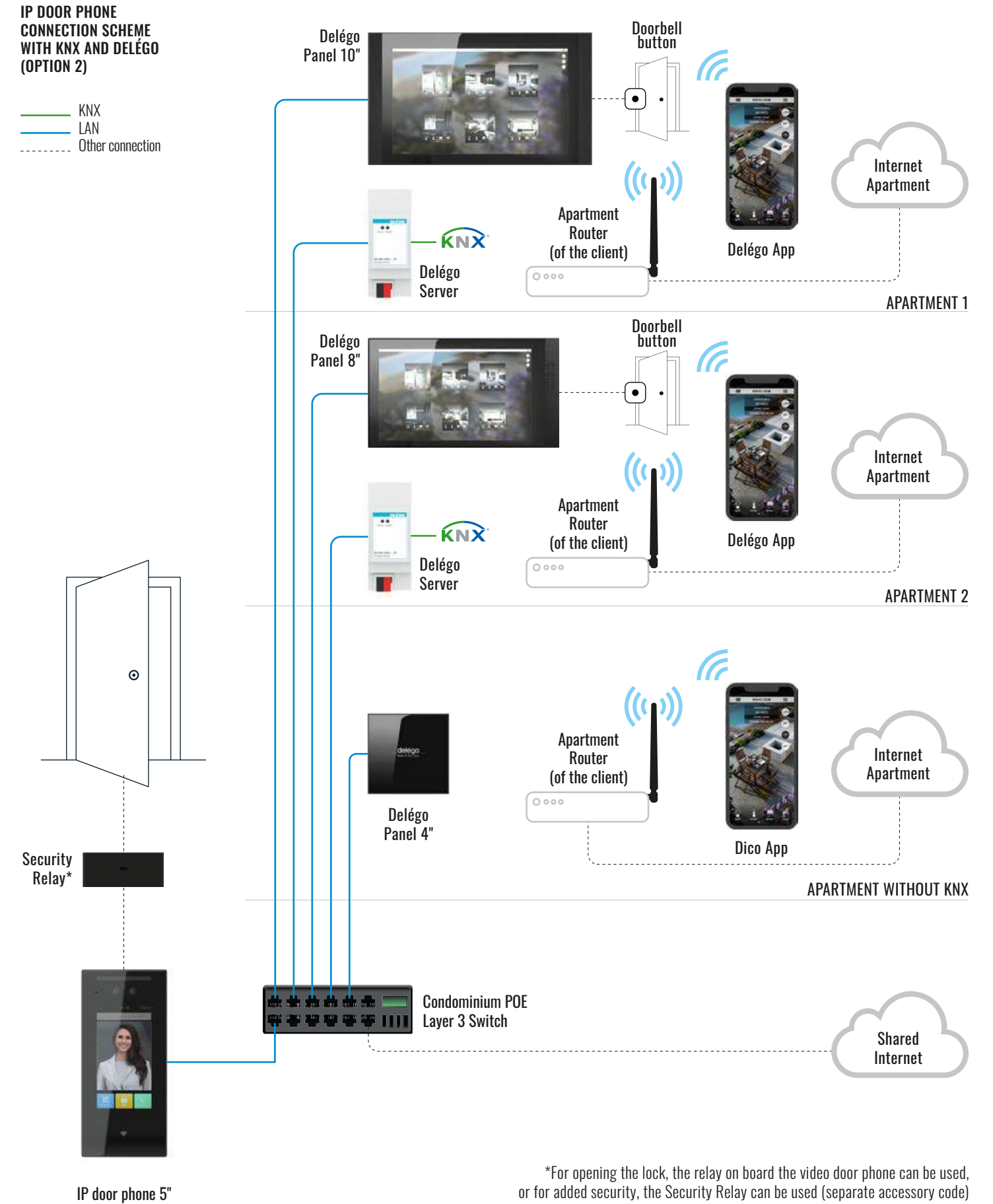

*For opening the lock, the relay on board the video door phone can be used, or for added security, the Security Relay can be used (separate accessory code)



MULTIPLE ACCESS CONTROL MANAGEMENT

Facial Recognition

DICO integrates a powerful facial recognition system, based on biometric data stored within the device (no cloud calls). Biometric profiles are anonymised in full compliance with privacy and GDPR directives. Faces can be stored by uploading a simple photo to the local configuration web interface, or through a learning procedure.

When a face is recognised, DICO can close its integrated relay, and also send a request to Delégo to perform other operations such as KNX auxiliary commands or scenarios.



MULTIPLE ACCESS CONTROL MANAGEMENT

QR code reading

DICO can also enable access via a previously generated and authorised QR code. In this way, it is possible to conveniently grant access for a certain period to occasional guests, without the need to store their biometric data and/or share their code numbers.



MULTIPLE ACCESS CONTROL MANAGEMENT

Virtual Keyboard

DICO allows access to controlled accesses by entering a numerical PIN code, directly on the display. In the future, it may be integrated into the MyWay access control system on Delégo.

MULTIPLE ACCESS CONTROL MANAGEMENT

Multi-apartment and multi-tenant management

The Dico video door entry system lends itself perfectly to multi-apartment residential building management, even of large size, as well as tertiary and multi-tenant installations. The graphic interface can be customised to display:

The direct list of tenants (in flat mode), typically used in apartment buildings. The list of companies, with a sub-page dedicated to the interiors of each company, typically used in multi-tenant buildings.

The optional screen saver mode can display e.g. a static logo, individual company logos in rotation, or the building address.



MULTIPLE ACCESS CONTROL MANAGEMENT

NFC technology

DICO can also enable access via RFID cards or 13.56 MHz proximity cards. In the future, this function may be integrated into the MyWay access control system on Delégo.

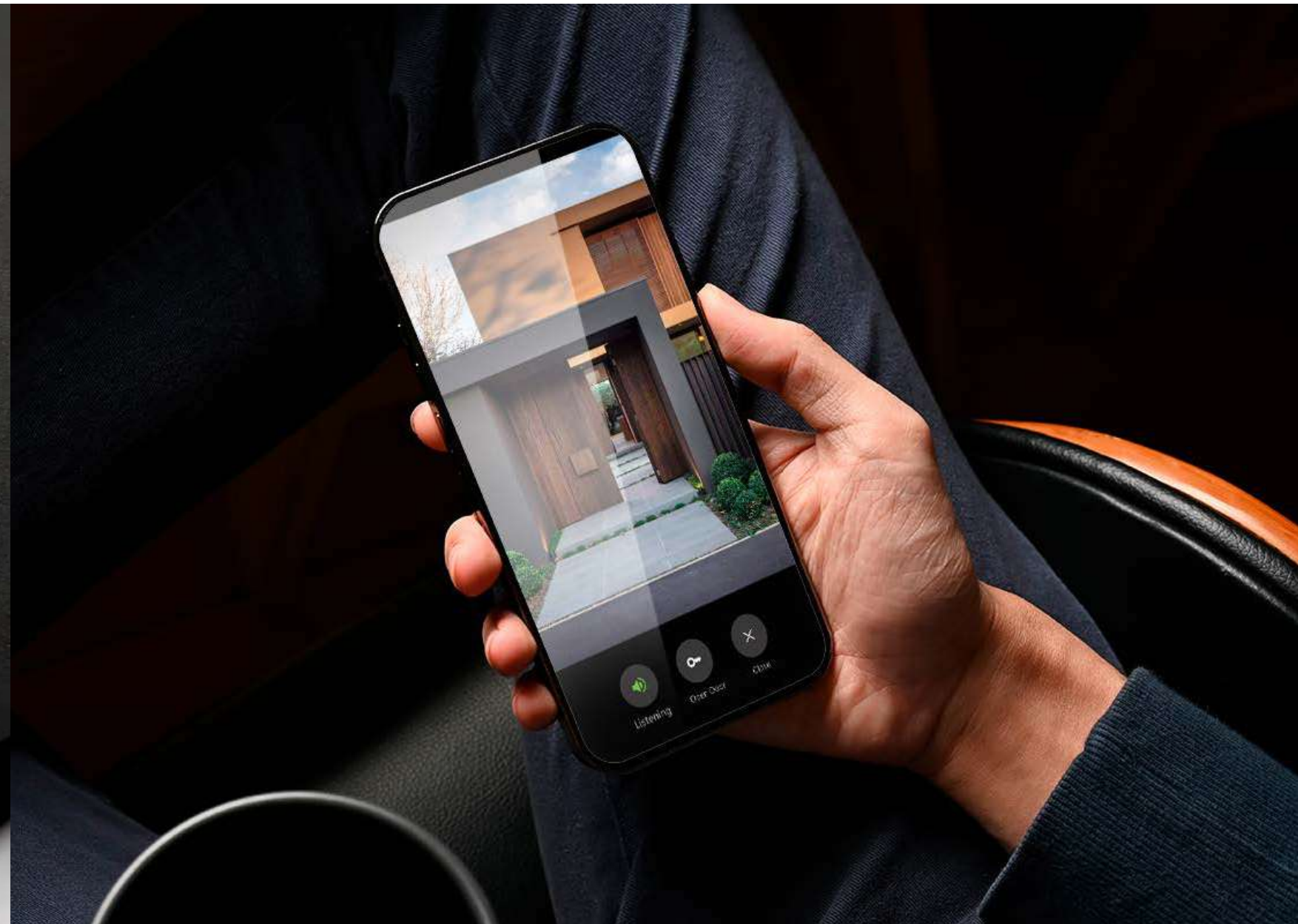

MULTIPLE ACCESS CONTROL MANAGEMENT

Using via App

The DICO app can be used both by installers, to configure a system equipped with one or more video door phones and to establish the rules for forwarding calls to the different flats, and by end users, to receive calls when they are not inside the building, and to monitor their video door phones remotely, including consulting the call and access history.

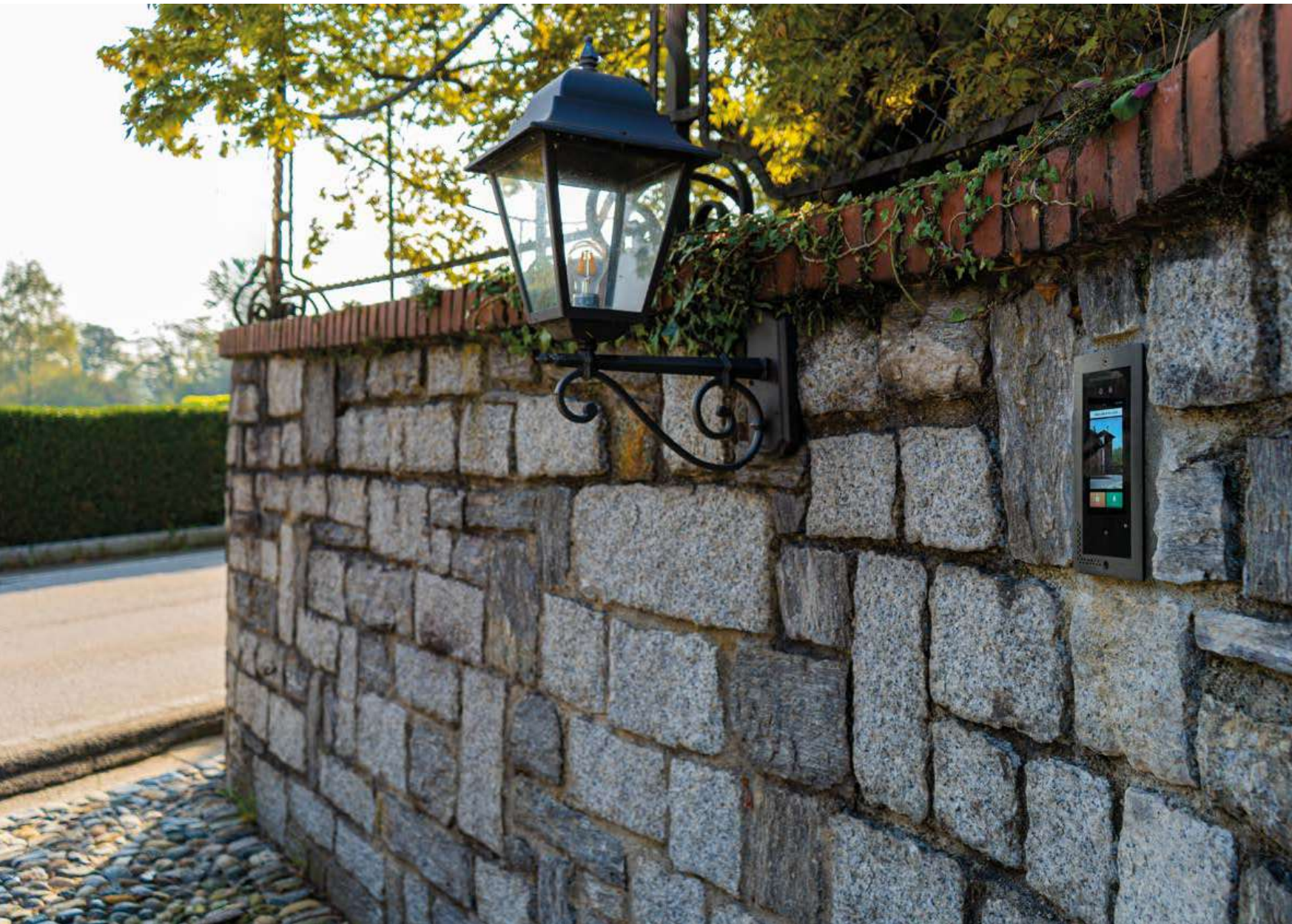

Dico IP DOOR PHONE

The Dico IP door phone is a secure and affordable commercial-grade device for both intercom and for access control.

Dico is an IP outdoor door phone based on the SIP standard, which is fully integrated with the Delégo supervision system and can operate completely autonomously within the customer's home network. It is a fully touch product, with no physical buttons, and thanks to integration with the Ekinex cloud and the Delégo app, it is possible to receive video calls wherever you are (feature available in Q1 2024).

Many functions in one device: Dico is not just a simple video IP Door phone. It manages a multiple access control system through facial recognition, virtual keypad, QR code reading, and NFC technology. The innovative touch screen compared to market standards (physical pushbuttons) also allows for extremely high configuration flexibility and can be wall-mounted or flush-mounted using the special cover with mounting box.

With the latest deep learning algorithm and dual camera motion detection technology, EK-5DP-VI can be used for residential and commercial applications to realize intelligent access control.



Dico IP DOOR PHONE

Description

IP Door phone offering excellent intercom-type communication and flexible access control methods such as facial recognition based on artificial intelligence and controllable by the mobile app. It can be used in commercial and community applications to implement smart, fast, secure and reliable access control by integrating with various third-party devices such as attendance and visitor management systems.

Technical data

- 5" IPS LCD touch screen display
- 1280 x 720 pixel resolution
- 2M pixel dual-lens camera, WDR
- Input/output relays: 1 / 1
- Ethernet port RJ45, 10/100Mbps adaptive
- Power Supply 802.3af Power-over-Ethernet
- 12 Vdc power supply (if not using PoE)
- Max. current consumption 380 mA
- Tamper (tamper) supported

Recommended cable length depending on section for installation with 12V - 1.5 A power supply:

- ≤ 30m for section 20 AWG
- ≤ 20m for section 22 AWG
- ≤ 15m for section 23 AWG

Recommended cable length depending on section for installation with 12V - 1.0 A power supply:

- ≤ 20m for section 20 AWG
- ≤ 10m for section 22 AWG

Environmental operating conditions:

Wall-mounted or recessed installation with optional box and frame EK-5IW-VI available for purchase from Ekinex. EK-5SRC-VI rain cover available upon request.

Functions / Features

- Protection IP65
- Relative humidity of the installation environment: 10-90% non-condensing
- Operating temperature: -20°C to +55°C
- Dimensions (WxHxD): 192 x 88 x 27,5 mm
- Weight (assembled product): 600 g
- Flexible authentication: mobile app, facial recognition, NFC, QR codes, PIN codes, IC card (contactless smart card)
- 1 output relay for door opener
- Visible light facial recognition
- Dual cameras with anti-spoofing algorithm against photo and video forgery
- Storage of up to 20.000 images and 20.000 cards
- Facial recognition speed of less than 0,2 seconds/user
- Facial recognition accuracy rate of more than 99,7%
- Allows audio and video communication with an IP phone, Delégo App or Delégo Panel
- Multiple verification methods including: face, PIN, NFC, RFID cards and QR codes
- Configuration via web browser
- Touch screen user interface with simplified navigation
- Excellent voice intelligibility in any situation, even noisy ones
- Easy installation requiring only power, internet and door opener
- Space-saving 5" design perfect for narrow door frames

Dimensions [mm]

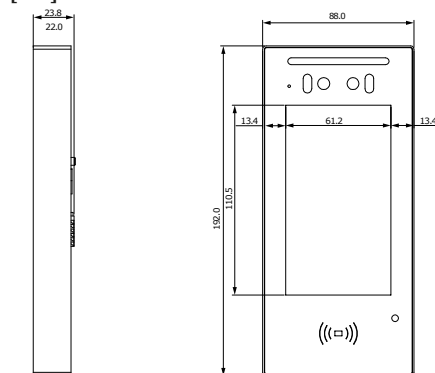

Order information

Code	Use	Packaging
EK-5DP-VI	IP Door phone 5"	
EK-5IW-VI	Box and frame for flush mounting	1 pcs.
EK-5SRC-VI	Rain cover	



Documentation

For more information see the technical documentation, download from www.ekinex.com





Dico Security Relay

IP DOOR PHONE

Description

The Dico Security Relay provides secure door control via encrypted communication when combined with other Ekinex devices. The module with ultra-compact form, easily placed in most standard installation boxes, is installed on the secure side of the door. If anyone attempts to dismount or vandalize the station, SR1 cuts the connection to the door strike and the door remains securely locked.

Functions / Features

- Environment: Indoor
- Casing: Plastic
- Dimensions: 31x56x24mm
- Mounting: Fits in standard installation boxes
- Working Humidity: 10 - 90%
- Working Temperature: 20°C - +60°C
- Relay Out: 1
- RS485: 1
- Input: 1
- Button: 1, for pairing
- Indicator: 2
- Power In: 1,12V/100mA (Min.)

Dimensions [mm]

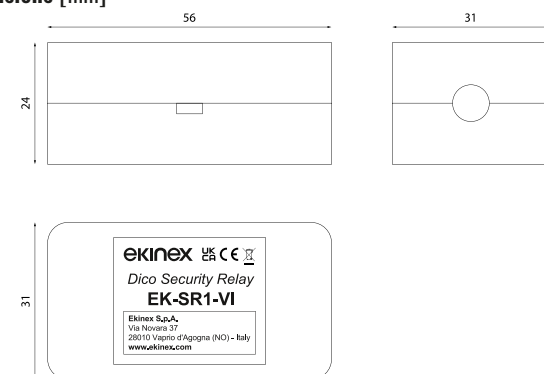

Order information

Code	Use	Packaging
EK-SR1-VI	Controllo sicuro della porta tramite comunicazione criptata se abbinato ad altri dispositivi Ekinex	1 pcs.



Documentation

For more information see the technical documentation, download from www.ekinex.com





.....
LIFT TV
.....

Under Bed Lift TV	384
Up & Down Lift TV	385





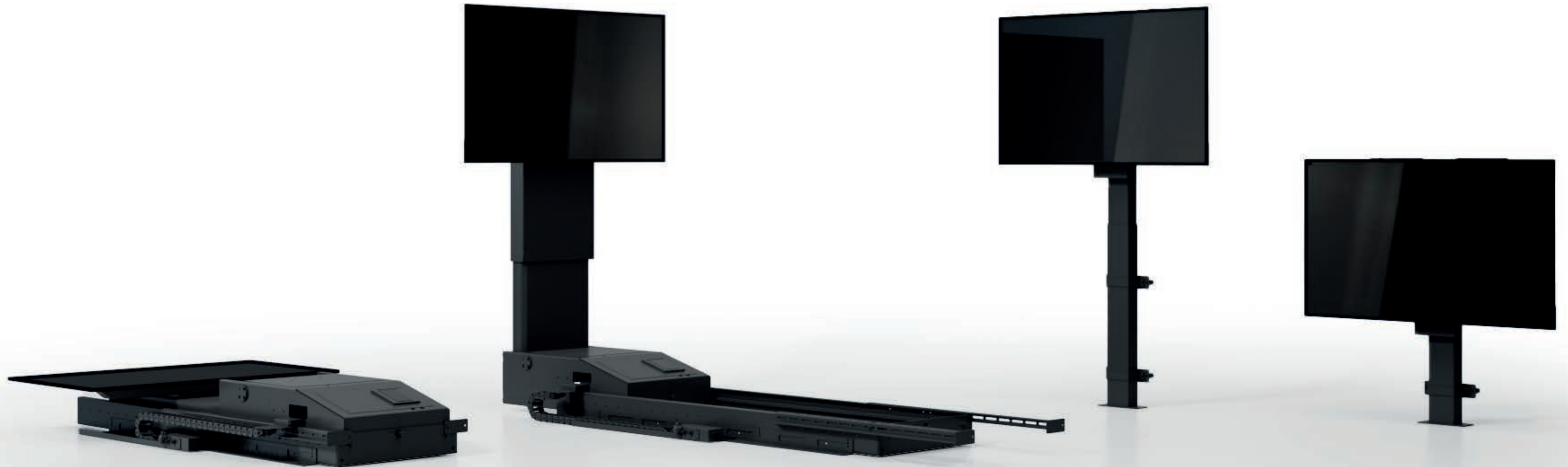

Revélo

LIFT TV

We love to watch our favourite series, sporting events, the news as soon as we wake up, but we only want to see TV when needed. That is why we have created a series of Made in Italy lifts that help you to better arrange your space, giving you the opportunity to hide the TV when it is not in use.

Product range

Revélo
Lift TV



Under Bed Lift TV

Up & Down Lift TV

Up & Down Lift TV - XL



Revélo

LIFT TV



Would you hide a beautiful view to make room for a TV? The room gains in space, usability and order, and you don't miss out on the view of your favourite scenery.

The need for better space management, combined with the minimalist design of a certain type of furniture, are two aspects that cannot be overlooked. The presence of elements such as TVs or monitors can be intrusive within a room. This gives rise to the need to conceal these devices when they are not in use.

Under Bed Lift TV. In your room, a space under the bed is enough to make the TV disappear after viewing. But not only that. Lack of fitted walls or unalterable furniture can make it difficult or aesthetically disharmonious to install a TV. Furthermore, thanks to the very high definition of 4K and 8K panels, only 170 cm is needed for optimal viewing from a 48" TV. Why mount it on a wall?

Up & Down Lift TV. The perfect combination of aesthetics, versatility and space functionality. The Up & Down line of retractable TV lifts integrates inside your furniture, adapting to any type of residential, hotel, naval or tertiary environment. Available in two versions (standard and XL) to accommodate monitors and TVs up to 65".



Under Bed Lift TV

REVÉLO

Description

The EK-BTV-BL TV lift is designed and constructed to move a TV set under the bed. The product in the resting state is placed under the bed; by operating a wired control, the sliding motorised lift brings the TV set into the in-use state. The transition between the two states of rest/use takes place by means of three movements actuated by three electric motors:

Horizontal translation (the TV comes out from under the bed);

Rotation (the TV is brought to a vertical position);

Lifting (the TV is raised to the height pre-set during installation).

Technical data

- Dimensions in rest position (without TV) 1574 x 680 x 221 mm
- Maximum dimensions (without TV) 1930 x 680 x 1740 mm
- Mass (without TV) 80 kg
- Cycle time 25-28 s

Power supply

- Voltage 230 V ± 10%
- Frequency 50 Hz ± 2%
- Current 1.6 A
- Total installed power 150 W
- Required protection IP20

Technical data - Television

- Minimum screen size 32"
- Maximum screen size 55"
- Minimum space between TV and bed frame above 50 mm
- Maximum weight 25 kg

FINISHES

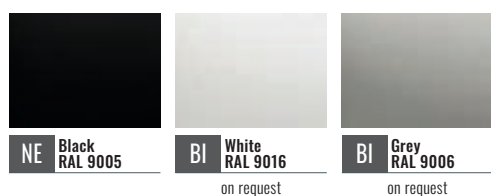

Order information

Code	TV	Package
EK-BTV-BL	da 32 fino a 55"	1 pcs.

Environmental operating conditions

- Closed and dry, domestic environment
- Ambient temperature 5+40 °C
- Relative humidity 30+50 % (without condensation)
- Salinity Excluded
- Solar radiation No
- Vibration No

Transport and storage environmental conditions

- Closed and dry environment
- Ambient temperature -25+55 °C
- Relative humidity 10+80 % (non-condensing)
- Salinity Excluded
- Solar radiation: No
- Vibration: No
- Water and oil splashes, projection of material and substances from nearby machines: No

Functions / Features

- Function control panel with integrated display (for authorised operator only)
- Brackets for wall or bedside mounting
- Colour: black RAL 9005 Gloss 30
- Silent movement
- Wired control for actuating horizontal travel, rotation, lifting movements
- Infrared laser photoelectric sensors with light/dark pulse
- Approval in accordance with EN 60335-1 and UL 962
- Easily removable cover panels for TV cabling
- Compatible with Sky Glass
- For optimal viewing angle we recommend 48" TVs



Documentation

For more information see the technical documentation, download from www.ekinex.com



Up & Down Lift TV

REVÉLO

Description

The TV lift EK-LTV-BL / EK-LTV-XL-BL is a mechanism designed and constructed to move a concealed TV set into cabinets. The product in the resting state is placed inside a cabinet, where the TV set is also concealed; by operating a wired control, the product brings the TV set into the in-use state. The transition between the two states of rest/use takes place via an electric motor integrated in the lifting column. Models differ according to the length of the lifting column.

Technical data

- Minimum/maximum screen size 32" (EK-LTV-BL) / 65" (EK-LTV-XL-BL)
- Minimum space between TV and cabinet shelf: 13.50 mm
- Maximum weight: 25 kg
- Cycle time: 18 - 25 s
- Power supply voltage: 100 - 240 Vac ± 10% @ 50 - 60 Hz ± 2%
- Stand-by power: 0.1 W
- Total power output: 300 W
- Protection required: IP20

- Dimensions in idle position (WxHxD, without TV)
- EK-LTV-BL: 471 x 598,5 / 790 x 174.7 mm
- EK-LTV-XL-BL: 753,5 / 471 x 939 x 171.5 mm

- Maximum dimensions (WxHxD, without TV)
- EK-LTV-BL: 471 x 1445 x 174.7 mm
- EK-LTV-XL-BL: 471 x 1945 x 171.5 mm

- Mass (without TV)
- EK-LTV-BL: 15 kg (33 lb)
- EK-LTV-XL-BL: 16 kg (35 lb)

FINISHES

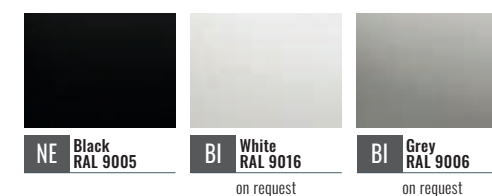

Order information

Code	Height at rest	TV	Package
EK-LTV-BL	790 mm	fino a 43"	1 pcs.
EK-LTV-BL	939 mm	fino a 65"	1 pcs.

Installation dimensions

- EK-LTV-BL: 518 / 545 mm (518 / 545 mm)
- EK-LTV-XL-BL: 700 mm (700 mm)

Maximum excursion closed/open position

- EK-LTV-BL: 655 mm
- EK-LTV-XL-BL: 999 mm

Maximum thrust

- EK-LTV-BL: 700 N
- EK-LTV-XL-BL: 600 N

Bending moment

- EK-LTV-BL: My = max. 150 Nm dynamic
- EK-LTV-XL-BL: My = max. 100 Nm dynamic
- Maximum speed: 38 mm/s

Duty cycle

- EK-LTV-BL: 10 % ~ 2 min at continuous use and full load followed by 18 min break
- EK-LTV-XL-BL: 5 % ~ 2 min. at continuous use and full load followed by 18 min. pause

Functions / Features

- Compact design, guide and actuator are perfectly integrated
- Mounted connector for simple connection to control unit and separate motor cable
- Colour: black RAL 9005 Gloss 30
- Silent movement
- PIEZO™ technology: integrated anti-collision sensor minimises the risk of damage in the up and down direction
- PVC-Free™, made without PVC materials
- Invisible slide rails
- Minimum distance between profiles
- Synchronised movement of the middle profile
- Fixing bracket for wired control
- Motor housing (black) pre-mounted in the movement column
- Approval in accordance with EN 60335-1 and UL 962
- For push applications only
- Compatible with Sky Glass



Documentation

For more information see the technical documentation, download from www.ekinex.com





TOOLS

Planner	388
Bim	389



Planner

TOOLS

Description

PLANNER is a configuration software made available on its website from Ekinex®. This tool, from the easy to use and driven, allows the end user and the designer to identify products that are perfectly suited to the needs of the project. With PLANNER you can also choose and test different combinations of buttons and civil series finishes to get closer as possible to the desired result. PLANNER allows you to fill out a simple list of devices to be used or they can be placed in a preview of a user-uploaded file, in order to recreate the actual conditions of the future installation. Finally, the software allows you to create a database of your projects with the ability to retrieve and modify projects at all times. When you finish using PLANNER allows you the chance to ask Ekinex® the best trade offer to the list of materials in your project

Use in 4 steps

1) ADD A PROJECT

From the Ekinex® site, reach PLANNER by following this link: planner.ekinex.com/en/. At this point you can decide whether or not to insert a map (jpeg, gif, png, pdf image format); in any case you will be asked to give a name to your project, so that you can identify it later.

2) SELECT DEVICES, MODELS AND FINISHING

PLANNER guides you on the page where you can find a list of products and create a list of devices to be installed in the system. All the devices can be placed on the image of the plan if previously inserted.

3) GET THE LIST

PLANNER gives you the ability to export and manage the list of chosen devices, to be able to control the features chosen.

4) SAVE THE PROJECT

By clicking on "save changes", you will save the positions and changes made. You can also print the project and export the list of products in pdf format.

Offer request

Planner is a great business tool. You can request this offer and conditions for devices of your project by clicking on the icon "Request a quote". The network of Ekinex® will contact you and will answer quickly and with the best offer for your project.

For further information contact: sales@ekinex.com

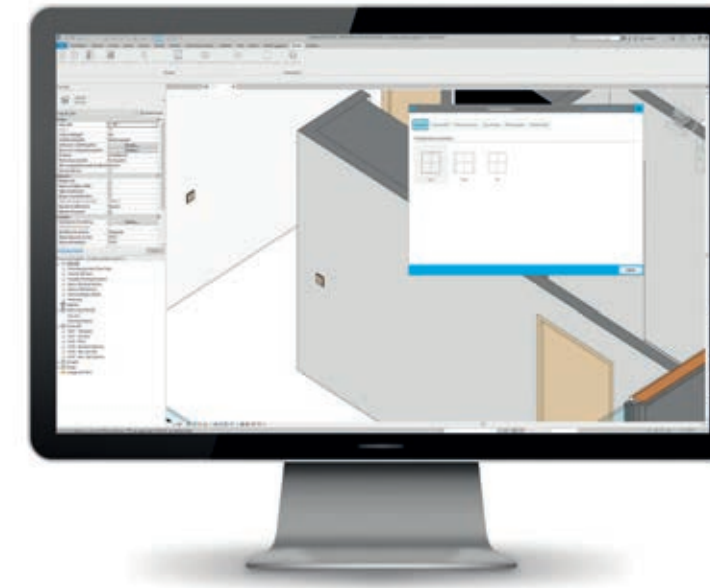

Bim

TOOLS

Description

BIM stands for Building Information Modeling and indicates a methodology aimed at optimizing and managing the design and construction of a building.

The BIM is therefore used mainly in the construction sector to promote a working method that involves the generation of a building model that can also manage the data of the entire life cycle through multi-dimensional virtual models generated digitally by means of specific software.

A BIM can contain any information about the building and its parts. The most commonly collected information is geometry, technical and mechanical data, electrical data, material specifications, financial, energy and environmental assessments.

What are the benefits of bim in home automation and construction?

The role of BIM in the construction industry is to support collaboration between the different actors involved (designers, builders, architects, clients) and integrate the design and simulation processes into a single model that can manage all phases of the life cycle of the building.

The main benefit of adopting the BIM methodology is the 3D representation during the design phase, which speeds up processes, reduces delivery times and allows errors and inaccuracies to be detected first. The greater efficiency in sharing information and a more precise control over all the processes involved, also make it possible to contain costs and schedule in advance maintenance operations.

The fields of BIM related to technology allow the management of complex projects such as home automation and the willingness of the customer to control the building. During the design phase it is already possible to simulate the integration of the different systems and the control of the possible scenarios in a 3D environment, giving all the professionals involved the opportunity to work together without data or process conflicts.

Software

The BIM library is available in Autodesk Revit® format, by installing our **Ekinex BIM Content Creator software**, a real advanced configurator of the product range that will be enriched with future updates and expansions.

For further information:
ekinex.com/en/bim/library-wall-mount.html

eKinex

SALES KIT

Pocket Box	392
Color Ring	392
Glam Box	393
Color Box Pro	393
Style Box	394
Style Case	394
Tech Case	395



Pocket Box

SALES KIT

Description

Pocketbox is a small and versatile tool that allows you to present Ekinex products in their natural size. Inside the box there are many 1:1 scale cardboard models complete with description. Pocketbox is a small and versatile tool that allows you to present Ekinex® products in their natural size.

For further information: sales@ekinex.com

Order information

Code	Package	Weight
EK-POC-BOX-EN	1 pcs.	0.109 Kg



Glam Box

SALES KIT

Description

Glam Box is a finishing box containing all metal, Metal HT and Fenix NTM® samples represented by a square rockers (TQQ) of the FF series.

For further information: sales@ekinex.com

Order information

Code	Package	Weight
EK-GLAM-BOX	1 pcs.	0.200 Kg



Color Ring

SALES KIT

Description

Color Ring is a ring equipped with rectangular keys made of plastic, metal and Fenix NTM® in real size that allows you to evaluate the chromatic combination between the button and the wall.

For further information: sales@ekinex.com

Order information

Code	Finishing	Package	Weight
EK-CC-MET	Metal	1 pcs.	0.152 Kg
EK-CC-FEN	Fenix NTM®		0.117 Kg
EK-CC-PLA	Plastic		0.032 Kg



Color Box Pro

SALES KIT

Description

Color Box Pro is a finishing folder that contains a working KNX button equipped with 12 different materials, colours and button types. It is available in a version completely dedicated to Fenix NTM® and metal.

For further information: sales@ekinex.com

Order information

Code	Finishing	Package	Weight
EK-CBP-MET-FEN	Metal and Fenix NTM®	1 pcs.	1.332 Kg



Style Box

SALES KIT

Description

Stylebox is a presentation box that contains one or more Ekinex devices declined in different colours and finishes to evaluate the different colour and aesthetic solutions available.

For further information: sales@ekinex.com

Order information

Code	Version	Package	Weight
EK-SB4-FF-DK	Style Box FF Form series		
EK-SB4-71-DEEP-DK	Style Box 71 Deep series		
EK-SB4-71-SURF-DK	Style Box 71 Surface series		
EK-SB4-SIGN-DEEP	Style Box Signum Deep		
EK-SB4-SIGN-SURF	Style Box Signum Surface		
EK-SB4-METAL-HT-DK	Style Box Metal HT		
EK-SB4-PWS-IT	Style Box Power sockets/USB - Italian		0.500 Kg
EK-SB4-PWS-DE	Style Box Power sockets/USB - Schuko	1 pcs.	
EK-SB4-PWS-UK	Style Box Power sockets/USB - UK		
EK-SB4-PWS-FR	Style Box Power sockets/USB - French		
EK-SB4-20-SURF	Style Box serie 20venti		
EK-SB4-20-DK			
EK-SB4-4PAN	Style Box Delégo panel 4"		
EK-SB4-5PAN	Style Box Delégo panel 5"		1.500 Kg
EK-SB4-DICO	Style Box Dico		2.300 Kg

Style Case

SALES KIT

Order information

Code	Package	Weight
EK-SC4-02	1 pcs.	9.300 Kg



Description

Style Case was thought to display the Ekinex® wall-mounting devices, appreciate the feel of materials and colours, test the effect on different wall backgrounds. It has four drawers for the different product lines (two of them is equipped with functioning devices) containing demo-versions of wall-mounted devices. Style Case also includes an array of pushbutton faceplates as a colour sampler; the front lid hosts a pouch for catalogues or note sheets. The suede leather belt provides for a convenient carrying handle.

For further information: sales@ekinex.com



Lettering

SALES KIT

Description

Ekinex logo lettering made of 3 mm thick pre-cut forex, complete with installation template with positioning using double-sided adhesive tape.

For further information: sales@ekinex.com

Order information

Code	Package	Dimension
EK-LET-180		180 cm
EK-LET-105	1 pcs.	105 cm
EK-LET-45		45 cm



Description

Ekinex table display with Forest or Wood print, complete with packaging box.

For further information: sales@ekinex.com

Order information

Code	Package	Weight
EK-CROW-FOR (Forest print)	1 pcs.	0.500 Kg
EK-CROW-WOO (Wood print)		

Wall-mount device not included in delivery.

Crowner

SALES KIT



Description

Tech Case is an ideal solution to support KNX training (basic, advanced, hvac) and product presentations. Tech Case is made of a shock-resistant housing and is equipped with an integrated trolley system that makes it suitable for business travels. Tech Case is delivered with connected Ekinex devices and pre-installed application programmes.

For further information: sales@ekinex.com

Order information

Code	Version	Package	Weight
EK-TCB-TP	basic	1 pcs.	11.000 Kg
EK-TCA-TP	advanced		12.000 Kg

Tech Case

SALES KIT



Projecting, configuration and commissioning

TECHNICAL SECTION

The Ekinex® home and buildings automation system was developed in accordance with the KNX open standard; therefore, the planning and the commissioning of a system as well as the configuration of its devices can be carried out easily by means of a PC and the ETS® software. The software allows to program Ekinex® devices, as well as thousands of other interoperable devices produced by companies which are members of KNX Association. All is needed to use Ekinex® devices in a system project, is the download from the www.ekinex.com website of either the application programs general file, the Ekinex® product database containing software for all devices, or the single, specific-application program as necessary. After importing product data into the internal ETS® database, one may start laying out the home automation project.

The first activity required consists of assigning a name to the project, along with general descriptive information, which will permit to re-use the same project without problems, even after a long time. The next step is to define the building's structure and the topology required by the home automation project. The devices are looked up in the database, copied into the structure and assigned a unique id, corresponding to their physical address. At this point, each device may be configured independently, by setting a series of parameters, which vary according to the function to be performed. For example, independent function can be attributed to each different channel of a single push-button command, e.g. switching on or off an electrical appliance, a dimmer for a light source or the opening/closing control for a roll-up shutter. The next step is to define the interaction between multiple devices; unlike traditional installations, where this is achieved by physically laying cables, in a home automation system this action is performed by means of virtual connections generated by the ETS® program.

It is then possible to upload the application program to each device, thereby including all the settings required to perform the expected function within the system. ETS® also has utility functions for diagnoses and error search: for instance, it is possible to verify physical addresses and to check the status of each single devices on the connected bus. Lastly, the program can produce the necessary project documentation for the end user, so that it may be further expanded and adapted in the future. The constant attention of KNX towards the world of professionals developed into a wide offer of training courses. Courses for experts have been offered for years in numerous countries and KNX constantly monitors the activity of all certified training centres, where it is possible to become KNX Partners. The professional role of a KNX Partner is to guarantee a high level of system expertise in order to achieve the best results. Among KNX Partners are designers, installers and system integrators, who offer expert advice to plan, install, run and maintain a KNX-standard control system for homes and buildings.



In order to become KNX Partner, one must withstand a 40-hours theory and practise exam at a KNX-certified Training Centre. A complete list of KNX Partner is available on the website of KNX Association (www.knx.org).



ETS® (Engineering Tool Software) is manufacturer-independent software, produced and marketed by KNX Association (www.knx.org)

KNX technology

TECHNICAL SECTION

KNX systems realize decentralized building automation; therefore, neither a central unit nor a supervising PC for control are required. Each device is fitted with an electronic part, which allows bus communication with all other devices on the bus, processes the received information or transmits the stored working parameters and the logics required for the completion of its task.

Communication

Communication between KNX devices occurs in digital form, by means of serial transmissions of organized information, called "telegrams". A telegram includes the main information to be transmitted – e.g. a switch on or switch off command, a numerical value corresponding to a physical size detected by a sensor, etc. – and a series of accessory information required to guarantee an efficient, error-free communication. Any telegram, which is not duly received, can be repeated up to three times by the transmitting device. In order to avoid collisions between telegrams being sent out at the same time along the same bus from different devices, the CSMA/CA (Carrier Sense Multiple Access / Collision Avoidance) protocol is used. The information transmission speed occurs at 9600 bit/s, which makes it possible to avoid bus line resistor terminations.

Transmission medium

The family of Ekinex® TP bus devices uses twisted-pair signal cables to transmit data; the correct communication is guaranteed by employing bus cables with 1 or 2 conductor pairs made in accordance with KNX Association's TP1 specifications.

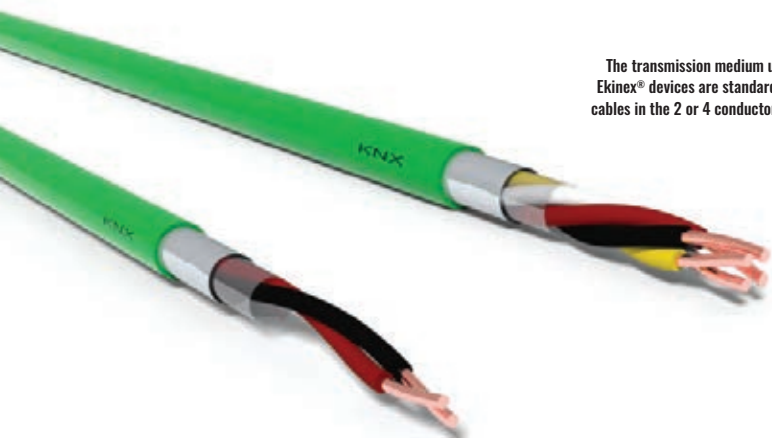

The transmission medium utilized by Ekinex® devices are standard KNX TP1 cables in the 2 or 4 conductors version

Connecting the devices

Ekinex® devices are connected to the signal bus cable by means of the KNX bus termination block. The termination block and the cable form part of a convenient, fast-connection system aimed at eliminating errors: the cable has rigid connectors and the termination block is fitted with holding springs (instead of screws); besides, the termination block is formed by two elements having the same colour-coding (black/red) of the conductors to be connected. Each stripped bus conductor will be simply inserted in place, where it will stay firm thanks to the provided holding spring. Each polarity has 4 connection areas and the termination block may be extracted from its seat: Thanks to these two characteristics, the removal of any device from the bus cabling does not determine the interruption of communications with the remaining devices. The termination block is also used for branching cable segments on the same bus.



Installation

KNX bus cables can be laid underneath the 230 Vac power cables along the same duct, provided they are kept isolated. Should the insulating sheath be removed, a distance of at least 4 mm between cable types must be guaranteed.

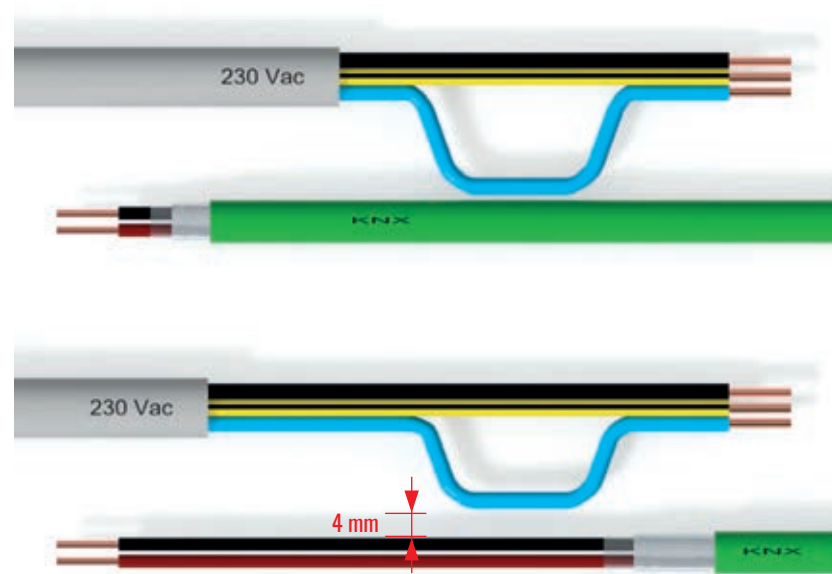

Topology

The smallest KNX system may include a single bus line along which up to 64 devices can be connected. The line must be equipped with the special bus power supply, which provides the necessary SELV voltage for the system to work. The effective number of bus devices that can be connected to the line is determined at project level and may vary depending on the voltage supplied by the bus power supply and on the electrical absorption of each device on the bus. Since each Ekinex® device can process multiple functions, a single-bus line can suffice to control an apartment, a detached house or even a larger building with a limited number of bus functions.

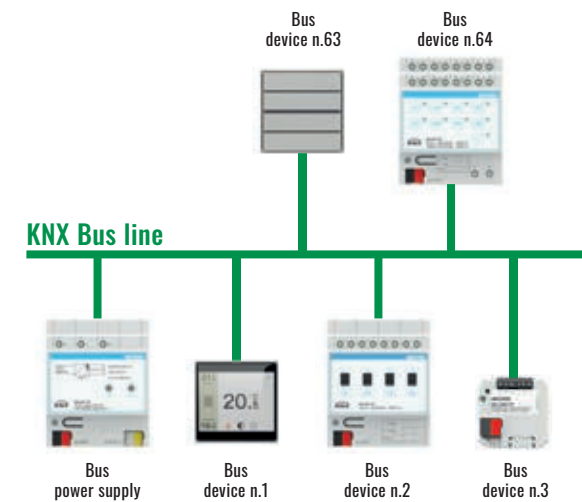

Next to a simple single-line configuration, a bus line can be subdivided into more segments, thus obtaining a star-shaped or a tree-shaped topology, or any combinations of the two.

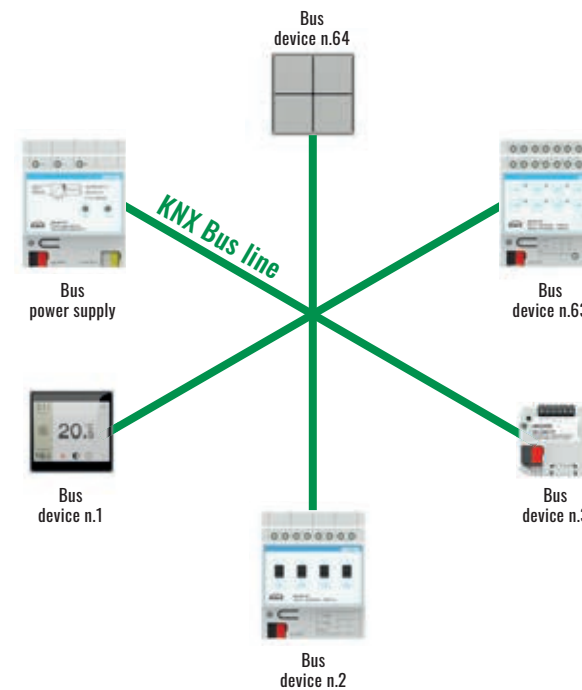

Adding line couplers, allows the system to expand to accommodate for larger buildings and/or higher numbers of required bus functions. Connecting more lines between them by means of couplers and a backbone line constitutes an area. An area is formed by a backbone line, up to 15 secondary lines and by all the devices connected along them. A unique number between 1 and 15 characterizes each secondary line. With little less than 1000 connectible KNX devices, an area permits the handling of a medium/large size system.

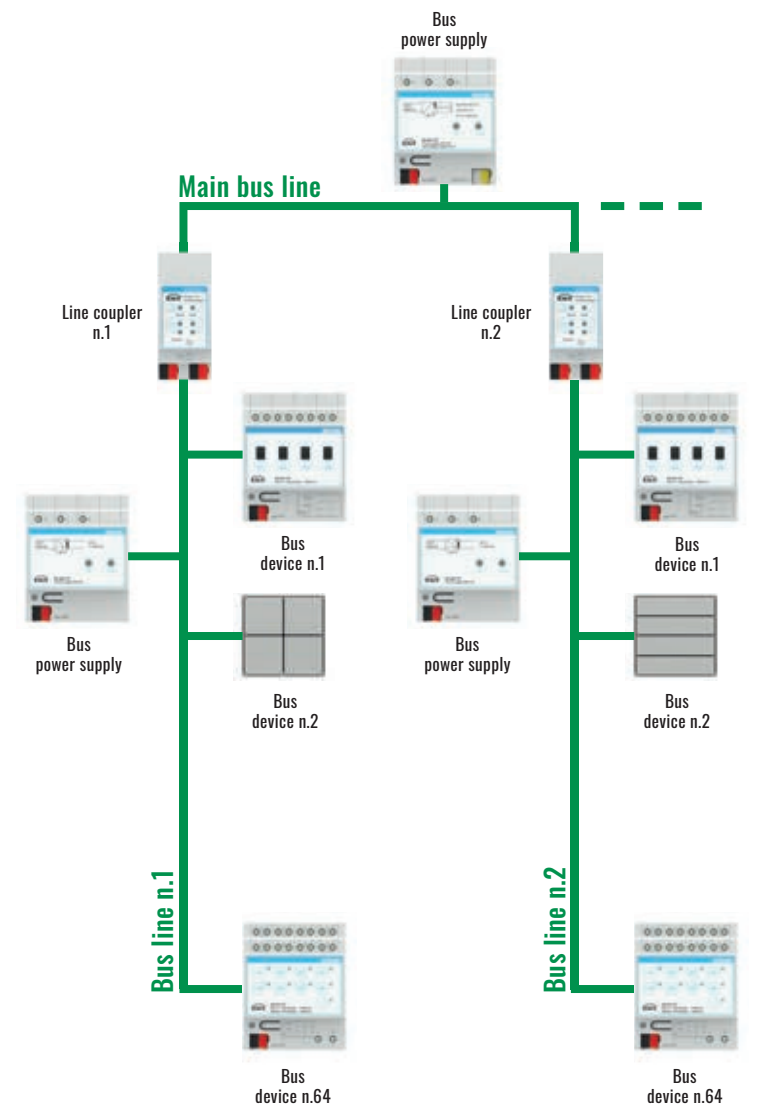

KNX technology

TECHNICAL SECTION

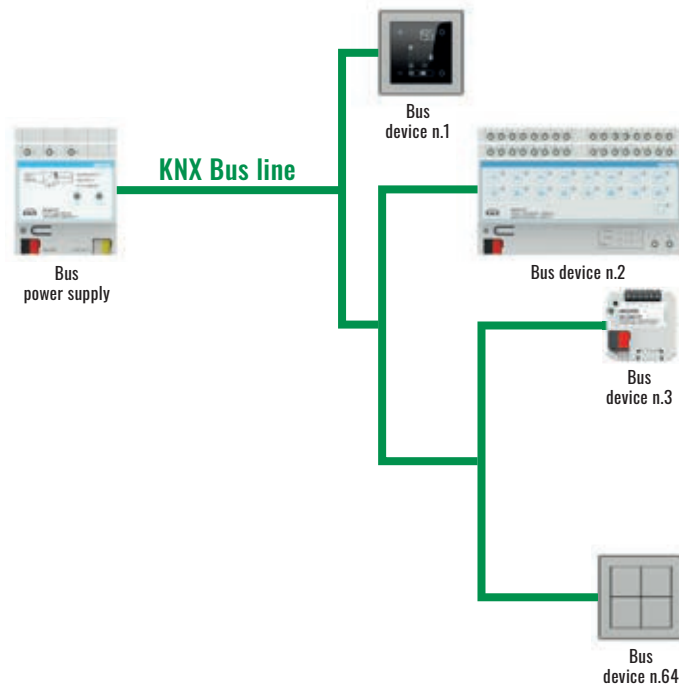

It is necessary to respect KNX topology prescriptions while designing the system, in order to guarantee communication within the system:

- the maximum allowed line length is 1000 m, including all branches;
- up to 64 bus devices can be connected to one line;
- the maximum distance between 2 devices is 700 meters;
- no bus device may be more than 350 meters apart from a bus power supply;
- in case of high numbers of bus devices (> 30) along limited sections lengths (10m), a second bus power supply can be installed, provided it sits at least 200 meters away from the first.

Should the demand increase, a KNX system can be further extended by connecting one another up to 15 areas. The main lines of each single area are connected to a backbone line by means of area couplers. Areas and main lines are numbered 1 to 15, while the backbone line bears number 0. The most extended KNX system permits to connect tens of thousands of devices, thus satisfying the necessities of very large buildings.

Device addressing

The bus is a shared communication medium and each connected device must be exclusively distinguished from all others. The ETS® program takes care of that by assigning a physical address to each device; the address is represented in the form "area.line.device". Thanks to that, the topology of the entire system is mirrored into the devices' physical addresses, making it easy to locate a device in the whole topology, by simply knowing its physical address. For instance:

3.5.12 is the physical address of the bus device number 12, installed along line 5 in area 3

7.11.4 is the physical address of bus device number 4 on line 11 in area 7

A line coupler connects a secondary line to the backbone line; the device forms an integral part of the secondary line and conventionally assumes the device number "0". The physical address of a line coupler can be, for instance:

3.5.0 is the physical address of the coupler connecting the secondary line n. 5 to the main line of area 3

The area coupler connects an area's main line to the backbone line; the device is part of the main line and conventionally assumes device number "0" and line number "0". The physical address of an area coupler is, for example:

3.0.0 is the physical address of the coupler connecting the main line of area 3 to the system's backbone line

KNX technology

TECHNICAL SECTION

The physical address of the transmitting device is always present in a telegram, working as the "source address" of the message.

<h2>3.5.12</h2>	The physical address (area.line.device) is used when programming and diagnosing bus devices.
<h2>2/6/54</h2>	The group address is used when commanding and controlling the bus devices.

To coordinate the performance of several devices over a particular bus function, a so-called group address is used; this is represented by a two levels structure "main group/subgroup" (e.g. "2/15") or by a three level structure "main group/middle group/subgroup" (e.g. "2/6/54"). This type of address is almost exclusively used as a "destination" address for telegrams.

Power supply

KNX systems work with the 30 Vdc SELV (Safety Extra Low Voltage) voltage, supplied by the bus power supply present on each line; this power feeds the electronic parts of the devices and provides for the transmission of information over the bus. Normally, KNX commands and sensors are exclusively connected to the bus line, while parts of KNX actuators require a separate 230 Vac power supply for commanding connected loads. Some devices may require an auxiliary SELV power supply for their operation.

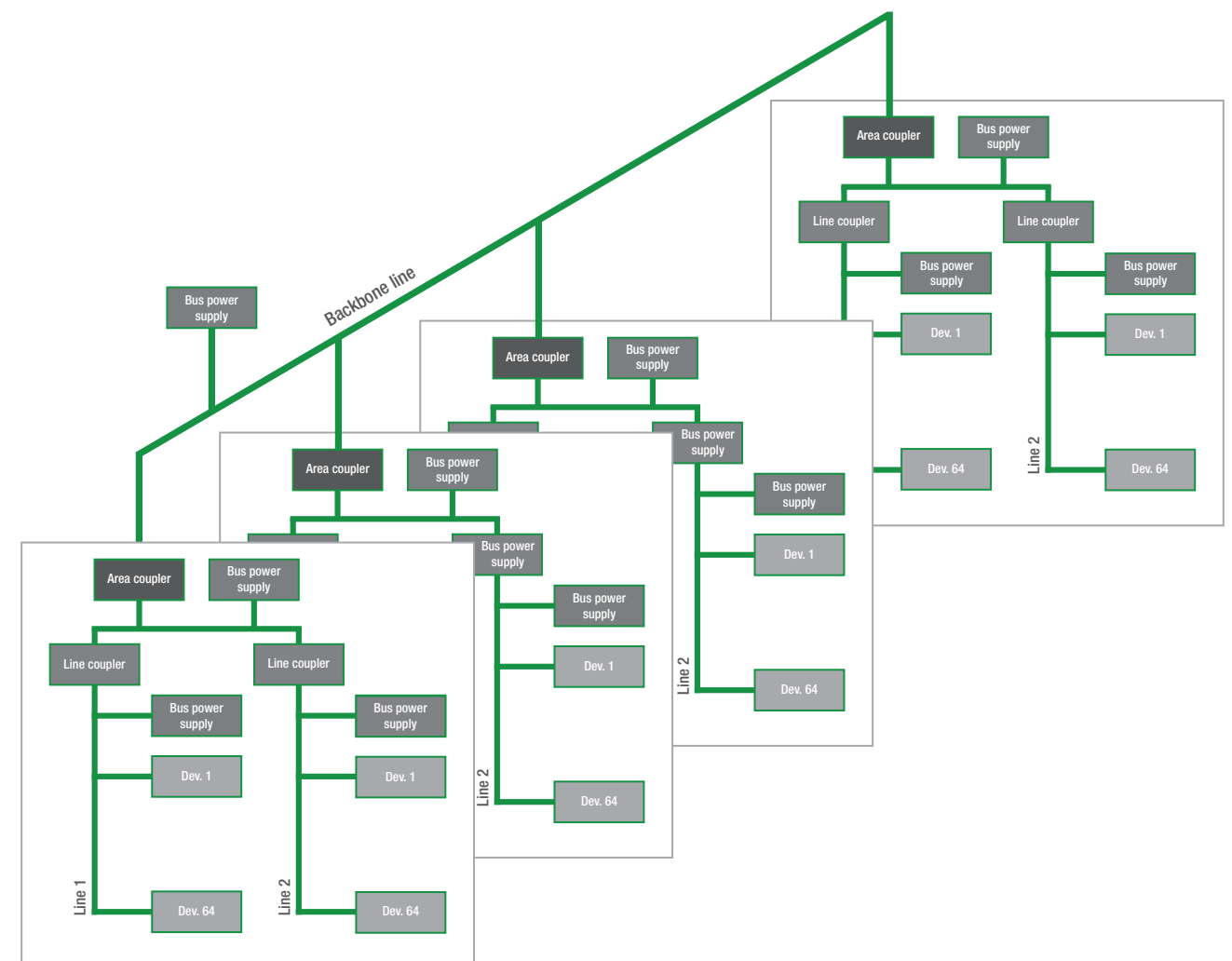

Normative references

TECHNICAL SECTION

Norms are, by nature, voluntary application dispositions; anyhow, complying with norms constitutes the best guarantee in the choice of a product for designers, installers and end users. In fact, norms are "state-of-the-art" developments in their technology sector and precisely define quality, performance and safe conditions of use for a product. Beyond safety norms regarding all products, the systems for the control of houses and buildings are more often requested to integrate energetic

efficiency models, consistently abiding to recent tendencies aiming at global system-envelope system efficiency, more so than seek optimization of single parts. KNX represents an open and interoperable system for the automation of houses and buildings, normed at global level thanks to its conformity with international (ISO/IEC 14543-3), European (CENELEC EN 50090, CEN EN 13321-1 e 13321-2), Chinese (GB/Z 20965) and American (ANSI/ASHRAE 135) norms.

Norm	Title	Notes
ISO/IEC 14543-3	Information technology - Home electronic system (HES) architecture	In sight of the great interest towards KNX compatible products and the technology by them consolidated well beyond European markets, the KNX Association took all necessary steps to obtain approval of its own KNX standards at international levels. At the end of 2004, active CENELEC member countries proposed the European EN 50090 norm for ISO/IEC standardization. In November 2006, the KNX protocol and all transmission media (TP, PL, RF and IP) became approved and published under the international ISO/IEC 14543-3-x normative.
EN 50090	Home and Building Electronic Systems (HBES)	In December 2003, the KNX protocol and the two TP (twisted pair) and PL (power line) transmission media were approved by the European national committees and ratified by the CENELEC Bureau Technique under the European EN 50090 norm. The transmission medium KNX RF (radio frequency) was approved the month of may 2006.
CEN EN 13321-1	Open data communication in building automation, controls and building management. Home and building electronic system. Product and system requirements	Since KNX supplies more and more technical specifications used not only for the automation of electrical devices, but also for HVAC (Heating, Ventilation and Air Conditioning) applications, the KNX Association submitted its specifications to CEN for publishing a European normative for building control systems. CEN accepted the proposal and KNX specifications where published by CEN as EN 13321-1 and EN 13321-2.
CEN EN 13321-2	Open data communication in building automation, controls and building management. Home and building electronic systems. KNXnet/IP Communication	
GB/Z 20965	Control network HBES technology specification - Home and building control	The great interest demonstrated by China for KNX products and technology was the main reason for the KNX Association to have the international ISO/IEC 14543 norm translated into Chinese. The Chinese standardization committee SAC TC 124 introduced the KNX standard into China and adopted it under the GB/Z 20965 norm in July 2007.
ANSI/ASHRAE 135	BACnet - A Data Communication Protocol for Building Automation and Control Networks (ANSI Approved)	Even the interfacing of KNX with other automation systems is now internationally standardized: the norms US ANSI/ASHRAE 135 and ISO 16484-5 support mapping between KNX and BACnet.
CEI EN IEC 63044-3	2018 Home and Building Electronic Systems (HBES) and Building Automation and Control Systems (BACS)	Part 3: Electrical safety requirements
CEI EN IEC 63044-5-1	2017 Home and Building Electronic Systems (HBES) and Building Automation and Control Systems (BACS)	Part 5-1: EMC requirements, conditions and test set-up

Normative references

TECHNICAL SECTION

The EN 50090 norm

The European EN 50090 norm "Home and Building Electronic Systems (HBES)" was developed at CENELEC from the TC 205 Technical Committee, specifically established in 1996 to write norms covering all relevant aspects of electronic systems dedicated to the control of homes and buildings. Parts of the norm were progressively released and published by the standard committee of several European countries giving birth to the national norms about the electronic systems for homes and buildings.

Beyond the requirements for the development of HBES systems and components, aimed at builders, the norm also defines the criteria for designing, installing and testing an HBES system. The KNX standard is entirely compliant with the EN 50090 norm.

Part	Home and Building Electronic Systems (HBES) - Title of the part	Year
EN 50090-1	Part 1: Standardization structure	2011
EN 50090-2-1	Part 2-1: System overview - Architecture	1998
EN 50090-2-2/A2	Part 2-2/A2: System overview - General technical requirements	2008
EN 50090-2-3	Part 2-3: System overview - General functional safety requirements for products intended to be integrated in HBES	2006
EN 50090-3-1	Part 3-1: Aspects of application - Introduction to the application structure	1997
EN 50090-3-2	Part 3-2: Aspects of application - User process for HBES Class 1	2004
EN 50090-3-3	Part 3-3: Aspects of application - HBES Interworking model and common HBES data types	2010
EN 50090-4-1	Part 4-1: Media independent layers - Application layer for HBES Class 1	2006
EN 50090-4-2	Part 4-2: Media independent layers - Transport layer, network layer and general parts of data link layer for HBES Class 1	2005
EN 50090-4-3	Part 4-3: Media independent layers - Communication over IP	2008
EN 50090-5-1	Part 5-1: Media and media dependent layers - Power line for HBES Class 1	2005
EN 50090-5-2	Part 5-2: Media and media dependent layers - Network based on HBES Class 1, Twisted Pair	2005
EN 50090-5-3	Part 5-3: Media and media dependent layers - Radio frequency	2007
EN 50090-7-1	Part 7-1: System management - Management procedures	2005
EN 50090-8	Part 8: Conformity assessment of products	2001
EN 50090-9-1	Part 9-1: Installation requirements - Generic cabling for HBES Class 1 Twisted Pair	2005
CLC/TR 50090-9-2	Part 9-2: Installation requirements - Inspection and testing of HBES installation	2009

Energy efficiency in buildings

TECHNICAL SECTION

Based on the fact that buildings in Europe account for over 40% of total energy consumption, the European Union intensified its efforts over the last years so that buildings be projected and re-qualified, thereby restraining consumptions as much as possible. The declared objective is to reduce energy dependence and the emission of polluting and climate-changing gases. The starting point was the publishing of Directive 91 in 2002 about energy performance in building (known as EPBD – Energy Performance Building Directive) - a mandatory implementation for European Union countries – which introduced important new facts, such as the energy performance certification, aimed at informing users about the building’s energy performance and leaving up to national measures the identification of the most appropriate interventions needed to increase energy efficiency. The innovative approach required coordinated interventions on the envelope-system integrated system.

Final energy consumption by sector (EU)

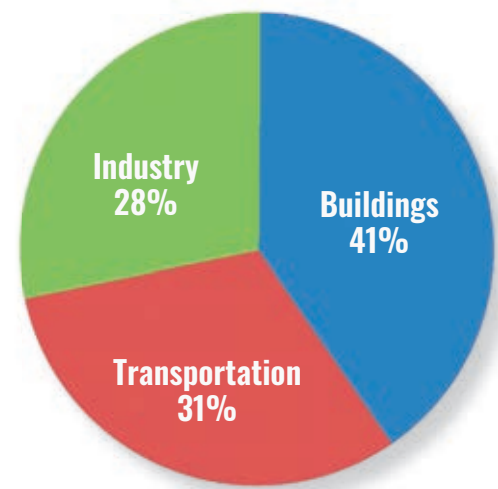

The EN 15232 norm

Following the Directive 2002/91/EC, the next step is to pay attention to efficiency recovery in individual behaviours and to concentrate on the relationship between the rate of automation in a building’s plan and the corresponding achievable energy saving. This has brought CENELEC to publish the EN 15232 norm, later acknowledged by the standard committee of several European countries. The norm evaluates the savings achievable through the adoption of growing automation levels – both during planning and energy verification operations – and to place buildings in one of four energy efficiency classes: from A (the most efficient) to D (the least efficient).



BACS: Building Automation Control System
TBM: Technical Building Management System



A class

A class includes highly energy-efficient buildings, fitted with control and automation systems (BACS) and technical system management (TBM), characterized by high levels of precision and completeness in terms of automatic control.

B class

B class includes energetically advanced buildings, fitted with control and automation systems (BACS) and technical system management (TBM) allowing a centralized-type of control.

C class

C class includes buildings, which are standard from an energy point of view and are fitted with basic control and automation systems (BACS). This class is also used as a reference for the calculation of efficiency factors.

D class

D class includes buildings, which are not energy-efficient, having technical systems exclusively of a traditional type, lacking any kind of automation.

The EN 15232 norm also specifies:

- a structured list of regulation functions, automation and technical management which have a certain effect on the energy efficiency of buildings;
- a method to define minimal requirements to apply for regulation, automation and technical management of buildings of different complexity;
- detailed methods to evaluate the effects of such functions on a specific building;
- a simplified method to reach a first impact estimate of such functions on representative buildings.

Quality certification

The Ekinex® products described in this catalogue are developed and built in conformity with the quality management system adopted by Ekinex S.p.A. and certified by DNV – Det Norske Veritas – in accordance ISO EN 9001:2008.

Access through mobile devices

All QR* codes appearing on product catalogue pages, provide quick access - at any time and from any place – to technical documentation or any other web content published at www.ekinex.com, by using mobile devices such as smart-phones or tablets. In order to decode QR, one simply must upload to his mobile device any freeware application found online.

(*) QR Code® is a trademark registered by Denso Wave Incorporated

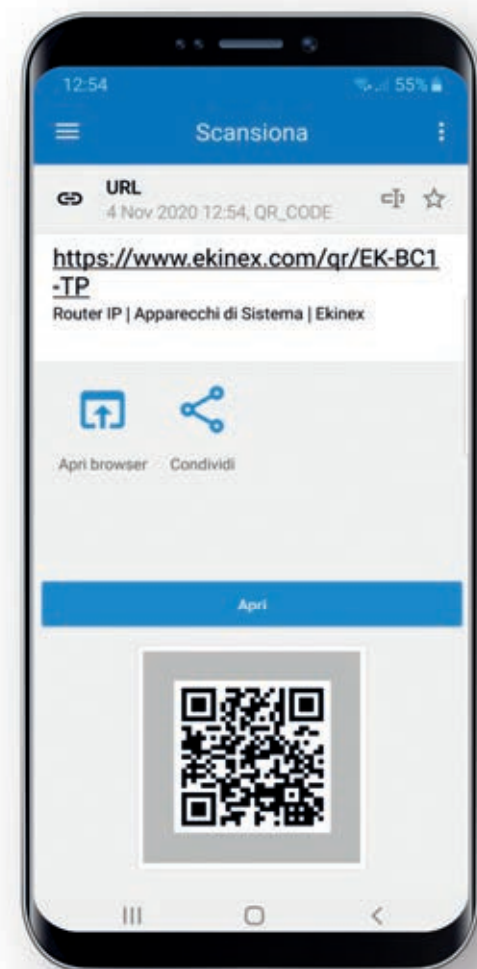

Documentation on the Web

All tech documents for Ekinex® devices are available for download from the www.ekinex.com website, without requiring any registration. The search is free, and products may be searched by their code, family or type. The same documentation can quickly be accessed from within the product pages, too.



ETS application software in several languages

All Ekinex® devices have ETS application software in 4 languages: English, German, French and Italian.

Single packaging

Ekinex® devices are individually protected against shock & dust by means of a dedicated packaging. The label clearly describes the contents and bears both an (EAN) bar-code and a QR. Inside the packaging, the instructions sheet supplies information for the installation of the product.

General terms of sale

Valid for the Ekinex® product range.

1. DEFINITIONS

- 1.1 In these General Terms and Conditions of Sale, the terms below shall have the following meaning:
 - a) "Manufacturer": Ekinex S.p.A. with registered office in Vaprio d'Agogna (28010 NO), via Novara 37;
 - b) "Purchaser": professional customer, sole proprietor or company, requesting the purchase of Ekinex® products;
 - c) "Party" or "Parties": Ekinex S.p.A. and the Buyer;
 - d) "Order" or "Orders": the order or purchase orders concerning Ekinex® products issued by the Purchaser to Ekinex S.p.A.;
 - e) "Products": all Ekinex®-branded products for home and building control, which can be found in the Ekinex® product catalogue in printed and/or electronic form and on the website www.ekinex.com;
 - f) "General Conditions": the general conditions of sale set out below.

2. SCOPE OF APPLICATION

- 2.1. These General Terms and Conditions of Sale govern all purchase contracts concerning Ekinex® products concluded between the Parties;
- 2.2. The Buyer may not invoke or object to any conditions other than those contained in the General Conditions. Consequently, any conditions specified in writing shall have no validity, by the Buyer on the Order, or at any other stage of the contractual negotiation, and also after acceptance or knowledge of the General Conditions, as well as any other terms and conditions that the Buyer may have. General conditions of purchase of the Buyer. The execution, even partial, of the Order by Ekinex S.p.A. or any other fulfilment by Ekinex S.p.A. towards the Buyer is not valid and does not apply to the Buyer. Shall be construed as tacit or implicit acceptance of any general terms and conditions other than these Conditions, unless expressly accepted in writing by Ekinex S.p.A. Even in the event of derogations agreed upon in writing, these conditions shall continue to apply for the parts not expressly derogated.
- 2.3. The General Terms and Conditions are only valid for contractual relations between Ekinex S.p.A. and professional traders, and therefore Legislative Decree no. 206 of 6 September 2005 shall not apply. (Consumer Code) and subsequent amendments.
- 2.4. Ekinex S.p.A. reserves the right to amend these General Terms and Conditions of Sale at any time, which shall be communicated to the customer without prior notice. Each contract shall be governed by the General Terms and Conditions of Sale in force at the time the order is placed by the Customer.

3. FORMATION OF THE CONTRACT

- 3.1. The acceptance by the Buyer of the offer or the confirmation of the order by Ekinex S.p.A., in whatever manner, entails the application of these General Conditions of Sale.
- 3.2. The offers made by agents, representatives and commercial auxiliaries of Ekinex S.p.A. are not binding for Ekinex S.p.A. until they have been confirmed by Ekinex S.p.A. in writing. The offers of sale made by Ekinex S.p.A. are valid for 30 days from the date of their formulation and are limited to the complete supply of what is listed therein. After the expiry of this period, the offer to sell shall no longer be valid.
- 3.3. The Order sent by the Purchaser to Ekinex S.p.A. constitutes an irrevocable contractual proposal binding for a period of three months, starting from the moment Ekinex S.p.A. becomes aware of it.

Within the aforementioned three months Ekinex S.p.A., at its sole discretion, reserves the right to accept or refuse the Order, informing the Buyer accordingly.

In the event that the order confirmation of Ekinex S.p.A. differs from the order sent by the Buyer with regard to the quantity of products, prices, discounts and delivery methods, this confirmation shall be considered as a counter proposal by Ekinex S.p.A., which must be expressly accepted by the Buyer in order for the contract to be considered concluded.
- 3.4. By sending the order, the Customer acknowledges and declares that he/she has read all the information provided to him/her during the purchase procedure and that he/she fully accepts these General Terms and Conditions of Sale.
- 3.5. Acceptance is expressed by a confirmation e-mail sent to the e-mail address indicated by the Customer. The confirmation message shall contain the date and time of the order and a 'Customer Order Number' to be used for any further communication with Ekinex S.p.A.. The customer may monitor the status of the order at any time by contacting Ekinex S.p.A. at the following telephone number +39 0321 1828980 or at the following e-mail address sales@ekinex.com.
- 3.6. If the Buyer cancels the Order before its acceptance or execution by Ekinex S.p.A., Ekinex S.p.A. may ask the Buyer to reimburse the costs of the Order.

4. PRODUCT AVAILABILITY

- 4.1. Ekinex S.p.A. reserves the right to change the Ekinex® product catalogue and the technical characteristics of the products without prior notice.
- 4.2. If one of the requested products is not available, Ekinex S.p.A. undertakes to contact the Customer within 20 working days from the time of placing the order, communicating by e-mail, to the email address provided by the customer, the unavailability and possible alternative solutions. In this case, the customer can wait for the delivery of the order, if Ekinex S.p.A. believes that it can be found on the market. The product is not available or cancel the order and receive a refund of any price already paid.
- 4.3. Before purchasing each product, carefully check the installation requirements according to the regulations of the country where the installation will take place and compatibility according to the design specifications.
- 4.4. Ekinex guarantees the correct installation of its products only with the flush-mounting boxes shown in the planner or technical catalogue. For the use of different flush-mounting boxes we recommend that you contact our technical support (support@ekinex.com) or check the correct installation yourself.

General terms of sale

5. PAYMENT METHODS

- 5.1. The prices of the products refer to the price list in force at the time of acceptance of the sale offer by the Buyer or at the time Ekinex S.p.A. issues the order confirmation.
- Ekinex S.p.A. reserves the right to modify the current price list at any time, after written notice to the Buyer, in the event of increases in the cost of raw materials, labour costs or any other factor leading to a significant increase in production costs. The prices of the products are always Ex-Carrier (FCA Incoterms 2010) and therefore the risks related to the supply shall pass to the Buyer at the time the products are handed over to the carrier, unless otherwise agreed upon in writing between the parties.
- 5.2. Payments must be made in accordance with the relevant information contained in the sales offer or order confirmation. Payments and any other sum due for any reason to Ekinex S.p.A. shall be made at its domicile and, unless otherwise agreed, in Euros.
- 5.3. Any delay or irregularity in payment gives Ekinex S.p.A. the right to
- suspend ongoing supplies, even if not related to the payment in question;
 - vary the terms of payment and discount for subsequent supplies, including by requiring advance payment or the provision of additional guarantees;
 - demand, from the due date for payment and without the need for formal notice, default interest on the sum still due, at the rate provided for by the rules of the law currently in force for commercial transactions (in particular Legislative Decree 231/2002 and subsequent additions), without prejudice in any case to the right of Ekinex S.p.A. to claim compensation for any additional costs incurred damage suffered. Moreover, in the above mentioned cases, any amount due to Ekinex S.p.A. for any reason whatsoever becomes immediately due. The Buyer shall be obliged to pay the products in full even if exceptions, disputes or controversies arise which will only be settled after payment of the amount due;
 - terminate the contract pursuant to Article 1456 of the Italian Civil Code by notifying by registered letter with return receipt or certified e-mail the intention to exercise this right. The termination shall be effective for both parties from the date of receipt of the communication.

6. TRANSPORT AND DELIVERY OF PRODUCTS

- 6.1. The delivery of the goods is Ex-Carrier (FC Incoterms) and therefore the risks relating to the supply pass to the Buyer at the moment the products are handed over to the carrier, unless otherwise stated written agreements between the parties.

The delivery terms, unless expressly agreed otherwise, are purely indicative. In the event that the execution of the order is prevented by the occurrence of circumstances of force majeure, by the failure to regularity of supplies of raw materials or other unforeseeable circumstances occurring, the delivery terms shall be deemed extended and new terms shall be determined by mutual agreement between the parties, without any compensation and/or damages being awarded for the delay in delivery.

- 6.2. Upon delivery of the goods by the courier, the Customer is obliged to check that the contents of the package delivered correspond to what was ordered and indicated in the invoice sent by email.

Any damage to the packaging and/or to the product or the mismatch between the number of packages and the invoice must be reported within 3 working days of delivery to customer service of Ekinex S.p.A. at the following e-mail address sales@ekinex.com. After the expiry of this period, the customer may no longer make any complaints about the external characteristics of the product delivered as well as on the number of packages received.

7. FORCE MAJEURE

- 7.1 Force Majeure is the occurrence of an event or circumstance ("Force Majeure Event") which prevents a party from performing one or more of its contractual obligations if, and to the extent that, the party who suffers the event feels:
- that such impediment is beyond its reasonable control;
 - the event could not reasonably have been foreseen at the time of the conclusion of the contract;
 - that the effects of the impediment could not reasonably have been avoided or overcome by the Interested Party.
- 7.2 Where a party fails to perform one or more of its contractual obligations because of the non-performance of a third party, entrusted by the party to perform all or part of the contract, that party may invoke force Majeure only to the extent that the requirements of paragraph 1 are met by both the party and the third party.
- 7.3 In the absence of proof to the contrary, the following events suffered by a party shall be presumed to satisfy the conditions of paragraph 1 of this clause and that party shall only have to prove the existence of the condition in paragraph 1.
- war (whether declared or not), hostilities, invasion, acts of a foreign enemy, extensive military mobilisation;
 - civil war, riot, rebellion, revolution, military force or usurpation of power, insurrection, acts of terrorism, sabotage or piracy;
 - currency or trade restrictions, embargoes, sanctions;
 - acts of authority, whether lawful or unlawful, compliance with laws or governmental orders, regulations, expropriation, confiscation of property, requisition, nationalisation
 - plague, epidemic, natural catastrophe or extreme natural events;
 - explosion, fire, destruction of equipment, prolonged suspension of transport, telecommunications or power
 - generalised social conflicts, such as, in particular, boycotts, strikes and lock-outs, white strikes, occupation of factories and buildings.
- 7.4 The Interested Party shall notify the other party without delay of the occurrence of the event.

General terms of sale

- 7.5 The party who successfully invokes this Clause shall be released from its obligation to perform its contractual obligations, from any liability for damages or other contractual remedy for non-performance, from the time the event inhibits the performance of its contractual obligations, provided that it has been notified without delay. If notice of the event has not been given promptly, the release takes effect from the time when the notice reaches the other party. The other party may suspend performance of its obligations, if any, from the date of the notice.
- 7.6 If the effect of the impediment or event invoked is temporary, the consequences referred to in paragraph 5 shall occur only to the extent and for as long as the impediment or event invoked prevents the interested Party from performing its contractual obligations. The Interested Party shall inform the other Party as soon as the impediment ceases to prevent the performance of its contractual obligations.
- 7.7 The Interested Party shall take all reasonable steps to limit the effects of the invoked event on the performance of its contractual obligations.
- 7.8 If the duration of the invoked impediment has the effect of substantially depriving one or both parties to the contract of what they could reasonably expect under the contract, each party shall have the right to terminate the contract by giving notice to the other party within a reasonable period. The parties agree that, unless otherwise agreed, the contract may be terminated by either party if the duration of the impediment exceeds 120 days.
- 7.9 If paragraph 8 applies, and one of the parties has derived a benefit from the performance of the contract before its termination, it will be obliged to compensate the other party for the value of that benefit.

8. GUARANTEES

- 8.1. Ekinex S.p.A. guarantees the conformity of the Ekinex® products with the legislation and technical standards in force in the EEC.
- 8.2. Ekinex S.p.A. guarantees that the quality and type of the delivered products correspond to the contract and that they are free from defects that could make them unsuitable for the use for which they are intended.

The guarantee for construction defects is limited to those defects of the products that are attributable to defects in the material used or to design and construction problems attributable to Ekinex S.p.A..

All Ekinex® products sold by Ekinex S.p.A. are covered by the warranty for good functioning and the warranty for defects and/or faults in design and manufacture for a period of 24 months and therefore also in accordance with the Consumer Code if the end user is a consumer.

- 8.3. The warranty operates from the date of delivery of the goods by Ekinex S.p.A., except for the parts that are subject to normal wear and tear. After the expiration of this period, the warranty ceases, even if the products have not been put into operation for any reason at the end user.

Please note that the warranty on the products purchased from Ekinex S.p.A. is subject to the full payment of the products.

- 8.4. The above mentioned warranty is effective on condition that the products have been stored and used in accordance with the instructions in the General Catalogue and the technical data sheets provided by Ekinex S.p.A., that no repairs, modifications or alterations have been carried out without the prior written consent of Ekinex S.p.A. and that the defects found have not been caused by chemical or electrical agents.
- 8.5. The Purchaser shall report any defects in writing no later than 8 days after the delivery of the products, while the report of any hidden defects and/or operating defects (that can only be detected after the use of the product) must be made within 8 days after the discovery of the defect.
- The warranty does not apply in the event of malfunctions of the software installed on the Product, which are due to overloads, electrical phenomena due to atmospheric events, interruptions and/or suspensions of electricity.
- 8.6. The notification of defects, including hidden defects, must be made in writing to Ekinex S.p.A. by sending a communication to support@ekinex.com within the prescribed period, indicating 1) the reference of the invoice with which the product was purchased, 2) the serial number of the product, 3) a brief technical report of the defects or non-conformities found and 4) if the end user is a consumer, the communication with which the latter has complained about the defect.
- 8.7. If the purchaser does not allow Ekinex S.p.A. to carry out any reasonable checks as requested by Ekinex S.p.A. and does not return the defective products to Ekinex S.p.A. within 60 days after delivery, the warranty right is forfeited.

In order to return the defective products, Ekinex S.p.A. shall, unless otherwise agreed, collect the defective material at its own expense according to the instructions on the day and place agreed upon by the parties. After the return, the defective products shall become the exclusive property of Ekinex S.p.A..

After the expiration of the above mentioned terms, Ekinex S.p.A. shall consider the latter as forfeited from the warranty and therefore invoice the products sent to replace the defective ones and consequently request the payment of the same.

- 8.8. Ekinex S.p.A., a) supply products of the same type (or equivalent) and quantity of those found to be defective free of charge at the registered office of the purchaser (DAP Incoterms 2010), subject to the return of the replaced products by the customer in the terms and conditions stated in paragraph 7. b) repair the defective products at the customer's premises, in accordance with the terms and conditions stated in paragraph 7. 7: b) repair the defective products if Ekinex S.p.A. does not find the necessity or urgency for an immediate replacement of the same; c) issue a credit note in favour of the Purchaser for an amount equal to the value indicated on the invoice of the returned products.

Ekinex S.p.A. shall only provide in the above ways if the purchaser has done everything within its competence.

Unless otherwise agreed between the Parties, it is understood that all the expenses related to the interventions carried out by the technical assistance of Ekinex S.p.A. shall be borne by the same.

Both in case of replacement and repair of defective products or components, the original warranty period shall continue to run, which shall not be renewed.

It should also be noted that once the correctness of the warranty request has been established Ekinex S.p.A. will only replace the defective products as indicated in this point 7.8, thus excluding that the customer may request the termination of the contract and/or compensation for damages.

- 8.9 In the event that the defects of the products are not attributable to Ekinex S.p.A., the costs of repair and replacement of the products will be charged to the customer.

The warranty referred to in this article is in lieu of the legal warranties for defects and conformity and excludes any other possible liability of Ekinex S.p.A. arising from the products supplied. In particular, the Purchaser may not make any other claims for damages and Ekinex S.p.A. shall not be held responsible for indirect or consequential damages.

General terms of sale

9. INDUSTRIAL PROPERTY

9.1. Ekinex S.p.A. remains the exclusive owner of the patents, drawings, projects and everything used for the manufacture of the Products, which the Purchaser therefore undertakes not to hand over to third parties, reproduce or use. If the manufacture of the Products is carried out by Ekinex S.p.A. upon the specific request and technical documentation of the Buyer, Ekinex S.p.A. shall not assume any responsibility for the infringement of industrial property rights of third parties, which shall instead be the exclusive responsibility of the Buyer, who undertakes to guarantee and keep Ekinex S.p.A. indemnified and unharmed against any claim made against it.

9.2. The Purchaser undertakes to use the trademarks of Ekinex S.p.A. only for the purpose of identifying, advertising and selling the Products, and shall refrain from depositing them or having them deposited without the prior written consent of Ekinex S.p.A..

10. TERMINATION AND WITHDRAWAL

10.1 The buyer, in accordance with article 1454 of the Italian civil code, must give Ekinex S.p.A. a written notice to comply with the contract within a period of time that is not less than 30 days, before acting to terminate the contract due to non-fulfilment. If Ekinex S.p.A. has started to perform within this period, the buyer shall not be able to terminate the contract. (A termination period for Ekinex may also be included, but the termination for non-payment may be decided on the basis of the obligations imposed on the customer in addition to the payment).

10.2 Both parties may withdraw from the contract, however in addition to the provisions of Italian law Ekinex S.p.A. may also withdraw from the contract in the event of a force majeure event as specified in Article 7 of the general terms and conditions of sale prepared by Ekinex S.p.A..

Both parties must therefore communicate their intention to withdraw from the contract by registered letter or certified email and the withdrawal will take effect from the date of receipt of the communication.

10. COMPENSATION FOR DAMAGES

10.1. The liability of Ekinex S.p.A., whether arising from the execution or non-execution of the contract, from the warranty, from an illegal act or from an objective liability, shall not in any case exceed the value of the product to which this liability relates. Under no circumstances shall Ekinex S.p.A. be liable for loss of profit or loss of use or downtime of the product or any associated machinery, for claims by the Buyer and/or third parties relating to the aforementioned damages or for any other indirect or consequential damages.

11. CONFIDENTIALITY

11.1. The Purchaser agrees to (i) treat the information/data/documents/know how/documents received and/or learnt from Ekinex S.p.A. as confidential, (ii) limit the use of such confidential information/documents and the access to them for purposes related to the execution of the contract. Confidential information/documents may not be reproduced without the prior written consent of Ekinex S.p.A., and all copies of such information/documents shall be immediately returned upon request by Ekinex S.p.A..

The above provisions do not apply to information that: (i) is public or becomes public other than by disclosure by the Buyer, its employees or collaborators, or (ii) was in the possession of the Buyer before it was received by Ekinex S.p.A. or (iii) was disclosed by sources that are not subject to the restrictions to which the Buyer is subject regarding its use, or (iv) can be disclosed to third parties based on a written authorization of Ekinex S.p.A.

12. APPLICABLE LAW AND PLACE OF JURISDICTION

12.1. These General Conditions and the related supply contracts shall be governed by Italian law.

The Court of Novara shall have exclusive jurisdiction over any dispute relating to or in any case connected to the contracts to which these General Conditions apply.

13. COVID-19 CLAUSE

13.1 By signing this deed, the Purchaser declares that he is aware that the epidemiological emergency in progress due to the spread of the Coronavirus (Covid-19) and the regulations adopted to combat the aforementioned pandemic could have an effect on the fulfilment and execution of orders placed with Ekinex S.p.A..

13.2 Ekinex S.p.A. reserves the right to extend the terms, apply additional costs or amend these general terms and conditions of sale in the event that the condition referred to in the previous point occurs, after notifying the Purchaser.

14. CONTACTS

14.1 Indicate Ekinex's contact details + addresses for any communications.

15. VEXATIOUS CLAUSES

15.1 The customer expressly declares that he/she accepts and approves in accordance with articles 1341 and 1342 of the Civil Code the following clauses:
2. Applicable law and competent court: 5. Terms of payment: 6. Transport and delivery of products: 8. Guarantees: 10. Applicable law and competent court: 13 Covid-19 clause.

Summary

COMPANY	7
The automation of buildings	9
The KNX standard	10
The advantages	12
The Ekinex® devices	15

WALL-MOUNT DEVICES

SIGNUM	19
Signum Deep	22
Signum Surface	24
Signum pushbuttons	26

20VENTI SERIES	33
20venti Deep	36
20venti Surface	38
Pushbuttons	43
4/8-fold pushbutton with backlit text/symbols and proximity sensor	44
8-fold pushbutton with backlit text/symbols and proximity sensor for rectangular wall-box	45
5/10-fold pushbutton with backlit text/symbols and proximity sensor	46
10-fold pushbutton with backlit text/symbols and proximity sensor for rectangular wall-box	47

FF SERIES	49
FF Form	52
FF Flank	54
FF 'NF	56
FF Deep	58
FF Surface	60
Pushbuttons	63
4-fold basic pushbutton	64
4-fold pushbutton and room thermostat	65
6-fold pushbutton	66
Room thermostat	68
Easy room thermostat	72
Room thermostat	73
Room thermostat with relative humidity sensor	74
Touch&See	76
Touch&See display	80
Touch&See display with 2-fold pushbutton	81

71 SERIES	83
71 Form	86
71 Flank	88
71 'NF	90
71 Deep	92
71 Surface	94
Pushbuttons	97
4-fold basic pushbutton	98
4-fold basic pushbutton and room thermostat for rectangular wall-box	99
4-fold pushbutton and room thermostat	100
4-fold pushbutton and room thermostat for rectangular wall-box	101

General index

Room thermostat and multisensors	105
Room thermostat	106
Room thermostat for rectangular wall-box	107
Multisensor quality air with regulator	108
Multisensor quality air with regulator for rectangular wall-box	109
Multisensor with humidity, TVOC and CO2 eq. regulator	110
Multisensor with humidity, TVOC and CO2 eq. regulator for rectangular wall-box	111

TOUCH&CONTROL	113
Touch&Control 4"	119

HOTEL SOLUTIONS	123
Card reader	130
Card holder	131
Cards programmer	132
Desktop cards programmer kit	133
Accédo software	134
Smart-card	135
Tosibox® Lock router	136
USB Tosibox® Key	137

SENSORS	139
Motion sensor	142
KNX Secure multi-function movement sensor	143
KNX Secure multifunctional presence sensor	144
Motion sensor for outdoor mounting	145

POWER SOCKETS / KEYSTONE SYSTEM	147
Power sockets and USB	163
Power socket and USB A-C Italian version	164
Power socket and USB A-C Schuko version	165
Keystone system	168

ACCESSORIES	178
Rockers for pushbuttons 20venti series	180
Rockers for 4-fold pushbuttons FF series	181
Rockers for 6-fold pushbuttons and Touch&See FF series	182
Set 2 rockers for room thermostats FF series	183
Rockers for 4-fold pushbuttons 71 series	184
Full front cover for Multisensor	185

THERMOFORMED PROTECTION	
Thermoformed protection for Ekinex pushbuttons	186

FRAMES	
Square frame Form version	187
Rectangular frame Form version	187
Square frame Flank version	188
Rectangular frame Flank version	188
Double frame Form version	189
Double frame Flank version	189

PLATES	
Square plate	190
Adapter for square plate	190

General index

Rectangular plate	191
Adapter for rectangular plate	191
Double plate	192
Adapter for double plate	192
Deep square plate	193
Adapter for Deep square plate	193
Deep rectangular plate	194
Adapter for Deep rectangular plate	194
Deep double plate	195
Adapter for Deep double plate	195
Deep triple plate	196
Adapter for Deep triple plate	196
Surface square plate	197
Adapter for Surface square plate	197
Surface rectangular plate	198
Adapter for Surface rectangular plate	198
Surface double plate	199
Adapter for Surface double plate	199

TEMPLATES AND SUPPORTS

Template for Surface plates	200
Templates for installation of civil series components on 'NF/Deep applications	201
Square mounting support (devices not supplied by Ekinex)	201
Square mounting support	202
Rectangular mounting support	202
Template for side-by-side mounting of FF series with Form / Flank frames	203

SWISS MARKET

Solutions for the Swiss market	204
Mounting supports	211
Double plate with 68 or 71 mm centre distance window	212
Adapter for square plate and power socket (Feller)	213
Adapter for double plate	213

MATERIALS AND FINISHES

Colour solutions	214
Ekinex chooses Fenix NTM®	215

SYMBOLS CUSTOMIZATION

Symbols for rockers customization	216
Single symbols	217
Lighting	217
Multimedia	217
Health and care	217
Door and garage	218
Hotel	218
Energy	218
Climate	219
Scenarios	219
Markers	219
Double symbols	220
Customization with text	220

HOW TO ORDER A ROCKER

Rockers for pushbuttons 20venti series	221
Rockers for pushbuttons FF series	222
Kit 2 rockers for room thermostats FF series	223
Rockers for pushbuttons 71 series	224

HOW TO ORDER A FRONT COVER

Multisensors	226
Voice assistant	227
Keystone system	227
Power sockets	228
Power sockets USB	229

HOW TO ORDER A FRAME

Frame Form version	230
Frame Flank version	231

HOW TO ORDER A PLATE

SQUARE PLATE	232
RECTANGULAR PLATE	233
DOUBLE PLATE	234
DEEP SQUARE PLATE	236
DEEP RECTANGULAR PLATE	238
DEEP DOUBLE PLATE	239
DEEP TRIPLE PLATE	241
SURFACE SQUARE PLATE	242
SURFACE RECTANGULAR PLATE	243
SURFACE DOUBLE PLATE	244

DIN-RAIL MOUNT MODULES 247

Power supplies and System devices	250
640 mA bus power supply	251
1280 mA bus power supply	252
Time / astronomical digital switch	253
USB interface	254
Line / area coupler	255
IP secure interface	256
IP secure router	257

Universal interfaces 258

Configurable logical module	259
Universal interface 2 (4) IN, 2 (4) OUT	260
Universal interface 4 configurable IN, 4 OUT	261
Universal interface 4 IN, 2 OUT (relay 5A)	262
Load monitoring and control interface	263
Current transformer (TA) for EK-CF2-TP interface	264
Support for DIN-rail mounting	265
Spring for snapping on wall-mount devices	265

Inputs 266

8-fold binary input	267
---------------------	-----

Actuators 268

4-fold binary output	269
8-fold binary output	270
8-fold binary output / 4-fold blind actuator	271
16-fold binary output / 8-fold blind actuator	272

I/O Modules 273

Input/output module for office applications	274
Input/output module for hotel applications	275

Dimmers 276

KNX Dimmer 90-230V-50/60Hz	277
KNX Dimmer 90-230V-50/60Hz 4-channels	278
4-fold RGBW LED dimmer	279
4-fold 0-10 V actuator	280
Dimmer 90-230V- 50/60Hz	281

DALI Dimmers 282

DALI Dimmer 12 /48 Vdc	283
DALI Dimmer 90-230V-50/60Hz	284
DALI Dimmer 12 / 48V dc 4 channels	285
DALI Dimmer 90-230V-50/60Hz 4 channels	286

Thermoregulation 287

Fancoil actuator / controller 3-speed fan control	288
Fancoil actuator / controller 0-10 V fan control	289
Fancoil actuator / controller full version	290
8-fold actuator / controller for electrothermal valve drives	291
Mixing actuator	292
NTC 10 kΩ temperature sensors	293
Modbus / KNX interface for RDZ air handling units	294

Gateway 295

Gateway Modbus RS485 - KNX	296
Gateway Modbus TCP/IP - KNX	297
Gateway BACnet - KNX	298
Gateway DMX - KNX	299
Gateway M-Bus - KNX	300
Gateway PROFINET - KNX	301
Gateway DALI - KNX	302
Voice control interface - KNX	303
Konnect4 - KNX	304
KNX / DALI gateway 1 or 2 channels	305

Metering 307

Three-phase MID electricity meter 75A	308
Three-phase MID electricity meter 5A	309

Accessories for DIN-rail modules 310

Terminal blocks	310
Bus cable	311

SUPERVISION 313

Ekinex Delégo: the system	317
Renewed graphic interface	318
Simplified configuration and maintenance	321
Complete versatility	322
Main features - Licenses	323
Delégo server	324
Delégo mini	325
Delégo panel	326

AUDIO MULTIROOM SYSTEM 329

Streamer Amplifier 30W	342
Streamer amplifier 50Wx2	343
Streamer amplifier 80Wx2	344
Streaming amplifier 50Wx8	345
Wall-mounted speaker IP66 (pair)- black/white	347
2-way full-range in-ceiling speaker	348
Speaker Q series	349
Speaker R series	350
Speaker T series	351
Speaker Omni/Iride	352
Sub	353
Speaker Modulor	354
KNX-Sentio Gateway	355

IP DOOR PHONE 357

IP Door phone 5"	369
Dico Security Relay	372

LIFT TV 375

Under Bed Lift TV	384
Up & Down Lift TV	385

TOOLS 387

Planner	388
Bim	389

SALES KIT 391

Pocket Box	392
Color Ring	392
Glam Box	393
Color Box Pro	393
Style Box	394
Style Case	394
Lettering	395
Crowner	395
Tech Case	395

PROJECTING, CONFIGURATION AND COMMISSIONING 396

KNX Technology	398
Normative references	402
Energy efficiency in buildings	404

GENERAL TERMS OF SALE 407

CONTACTS 415

Ekinex® product catalogue - June 2024

The technical information included in this catalogue is to be deemed purely indicative.
The company reserves the right to modify any piece of information with no advance notice.

For installation, connection and commissioning of Ekinex® devices, please refer to the related technical documentation.

For the availability of Ekinex® products on your market, please contact the Ekinex® sales department (sales@ekinex.com).

© Ekinex S.p.A. The reproduction of any part of this catalog requires prior written consent of Ekinex S.p.A

Credits

Art direction	Marketing & Communication Ekinex®
Graphic Design	Marketing & Communication Ekinex®
Product development	R&D Ekinex®
Editing	R&D Ekinex®
Print	Tipolitografia Testori Snc
Photos	Architecture intérieure: agence Superstane, Lille (FR). Photo © Stéphane Waroczyk, 2019 Giorgio Possenti Vito Corvasce Alessandro Erbetta Nicola Morittu

CATEKINEXTEC24E

Contacts

Ekinex S.p.A.

Via Novara, 37

I-28010 Vaprio d'Agogna NO - ITALY

T +39 0321 1828980

info@ekinex.com

www.ekinex.com

Ekinex is member of:



www.ekinex.com